

**flexOvit**

Flexovit Hungária Kft.



**Szerszámok**

**2017**

## MÉRŐESZKÖZÖK

KOMELON MÉRŐSZALAGOK  
MÉRŐSZALAGOK ÉS MÉRŐESZKÖZÖK  
TOLÓMÉRŐ ÉS MÉRŐESZKÖZÖK  
ÁCSCERUZA HB ÉS FILCTOLL  
HORIZONT EXACTA VÍZMÉRTÉK  
HORIZONT VÍZMÉRTÉKEK ÉS ÖLESLÉCEK  
NIVELA VÍZMÉRTÉK  
DIGITÁLIS ÉS LÉZERES MÉRŐSZKÖZÖK  
LASERLINER

## INSTRUMENTE DE MASURA

**4** RULETE CU BANDA METALICA SI FIBRA STICLA KOMELON  
**6** RULETE SI ALTE INSTRUMENTE DE MASURA  
**9** SUBLER SI INSTRUMENTE DE MASURA  
**11** CREION TAMPLAR SI MARKERI  
**13** NIVELE SI DREPTARE HORIZONT EXACTA  
**14** NIVELE SI DREPTARE HORIZONT  
**17** NIVELA TIP NIVELA  
**17** NIVELE LASER SI DIGITALA  
LASERLINER

## SZERSZÁMOK

FOGÓK ÉS OLLÓK  
DUGÓKULCS KLT. ÉS RACSNIS  
KULCSOK  
CSAVARHÚZÓK ÉS BITEK  
STAHLBERG BEHAJTÓ HEGYEK  
KALAPÁCSOK, BALTÁK, VÉSŐK  
KÁRPITOS TŰZŐGÉPEK, KAPCSOK, SZORÍTÓK  
MUNKAPAD, SATU, POPSZEGECS FOGÓ  
ELEKTRÓDÁK, HEGESZTŐ PAJZSOK, MENETESSZÁRAK  
LEVEGŐPISZTOLYOK  
MUNKAVÉDELMI ESZKÖZÖK  
SZERSZÁM ÖV ÉS SZERSZÁMTÁSKA

## UNELTE

**19** CLESTI SI FOARFECI  
**27** SETURI CHEI TUBULARE SI FIXE  
**37** CHEI  
**41** CSAVARHÚZÓ  
**47** STAHLBERG BITURI  
**55** CIOCANE, TOPOARE, DALTI  
**62** CAPSATOARE, CLEME  
**64** MENGHINA, NITUITOARE  
**68** ELECTROZI, TIJE FILETATE  
**70** PISTOL CU AER  
**73** ECHIPAMENTEDE PROTECTIE  
**78** CENTURA SI GEANTA SCULE

## VÁGÓ ÉS CSISZOLÓ ESZKÖZÖK

KÉSEK KDS  
KÉSEK, TÖRDELHETŐ PENGÉJŰ KÉSEK  
CSŐVÁGÓK  
FÚRÓSZÁRAK, KÖRKIVÁGÓK, VÉSŐK  
LAPOS VÉSŐ, SPICCVÉSŐ  
CSIGAFÚRÓ FÁHOZ, FÚRÓ VÉGEK, KÖRKIVÁGÓ  
KÖRKEFE, CSAPOS, CSISZOLÓ  
FEMRESZELŐ, GYALU, RÁSPOLY  
FŰRÉSZEK, DEKOPIRFŰRÉSZ LAPOK  
DEKOPIRFŰRÉSZ, FŰRÉSZ

## UNELTE DE TAIAT SI SLEFUIT

**79** CUTTERE KDS  
**81** CUTTERE  
**89** DISPOZITIV PENTRU TAIAT TEVI  
**90** BURGHIE, CAROTE  
**99** DALTI, PUNCTATOR, DORN  
**100** BURGHIE LEMN, FREZE, COROANE  
**106** PERI ABRAZIVE, HARTIE ABRAZIVA  
**111** PILE, RASPILE  
**113** DISCURI DE TAIAT SI SLEFUIT, FIERASTRAU CIRCULAR  
**117** LAME DE FERA STRAU, FERA STRAIE

## KŐMŰVES SZERSZÁMOK

GLETTVASAK, SPAKLIK  
KŐMŰVES KANALAK, KAPARÓ  
SIMÍTÓK, CSISZILÓ RÁCS  
SIMÍTOK ÉS PÓT  
ELEKTROMOS FESTÉKKEVERŐ, KEVERŐSZÁR  
BETONKEVEŐ, TALICSKA,  
CSEMPEVÁGÓ  
ÉPÍTKEZÉSI KELLÉKEK ÉS ÉGŐ TÖMLŐ NÉLKÜL  
KŐMŰVES VÖDÖR, GIPSZELO EDÉNY, SZEMETESZSÁK  
KINYOMÓPISZTOLYOK, ECSET, FESTŐHENGER  
LETAKARÓ PONYVA, LÁNCOK, HALOGÉN LÁMPÁK

## SCULE PENTRU CONSTRUCTII

**124** MISTRI, SPA CLURI  
**129** CANCIOAGE, GLETIERE  
**131** GLETIERA LEMN, PLASTIC, PLASA ABRAZIVA  
**135** GLETIERE ÉS PÓT  
**139** PALETE MIXER  
**142** BETONIERA, TELEAGĂ SI ALTE UNELTE  
**146** MASINA DE TIAT PLACI  
**149** ARZATOARE SI CONSTRUCTII ACCESORII  
**157** GALETI SI ALTE UNELTE, SAC GUNOI SI BANDA ADHEZIVA  
**162** PISTOALE DE INJECTIE, PENSULE, TRAFALLET  
**170** PE PRELATE, LANȚURI ȘI CARABINER, LĂMPI CU HALOGEN

---

## KERTI SZERSZÁMOK UNELTE PENTRU GRADINARIT

WINLAND METSZŐOLLÓK	<b>175</b>	WINLAND FOARFECI	
METSZŐOLLÓK, MACETI	<b>177</b>	FOARFECI SI UNELTE PENTRU GRADINARIT	
LOMBSEPRŰ, KERTI SZERSZÁMOK, DAMILOK	<b>180</b>	GREBLA, ECHIPAMENTE PENTRU STROPIT, FIR DE TAIAT GAZON	
FÁTYOLFÓLIA, KOMPOSZTÁLÓ,	<b>183</b>	TESATURA SINTETICA, COMPOSTER	
ROSA LOCSOLÓ PISZTOLYOK, CSATLAKOZÓK	<b>186</b>	ROSA ECHIPAMENT PENTRU STROPIT	
KERTI HÁZ, KERTI TÁROLÓ, MELEGÁGY	<b>196</b>	ASPERSOR CĂSUȚĂ DE GRĂDINĂ, SERĂ	
ÚTTEST, ÁSOK, VILLÁK	<b>197</b>	MATURA, CAZMA, LOPETI,	
HÓLAPÁT, JÉGTÖRŐ, LAPÁTOK	<b>208</b>	LOPETI PENTRU ZAPADA, RACLETA GHEATA, HARLETE	
SZÚNYOGHÁLÓK, KERÍTÉSEK, KÖTÖZŐK	<b>213</b>	PLASE PENTRU INSECTE, GARDURI, SARME, CABLURI DE SARMA	
OSZLOPTALP, BAMBUS DEKORNÁD, ÁRNYÉKOLÓK	<b>216</b>	TARUS METALIC, PARAVAN BAMBUS, PLASA PLASTICGRATARE SI	
GRILL	<b>217</b>	ACCESORII PENTRU GRATARE	

---

## VASÁRUK ALTE SCULE

LAKATOK	<b>220</b>	LACATE	
POSTALÁDÁK, PÉNZES KAZETTÁK	<b>222</b>	CASUTE POSTALE, CUTI DE VALORI	
SPANIFER, RAKOMÁNYRÖGZÍTŐK, KÖTÉL , RAGASZTÓ PISZTOLY	<b>223</b>	CHINGI SI FRANGHII, FIR, PISTOL DE LIPIT	
KÁBELKÖTÖZŐ, TELESZKÓPOS RÚD, MÁŠ	<b>226</b>	BRIDE PLASTIC, TIJE TELESCOPICE ALTELE	
LED LÁMPÁK	<b>229</b>	LANTERNA PORTABILA CU LED	
TÁROLÓ ÁLLVÁNY, TARTOZÉKOK OZAB SUŠ	<b>230</b>	STANDURI SI SUPORTI OZAB SUŠ	
FALÉTRA	<b>234</b>	SCARĂ PLIANTĂ	
KUBALA KŐMŰVES SZERSZÁMOK	<b>235</b>	KUBALA SCULE PENTRU CONSTRUCTII	

---

## GARÁZSIPAR AUTOMOTIVE

HIDRAULIKUS EMELŐK, OLLÓS EMELŐ	<b>240</b>	CRICURI HIDRAULICE SI FOARFECI	
MOTOR KIEMELŐK, TÁMASZTÉKOK	<b>243</b>	CRICURI MACARA SI STANDURI MOBILE	
MOTORTARTÓ ÁLLVÁNY, KÉZI CSÖRLŐ	<b>244</b>	STATIV MOTOR, KÉZI CSÖRLŐ	
RUGÓ ÖSSZENYOMÓ, HIDRAULIKUS CSŐHAJLÍTÓ	<b>245</b>	PRESA ARCURI, LANT CU PIEDICA	
HIDRAULIKUS PRÉS, HIDRAULIKUS CSAPÁGYLEHÚZÓ	<b>246</b>	CRIC HIDRAULIC LUNG, HIDRAULIC PENTRU DEPRESARE	
FÁRADT OLAJ ELSZÍVÓ, ALKATRÉSZMOSÓ	<b>247</b>	SPALATOR PIESE, CABINA SABLARE	
SZERSZÁMOS SZEKRÉNY, FEKPAD GURULÓS	<b>248</b>	DULAP PENTRU SCULE, PAT MOBIL MECANIC	
MOTORTARTÓ ÁLLVÁNY, MODELLEK	<b>249</b>	SUPORT MINI PENTRU RIDICAT, MODELE	
CIKKSZÁM RENDEZŐ	<b>250</b>	LISTA PROD USELOR	

NYLON BURKOLAT		INVELIS NYLON
ROZSDAMENTES ACÉLBÓL		FABRICAT DIN OTEL INOXIDABIL
ALUMINIUM ÖTVÖZETBŐL		FABRICAT DIN ALUMINIU
KRÓM-VANÁDIUM ACÉLBÓL		FABRICAT DIN ALIAJ CROM-VANADIUM
KRÓM MOLIBDÉN ACÉL		FABRICAT DIN ALIAJ CROM-MOLIBDEN
NEMES ACÉL S2		FABRICAT DIN OTELURI S2 INALT ALIATE
NITRID TITAN		NITRID TITAN
ROCKWELL KEMÉNYSÉGE ANYAG		ROCKWELL DURITATEA MATERIAL
ÖTVÖZÖTT FÉM ACÉL SK5		LIGHEIRATE OȚEL SK5
TEFLON		TEFLON
HORGANYZOTT		ZINCARE
POLIÉSZTER		POLIESTER
PAMUT		BUMBAC
UV STABIL		UV STABILĂ
MÁGNESES MUNKAESZKÖZ RÉSZ		PARTE MAGNETICA A SCULEI DE LUCRU
GUMI ENDING		CAUCIUC ÎNCHEIEREA
PIELE		BŐR
CSOMAGOLÁSI DARABSZÁM		NUMAR BUCATI IN AMBALAJ
CSEH TERMÉK		FABRICAT IN CEHIA
EU TERMÉK		FABRICAT IN EU

# KOMELON®

nagyon pontos és kiváló minőségű mérőeszközök  
Instrumente de masura de inalta precizie si calitate

II. pontossági osztály a ČSN 251104, EEC 755345  
SZABVÁNYOKNAK MEGFELEL Tiszerte nagyobb  
kopásállóságú - új nylon DURA NY bevonatú felület.

II. Acuratete de clasa reg. CSN 251104, EEC 755345  
Rezistentă de 10x mai mare a învelisului din nylon  
DURA NY Coat

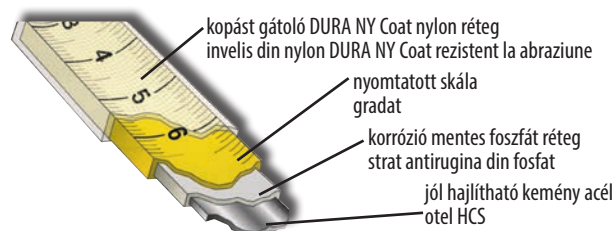

## MÉRŐSZALAGOK RULETA

KOMELON®



CE  
NYLON



10002	2 m · 16 mm	10
10003	3 m · 16 mm	10
10005	5 m · 19 mm	10
10008	8 m · 25 mm	10

10
10
10
10

## MÉRŐSZALAGOK RULETA

KOMELON®



CE  
NYLON



10025	5 m · 25 mm	10
-------	-------------	----

10
----

## MÉRŐSZALAGOK RULETA

KOMELON®



CE  
NYLON



10033	3 m · 16 mm	6
10035	5 m · 19 mm	6

6
6

## MÉRŐSZALAGOK RULETA

KOMELON®



CE



10043	3 m · 16 mm	30
10045	5 m · 19 mm	30
10048	8 m · 25 mm	24

30
30
24

## ACÉL MÉRŐSZALAG RULETA METALICA

KOMELON®



CE  
NYLON



10110	10 m · 10 mm	6
10120	20 m · 10 mm	6
10130	30 m · 10 mm	6

6
6
6

## MŰ.A MÉRŐSZALAG RULETA FIBRA STICLA

KOMELON®



CE



10330	10 m · 13 mm	6
10332	20 m · 13 mm	6
10334	30 m · 13 mm	6
10336	50 m · 13 mm	6

6
6
6
6

MŰ.A MÉRŐSZALAG  
RULETA FIBRA STICLA

KOMELON®



<b>10430</b>	30 m · 13 mm	5
<b>10450</b>	50 m · 13 mm	5
<b>10490</b>	100 m · 13 mm	5

ÁLLVÁNY  
STAND PROMOTIONAL



**10998**

1

KOMELON ÁLLVÁNY  
STAND PROMOTIONAL KOMELON

KOMELON®



**10996**-Töltött elemek  
Stativ umplut cu elemente  
10003, 10005, 10008,  
10033, 10035, 10045,  
10025, 10010, 10120,  
10130, 10430, 10330,  
10332, 10334, 10336

illusztrációs fotó /  
Imagine ilustrativa



<b>10999</b>	állvány	1
<b>10996</b>	állvány töltött elemek / stativ umplut cu elemente	1

MÉRŐSZALAGOK  
RULETA

FESTA®



mágneses végződés / fixare magnetica



11102	2 m · 16 mm	10
11103	3 m · 16 mm	10
11105	5 m · 19 mm	10
11107	7,5 m · 25 mm	10
11110	10 m · 25 mm	10

MÉRŐSZALAGOK  
RULETA

FESTA®



EEC Certifikát,  
automatikus fék, gumizott  
Certificare EEC,  
frana automata, cauciucata



11333	3 m · 16 mm	10
11335	5 m · 19 mm	10
11337	7,5 m · 25 mm	10

MÉRŐSZALAGOK  
RULETA

FESTA®



fékezés /inchidere



11082	2 m · 16 mm	12
11083	3 m · 16 mm	12
11085	5 m · 19 mm	12

MÉRŐSZALAGOK  
RULETA

FESTA®



11200	2 m · 13 mm	24	11206	3 m · 19 mm	24
11201	2 m · 16 mm	24	11207	5 m · 19 mm	12
11202	2 m · 19 mm	24	11209	7,5 m · 25 mm	12
11204	3 m · 13 mm	24	11210	10 m · 25 mm	12
11205	3 m · 16 mm	24			

MÉRŐSZALAGOK  
RULETA

FESTA®



11413	3 m · 16 mm	12
-------	-------------	----

MÉRŐSZALAGOK  
RULETA

FESTA®



3x fék, mágneses végződés  
3x frana, fixare magnetica



11323	3 m · 16 mm	10
11325	5 m · 19 mm	10
11327	7,5 m · 25 mm	10

MÉRŐSZALAGOK  
RULETA

Johnney®



EEC Certifikát, szalag matt kivitelezése /  
Certificare EEC, ajustare fina a benzii



11002	2 m · 13 mm	12	11006	5 m · 19 mm	12
11003	3 m · 13 mm	12	11007	7,5 m · 19 mm	12
11005	5 m · 13 mm	12			

MÉRŐSZALAGOK  
RULETA

FESTA®



skálázás nagy számjegyekkel /  
scala cu cifre mari



11226	2 m · 16 mm	10
11239	3 m · 19 mm	10
11259	5 m · 19 mm	10

MÉRŐSZALAGOK  
RULETA

FESTA®



INOX

EEC Certifikát / Certificare EEC



11215	2 m · 16 mm	10
11216	3 m · 16 mm	10
11218	5 m · 19 mm	10

MÉRŐSZALAGOK  
RULETA



kombinált metrikus és angol collos skálázás /  
combinatie de sistem metric si inch



11416	5 m · 19 mm	10
-------	-------------	----

ÜVEGSZALÁS MÉRŐSZALAG  
RULETA CU BANDA FIBRA STICLA

FESTA®



EEC Certifikát / Certificare EEC



12201	10 m · 13 mm	1
12202	20 m · 13 mm	1
12203	30 m · 13 mm	1
12205	50 m · 13 mm	1

ÜVEGSZALÁS MÉRŐSZALAG  
RULETA CU BANDA  
FIBRA STICLA

FESTA®



EEC Certifikát / Certificare EEC



12110	10 m · 14 mm	10
12120	20 m · 14 mm	6
12130	30 m · 14 mm	6
12150	50 m · 14 mm	6

ACÉL MÉRŐSZALAG NYÍTOTT  
RULETA CU BANDA METAL

FESTA®



EEC Certifikát / Certificare EEC



12433	30 m · 12,5 mm	10
12435	50 m · 12,5 mm	10

MÉRŐKERÉK  
ROATA DE MASURARE A DISTANTEI



15989	max. 10 km	4
-------	------------	---

MÉRŐSZALAG  
RULETA  
CU BANDA  
METAL

FESTA®



12010	10 m · 10 mm	10
12020	20 m · 10 mm	10
12030	30 m · 10 mm	5
12050	50 m · 10 mm	5

MÉRŐSZALAG  
RULETA CU BANDA  
METAL

FESTA®



EEC Certifikát / Certificare EEC  
szem+horog/sistem fixe



12210	10 m · 10 mm	6
12220	20 m · 10 mm	6
12230	30 m · 10 mm	6
12250	50 m · 10 mm	6

TELESZKÓPOS HOSSZMÉRŐ  
DISPOZITIV TELESCOPIC PENTRU MASURAT

FESTA®



15983	0,7 · 3 m	10
15985	1,1 · 5 m	10
15988	1,6 · 8 m	5



STOJAN NA SKLÁDACÍ METRY  
STAND FOR FOLDING RULE

NEW



## 13399-Osazeno položkami

13401, 13402, 13403,  
13404, 13405, 13406,  
13407, 13408, 13409, 13410,  
13411, 13412, 13413, 13414,  
13415, 13416, 13417, 13418,  
13419, 13420, 13421, 13422,  
13423, 13424, 13425, 13426,  
13427, 13428, 13429, 13430,  
13431, 13432, 13433, 13434,  
13435, 13436, 13437, 13438,  
13439, 13440,



13399 Stojan na skládací metry OSAZENÝ 1  
13400 Stojan na skládací metry se jmény 1

13401	2m	JIŘÍ
13402	2m	JAN
13403	2m	PETR
13404	2m	JOSEF
13405	2m	PAVEL
13406	2m	MARTIN
13407	2m	JAROSLAV
13408	2m	TOMÁŠ
13409	2m	MIROSLAV
13410	2m	ZDENĚK
13411	2m	FRANTIŠEK
13412	2m	VÁCLAV
13413	2m	MICHAL
13414	2m	MILAN
13415	2m	KAREL
13416	2m	JAKUB
13417	2m	LUKÁŠ
13418	2m	DAVID
13419	2m	VLADIMÍR
13420	2m	LADISLAV
13421	2m	ONDŘEJ
13422	2m	ROMAN
13423	2m	STANISLAV
13424	2m	MAREK
13425	2m	RADEK



III. třída přesnosti / III. accurate class



13426	2m	DANIEL	13450	2m	ZDENKO
13427	2m	ANTONÍN	13451	2m	JANA
13428	2m	VOJTĚCH	13452	2m	EVA
13429	2m	FILIP	13453	2m	PETRA
13430	2m	ADAM	13454	2m	MAJKA
13431	2m	MILOSLAV	13455	2m	HANA
13432	2m	MATĚJ	13456	2m	ANNA
13433	2m	ALEŠ	13457	2m	LENKA
13434	2m	JAROMÍR	13458	2m	KATKA
13435	2m	LIBOR	13459	2m	LUCIE
13436	2m	DOMINIK	13460	2m	ALENA
13437	2m	PATRIK	13461	2m	VERONIKA
13438	2m	VLASTIMIL	13462	2m	MARTINA
13439	2m	JINDŘICH	13463	2m	JITKA
13440	2m	MILOŠ	13464	2m	BIG BOSS
13441	2m	JÁN	13465	2m	2x MĚŘ
13442	2m	PETER	13466	2m	TATÍNEK
13443	2m	ONDŘEJ	13467	2m	DĚDEČEK
13444	2m	JOSEF	13468	2m	ŠIKULA
13445	2m	PAVEL	13469	2m	MISTR
13446	2m	L'UBOMÍR	13470	2m	MACHR
13447	2m	KAROL	13471	2m	BOREC
13448	2m	RADOSLAV	13472	2m	UŽ JE MŮJ
13449	2m	VOJTECH	13473	2m	MŮJ METR

PROFI FAMÉRCE  
PROFI METRU TAMPLARIE LEMN

III. pontosságú osztály / III. precizie ridicata



13010	1 m	• fehéř / alb	20
13020	2 m	• fehéř / alb	10
13021	1 m	• sárga / galben	20
13022	2 m	• sárga / galben	10
13023	2 m	• fehéř-sárga / alb-galben	10
13030	3 m	• fehéř / alb	10

FAMÉRCE  
METRU TAMPLARIE LEMN

13111	1 m	10
13120	2 m	5

MÉRŐVESSZŐ, MŰ.A  
METRU TAMPLARIE PLASTIC

13210	1 m	mini	1
13211	1 m		1
13220	2 m		1

MÉRŐSZALAG  
RULETA BRELOC CHEI

11420	1 m • 6 mm	Rosu	24
11444	1 m • 6 mm	Alb	24

MÉRŐSZALAG  
RULETA BRELOC CHEI

11425	1 m • 6 mm	50
-------	------------	----

KULCSTARTÓ LIBELLA  
BRELOC FIOLA

11445	100
-------	-----

TOLÓMÉRŐ  
SUBLER

FESTA®

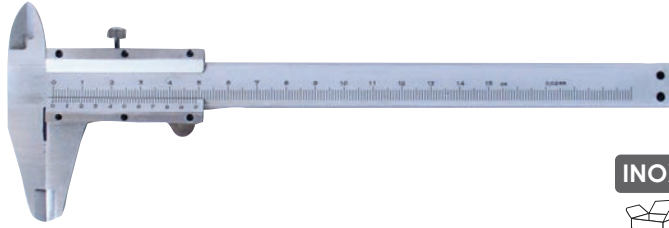

INOX



14001	150/0,02 mm	10
14002	200/0,02 mm	10
14003	300/0,02 mm	10

DIGITÁLIS TOLÓMÉRŐ  
SUBLER DIGITAL

FESTA®

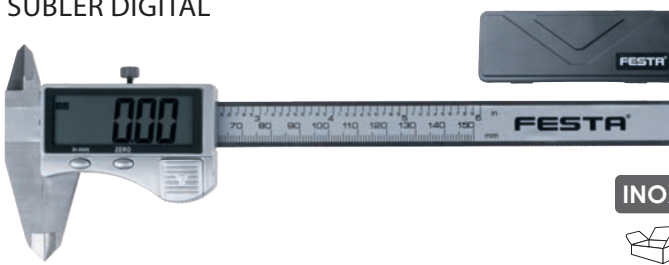

INOX



14007	150/0,01 mm	10
14008	200/0,01 mm	10
14009	300/0,01 mm	10

ACÉL VONALZÓ  
RIGLA INOX



INOX



14010	300 mm	10
14011	600 mm	20
14012	1000 mm	20

INDIKÁTOR ÓRA  
CEAS COMPARATOR

FESTA®



INOX



14035	0,01 mm, 0-10 mm	10
-------	------------------	----

HÉZAG MÉRŐ  
LERE PENTRU GROSIME



14080	0,05 - 1 mm • 20 listű / leaves	10
-------	---------------------------------	----

TOLÓMÉRŐ  
SUBLER

FESTA®

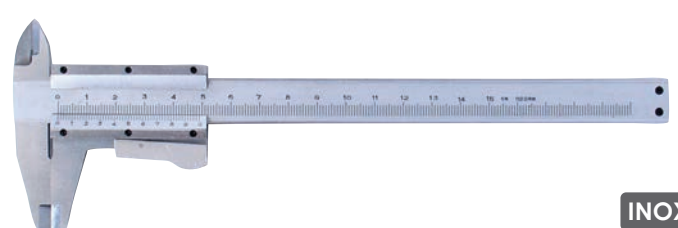

INOX



14004	150/0,02 mm	10
-------	-------------	----

TOLÓMÉRŐ  
SUBLER

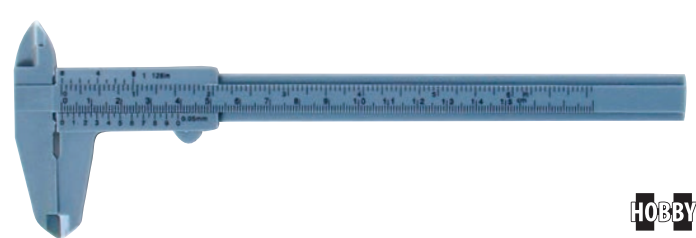

HOBBY



14006	tolómérő műanyag/plast 150/0,1 mm	50
-------	-----------------------------------	----

ALU VONALZÓ  
RIGLA ALU



ALU



14015	400 mm	48
14017	600 mm	48
14019	1000 mm	40

MIKROMÉTER  
MICROMETRU

FESTA®



INOX



14040	0-25/0,01 mm	10
14045	25-50/0,01 mm	10

SZÖGMÉRŐ FORGÓ KARRAL  
RAPORTOR



INOX



14060	0°-180° • 150x200 mm	10
14070	0°-180° • 300x500 mm	5

SZÖGMÉRŐ  
RAPORTOR

14075 0°-180° • 230x500 mm

HOBBY



30

ASZTALOS DERÉKSZÖG  
ECHER ALUMINIU

FESTA®



14220	200 x 125 mm	14235	350 x 190 mm	10
14225	250 x 135 mm	14240	400 x 190 mm	10
14230	300 x 135 mm	14250	500 x 210 mm	10

ÁCS DERÉKSZÖG  
ECHER TAMPLARIE

FESTA®



14350	500x250 mm	10
14360	600x300 mm	10
14370	700x300 mm	10
14380	800x320 mm	10
14399	1000x360 mm	10



10

10

10

10

10

DERÉKSZÖG  
ECHER

14410	300x200 mm	50
14411	600x400 mm	36



50

36

DERÉKSZÖG  
ECHER ALUMINIU

14425	250 mm	12
14430	300 mm	12
14435	350 mm	12
14440	400 mm	12

HOBBY



12

12

12

12

SZÖGMÁSOLÓ  
ECHER REGLABIL

14025 270 mm



1

LAKATOS DERÉKSZÖG FELÜLETKEZELT  
ECHER PLAT

Zn



14471	150 x 100 • tl. 5 mm	25
14472	250 x 125 • tl. 5 mm	25
14473	400 x 200 • tl. 5 mm	30
14474	600 x 300 • tl. 5 mm	25

TALPAS DERÉKSZÖG FELÜLETKEZELT  
ECHER CU TALPA

Zn



14490	100 x 50 • tl. 5 mm	10
14491	150 x 75 • tl. 5 mm	10
14492	250 x 125 • tl. 5 mm	10
14493	400 x 200 • tl. 5 mm	10
14494	600 x 300 • tl. 5 mm	10

DERÉKSZÖG  
ECHER ZIDARIE

14455	300 x 200 mm	50
14456	500 x 250 mm	50
14457	700 x 300 mm	40
14458	1000 x 450 mm	30



50

50

40

30

DERÉKSZÖG  
ECHER  
REGLABIL

14450	350 mm	6
14451	400 mm	6

ALU



6

6

ÁCSCERUZA HB  
CREION TAMPLAR HB

FESTA®



13266	HB · 250mm · 50 db/buc	30
13269	HB · 180mm · 50 db/buc	30

ÁCSCERUZA HB  
CREION TAMPLAR HB



fehér négyszögletes / exterior alb

13272	HB · 250 mm	12
<b>NEW</b> 13264	HB · 250 mm nyomtatás nélkül / fără imprimare	12

ÁCSCERUZA  
CREION TAMPLAR



13274	kétszínű / rosu-albastru	12
13276	ÁCsceruza piros színű / rosu grafit	12

JELŐLŐ FILC  
MARKER ALB

FESTA®

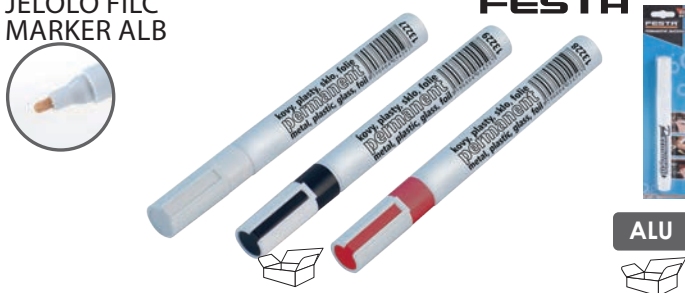

ALU

13227	fehér/alb	12	<b>NEW</b> 13230	kék/albastru	12
13228	piros/roșu	12	<b>NEW</b> 13231	zöld/green	12
13229	fekete/negru	12			

ALKOHOLOS FILCTOLL  
MARKER PERMANENT



13235	piros/roșu	12
13236	fekete/negru	12

ÁCSCERUZA HB  
CREION TAMPLAR HB

FESTA®



13270	HB · 180 mm	144
13271	HB · 180 mm · 3 db/buc	24
13265	HB · 250mm	72

ÁCSCERUZA 6H  
CREION TAMPLAR 6H



13275	6H · 250 mm ceruza kőre / creion pentru piatra	12
13273	üvegre és kerámiára (piros) / pentru sticla și ceramica	12

ÁCSCERUZA  
CREION TAMPLAR



**Alkalmas:** téglá, fém, fa, üveg, műanyag,

**Potrivit pentru:** cărămizi, metal, lemn, sticla, materiale plastice, ceramice

13240	5 színek/5colorate	12	13243	sárga/galben	12
13241	piros/roșu	12	13244	zöld/verde	12
13242	fekete/negru	12	13245	fehér/alb	12

ALKOHOLOS FILCTOLL  
MARKER PERMANENT



<b>NEW</b> 13222	fehér/alb	12	<b>NEW</b> 13223	kék/albastru	12
13225	piros/roșu	12	<b>NEW</b> 13224	zöld/verde	12
13226	fekete/negru	12			

ÁCSCERUZA KÉSZLET  
CREION CEARA



13277	6 db/buc	24
-------	----------	----

KRÉTA, FEHÉR  
CRETĂ ALBĂ



13260 10x10x100mm • 12db/buc



RAJZTŰ, VÉSŐ TŰ  
CREIŢON TRASARE

FESTA®



13281 150 mm



KÖRZŐ  
COMPAS DE TRASAT



13285 200 mm



RAJZTŰ, VÉSŐ TŰ  
CREIŢON TRASARE

FESTA®



13282 200 mm



SPRAY FLUORESCENT FLUO 500 ml  
SPRAY FLUORESCENT FLUO 500 ml

NEW

- Jó láthatóság miatt fluoreszkáló pigmentet / vizibilitate ridicată datorită pigment fluorescent
- Biztonsági kupak / capac de siguranță
- Gyors száradás 10 perc. / uscare rapida 10 min.
- Gyors száradás 10 perc. / Durabilitate 12 luni
- Használat - beton, aszfalt, fű, kavics, homok, kő, fa / Utilizare - beton, asfalt, iarbă, pietriș, nisip, piatră, lemn

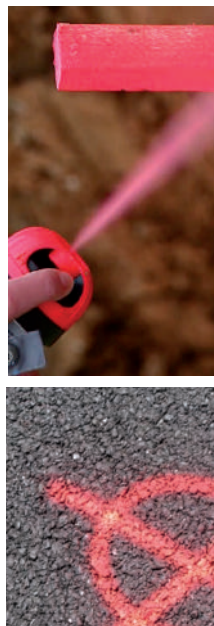

13250	sárga/ galben	20
13251	piros/ roșu	20
13252	narancs / portocale	20
13253	zöld/ verde	20
13254	rózsaszín / roz	20

SPRAY FLUORESCENT IDEAL 500 ml  
SPRAY FLUORESCENT IDEAL 500 ml

NEW

- Jó láthatóság miatt fluoreszkáló pigmentet / vizibilitate ridicată datorită pigment fluorescent
- Mnohosmerný dávkovač o rozsahu 360° / Multidirectional dispenser on the scope of 360°
- Gyors száradás 5 perc. / uscare rapida 5 min.
- Gyors száradás 9 - 10 perc. / Durabilitate 9 - 12 luni
- Használat - beton, aszfalt, fű, kavics, homok, kő, fa / • Utilizare - beton, asfalt, iarbă, pietriș, nisip, piatră, lemn

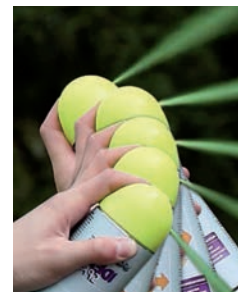

13255	sárga / galben	20
13256	piros / roșu	20
13257	narancs / portocale	20
13258	zöld / verde	20
13259	rózsaszín/ roz	20

# HORIZONT<sup>®</sup> EXACTA

Precíz vízmértékek a legmagasabb pontossággal • Nivele de precizie cu grad mare de acuratete

- pontosság 0,3 mm/1 m = 0,017° (normál pozícióban)** -  - **acuratete 0,3mm/1m = 0,017° (in pozitie normala)**
- erősített profil, vastagság 2,2 mm -  - profil rigid - grosime 2,2mm
- 2% lejtés beállítható -  - inelele permit alinierea la inclinatia de 2%
- UV álló libella folyadék -  - fluidul din fiola este rezistent la radiatii UV
- foszforeszkáló folyadék, jobb láthatóság -  - fluidul din fiola este fluorescent pentru o vizibilitate mai buna
- optikális libella növeli a pontosságot -  - optica fiolei permite cresterea gradului de acuratete
- külső behatásoknak ellenálló -  - nivele este rezistentă la deformari
- 30 év garancia a libellákra** -  - **30 de ani garantie pentru fiole**

minden termék elektromossan tesztelt, nyilvántartási számmal ellátott -  
ISO 90001 tanúsítással rendelkező gyártó -

- fiecare bucata este testata electronic si are numar de serie  
- producatorul este detinatorul certificatului ISO 90001

## EXACTA VÍZMÉRTÉK 2 LIBELLÁS NIVELE EXACTA CU 2 FIOLE



15033 60 cm

ALU



10

## EXACTA VÍZMÉRTÉK 3 LIBELLÁS NIVELE EXACTA CU 3 FIOLE



15034 80 cm  
15035 100 cm

ALU



10

10

## EXACTA VÍZMÉRTÉK 3 LIBELLÁS, 2 FOGANTYÚS NIVELE EXACTA CU 3 FIOLE, 2 MANERE



15036 120 cm  
15037 150 cm  
15039 200 cm

ALU









10

10

10

# HORIZONT®

Nivele si dreptare pentru zidarie / Pontos libellás vízszintezők és lecek

- acuratete 0.5mm/1m = 0.0285° -  - pontosság 0,5 mm/1 m = 0,0285°
- invelis elox - rezistent la zgarieturi - grosime de 1,5mm -  - eloxált felület, korrozio ellenálló, vastagság 1,5 mm
- fluidul din fiole este rezistent la radiatii UV -  - UV álló libella folyadék
- fluidul din fiole este fluorescent pentru o mai buna vizibilitate -  - foszforeszkáló folyadék, jobb láthatóság
- optica fiolei creste gradul de acuratete -  - optikális libella növeli a pontosságot
- nivelele sunt rezistente la deformari -  - külső behatásoknak ellenálló
- 10 ani garantie pentru fiole -**  **- 10 év garancia a libellákra**

Fiecare bucata este testata electronic si are numar de serie -  
Porducatorul este detinatorul certificatului ISO 90001 -

- minden termék elektromossan tesztelt, nyilvántartási számmal ellátott  
- ISO 90001 tanúsítással rendelkező gyártó

## VÍZMÉRTÉK 2 LIBELLÁS NIVELA ALUMINIU 2 FIOLE



Model	Length	Weight
15003	30 cm	30
15004	40 cm	30
15005	50 cm	30
15006	60 cm	30
15008	80 cm	30
15010	100 cm	30
15012	120 cm	10
15015	150 cm	10
15018	180 cm	10
15020	200 cm	10

## VÍZMÉRTÉK 3 LIBELLÁS NIVELA ALUMINIU 3 FIOLE



Model	Length	Weight
15103	30 cm	30
15104	40 cm	30
15105	50 cm	30
15106	60 cm	30
15108	80 cm	30
15110	100 cm	30
15112	120 cm	10
15115	150 cm	10
15118	180 cm	10
15120	200 cm	10

## VÍZMÉRTÉK 2 LIBELLÁS+MÁGNES NIVELA ALUMINIU 2 FIOLE + MAGNETI FIXARE



Model	Length	Weight
15204	40 cm	30
15205	50 cm	30
15206	60 cm	30
15208	80 cm	30
15210	100 cm	30
15212	120 cm	10
15215	150 cm	10
15218	180 cm	10
15220	200 cm	10

LEJTŐ VÍZMÉRTÉK 4 LIBELLÁS  
NIVELA PENTRU INCLINATII 4 FIOLE



ALU

a 0°, 1° és 2° fok beállítására  
pentru ajustarea pantei de 0°, 1° la 2°

ALU



15230 80 cm

30

SZÖGMÉRŐS VÍZMÉRTÉK  
NIVELA PENTRU INCLINATII



ALU



15235 60 cm

1

ÖLESLÉC  
DREPTAR ALU



ALU



15310	100 cm
15315	150 cm
15318	180 cm
15320	200 cm
15325	250 cm
15330	300 cm
15335	350 cm
15340	400 cm

10

10

10

10

10

10

10

10

ÖLESLÉC 1 LIBELLÁS  
DREPTAR ALU 1 FIOLA



ALU



15415	150 cm
15418	180 cm
15420	200 cm
15425	250 cm
15430	300 cm

10

10

10

10

10

ÖLESLÉC 2 LIBELLÁS  
DREPTAR ALU 1 FIOLA



ALU



15510	100 cm
15515	150 cm
15518	180 cm
15520	200 cm
15525	250 cm
15530	300 cm
15535	350 cm
15540	400 cm

10

10

10

10

10

10

10

10



### ÖLESLÉC 2 FOGANTYÚS DREPTAR ALU 2 MANERE



ALU



<b>15615</b>	150 cm	10
<b>15620</b>	200 cm	10
<b>15625</b>	250 cm	10
<b>15630</b>	300 cm	10

### ÖLESLÉC 2 LIBELLÁS DREPTAR ALU 2 FIOLE + 2 MANERE



ALU



<b>15710</b>	100 cm	10
<b>15715</b>	150 cm	10
<b>15720</b>	200 cm	10
<b>15725</b>	250 cm	10
<b>15730</b>	300 cm	10
<b>15735</b>	350 cm	10
<b>15740</b>	400 cm	10

### LEHÚZÓLÉC, TRAPÉZ ALAKÚ DREPTAR ALU PROFIL TRAPEZ



ALU



<b>15810</b>	100 cm	10
<b>15812</b>	120 cm	10
<b>15815</b>	150 cm	10
<b>15818</b>	180 cm	10
<b>15820</b>	200 cm	10
<b>15825</b>	250 cm	10
<b>15830</b>	300 cm	10

### LEHÚZÓLÉC, h ALAKÚ DREPTAR ALU PROFIL h



ALU



<b>15850</b>	100 cm	10
<b>15853</b>	150 cm	10
<b>15855</b>	180 cm	10
<b>15860</b>	200 cm	10
<b>15870</b>	250 cm	10
<b>15880</b>	300 cm	10

### HORIZONTAL BEMUTATÓ ÁLLVÁNY STAND PENTRU NEVELE HORIZONTAL

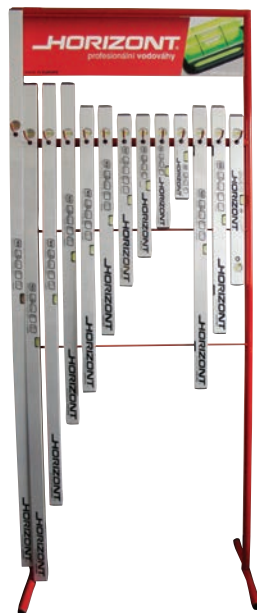

**15998 - Töltött elemek**  
**Stativ umplut cu elemente**  
15003, 15004, 15005,  
15006, 15008, 15010,  
15012, 15015, 15018,  
15020, 15108, 15206,  
15210

<b>15999</b>	85 x 210 x 50 cm	1
<b>15998</b>	pengével/ brut	1



### HORIZONTAL BEMUTATÓ ÁLLVÁNY STAND PENTRU NEVELE HORIZONTAL



**15996 - Töltött elemek**  
**Stativ umplut cu elemente**  
15004, 15005, 15006,  
15008, 15010, 15012,  
15015, 15018, 15020,  
15315, 15320, 15325,  
15515, 15520, 15525

<b>15996</b>	pengével/ brut	1
<b>15997</b>	550 x 750 x 400 mm	1



### VÍZMÉRTÉK NIVELA NIVELA TIP NIVELA

pontosság / acuratete 1 mm/1 m



ALU



15904	40 cm	30
15906	60 cm	30
15908	80 cm	30
15910	100 cm	30
15912	120 cm	10
15915	150 cm	10
15920	200 cm	10

### SZÖGMÉRŐS VÍZMÉRTÉK NIVELA CU UNGHI

pontosság / acuratete 1 mm/1 m



ALU



15901	80 cm	30
15902	100 cm	30

### SÁRGA VÍZMÉRTÉK, 3 LIBELLÁS NIVELA ALU, GALBENA, 3 FIOLE

HOBBY

ALU



15954	40 cm	60
15956	60 cm	60
15958	80 cm	60
15960	100 cm	60
15962	120 cm	60
15965	150 cm	60
15970	200 cm	60

### SZINTEN DIGITÁLIS SZÖGMÉRŐK NIVEL CU DIGITAL PROTRACTOR

FESTA®

NEW

LCD Displej / LCD kijelző  
 Rozsah Měření / Měření úhla od 0° do 22925°  
 Rozlišení / Digitální rozlišení 0,1°  
 Přesnost / Přesnost ±0,3; Přesnost 0,5 mm/m,

pontosság / acuratete 0,5mm/1 m  
felbontása / rezolutie 0,1°

ALU



26216	30 cm	6
-------	-------	---

### NIVELA DIGITÁLIS VÍZMÉRTÉK DL NIVELA DIGITALA DL

pontosság / acuratete 0,5mm/1 m  
felbontása / rezolutie 0,1°  
profil vastagsága / profil 1,8 mm

26215	60 cm	6
-------	-------	---

▼ LÉZERES VÍZMÉRTÉK  
NIVELA LASER

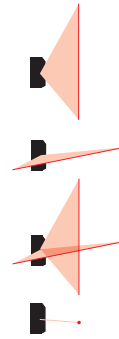

650 nm, 400 mm,  
pontosság 0,5mm/1 m,  
3 nyaláb, tartó koffer

acuratete 0,5mm/1 m,  
set cu 3 plane



26210

4

▼ LÉZERES MÉRŐ, 2 FÜGGŐLEGES SÍKHOZ SA-08  
NIVELA LASER IN CRUCE

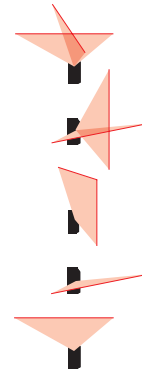

650 nm, 2x AA elem,  
munka hatótávolság 10 m

650 nm, 2x AA baterie,  
raza de actiune 10 m



26205

6

▼ ÁLLVÁNY  
TREPIED



26221 100 cm

1

▼ LEVEL EGY HÚR  
NIVELUL PE UN ȘIR DE CARACTERE



15981

1

▼ MÁGNESES VÍZMÉRTÉK, 3 LIBELLÁS  
NIVELA PLASTIC 3 FIOLE + MAGNETI FIXARE



15980

10

▼ VÍZMÉRTÉK OSZLOPHOZ  
NIVELA CU FIOLA  
PENTRU MIRE



3 libellás mágneses rögzítőöv/  
3 fiole magneti curea

26028

1

▼ SLAGVÍZMÉRTÉK TÖMLŐVEL  
FURTUN CU FIOLE DE NIVEL



15992	üveg csövek - tömlő 10 m / fiole + furtun de 10m	1
15993	üveg csövek - tömlő 15 m / fiole + furtun de 15 m	1
15990	slagvízmérték üveg / fiole de sticla	50
15991	slagvízmérték műanyag / fiole de plastic	50

# FESTA®

FESTA ERGONOMIC



STANDARD HANDLE



**Kiváló minőségű fogó**  
Az alkatrészek korróziógátló bevonata  
Ergonomikus puha TPR markolat  
a termelő birtokában van az ISO 9001 tanúsítvány  
Mintegy 30% -kal több a kapcsolat a fogantyú csökkenti  
mennyiségű energia szükséges

**clește de calitate înaltă**  
acoperire anticorrosivă  
Ergonomică mânăre TPR moale  
producătorul este titularul certificatului ISO 9001  
Aproximativ 30% mai mult contact cu mânerul, reduce

## KOMBINÁLT FOGÓ CrV CLESTE COMBINAT CrV

FESTA®



CrV



<b>17101</b>	160 mm	6
<b>17102</b>	180 mm	6
<b>17103</b>	200 mm	6

## OLDALCSÍPŐ FOGÓ CrV CLESTE SFIC CrV

FESTA®



CrV



<b>17104</b>	160 mm	6
<b>17105</b>	180 mm	6

## TELEFON FOGÓ, EGYENES CLESTE CU FALCI ASCUTITE LUNGI

FESTA®

HRC 58-62

NEW



CrV



<b>17140</b>	160 mm	6
<b>17141</b>	180 mm	6
<b>17142</b>	200 mm	6

## TELEFON FOGÓ, HAJLÍTOTT CLESTE CU FALCI ASCUTITE LUNGI

FESTA®

HRC 58-62

NEW



CrV



<b>17145</b>	160 mm	6
<b>17146</b>	200 mm	6

## KOMBINÁLT FOGÓ CLESTE COMBINAT

FESTA®



<b>17001</b>	160 mm	6
<b>17002</b>	180 mm	6
<b>17003</b>	200 mm	6

## OLDALCSÍPŐ FOGÓ CLESTE SFIC

FESTA®



<b>17004</b>	160 mm	6
<b>17005</b>	180 mm	6

## ERŐSÍTETT OLDALCSÍPŐ FOGÓ CLESTE SFIC

FESTA®



<b>17108</b>	200 mm	6
--------------	--------	---

## HOMLOKCSÍPŐ FOGÓ CLESTI DE TAIERE

FESTA®



<b>17110</b>	160 mm	6
--------------	--------	---

TELEFON FOGÓ, EGYENES  
CLESTE CU FALCI ASCUTITE LUNGI

FESTA®



17006	160 mm	6
17018	180 mm	6
17011	200 mm	6



TELEFON FOGÓ, HAJLÍTOTT  
CLESTE CU FALCI ASCUTITE LUNGI

FESTA®



17007	160 mm	6
17008	200 mm	6



LAPOS FOGÓ  
CLESTE CU FALCI PLATE LUNGI

FESTA®



17009	160 mm	6
-------	--------	---



SZEMES FOGÓ  
CLESTE CU FALCI ROTUNDE LUNGI

FESTA®



17010	160 mm	6
-------	--------	---



FOGÓ KÁBELCSUPASZÍTÓ  
CLESTE DEZIZOLATOR

FESTA®



17024	160 mm	6
-------	--------	---



VDE KOMBINÁLT FOGÓ  
VDE CLESTE COMBINAT

FESTA®

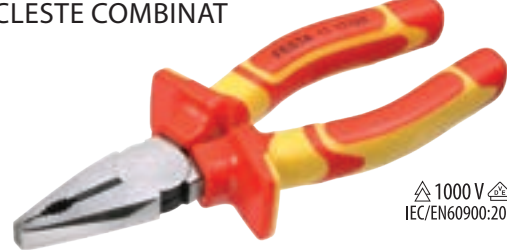

1000 V IEC/EN60900:2004

CrV

17125	160 mm	6
17126	180 mm	6
17127	200 mm	6



VDE OLDALCSÍPŐ FOGÓ  
VDE CLESTE SFIC

FESTA®



CrV

1000 V IEC/EN60900:2004

17128	160 mm	6
-------	--------	---



VDE HUZALVÁGÓ FOGÓ  
VDE CLESTE DE TAIAT CABLURI DE SARMA

FESTA®



CrV

1000 V IEC/EN60900:2004

17130	160 mm	6
-------	--------	---



TELEFON FOGÓ, EGYENES  
VDE CLESTE CU FALCI ASCUTITE LUNGI

FESTA®



CrV

1000 V IEC/EN60900:2004

17133	160 mm	6
-------	--------	---



TELEFON FOGÓ, HAJLÍTOTT  
VDE CLESTE CU FALCI ASCUTITE LUNGI

FESTA®



CrV

1000 V IEC/EN60900:2004

17135	160 mm	6
-------	--------	---



VDE SZEMES FOGÓ  
VDE CLESTE CU FALCI ROTUNDE LUNGI

FESTA®



CrV

1000 V  
IEC/EN60900:2004



17137 160 mm

6

VDE FOGÓ KÁBELCSUPASZÍTÓ  
VDE CLESTE DEZIZOLATOR

FESTA®



CrV

1000 V  
IEC/EN60900:2004



17138 160 mm

6

VÍZPUMPA FOGÓ  
CLESTE PENTRU INSTALATORI

FESTA®



CrV



17012 SIKO 250 mm króm /crom  
17060 SIKO 300 mm króm /crom

6

10

VÍZPUMPA FOGÓ  
CLESTE PENTRU INSTALATORI

FESTA®



CrV



17059 SIKO 180 mm  
17061 SIKO 250 mm  
17062 SIKO 300 mm  
17080 SIKO 400 mm

6

6

10

10

VÍZPUMPA FOGÓ  
CLESTE PENTRU INSTALATORI

FESTA®



CrV



17014 SIKO 250 mm

6

VÍZPUMPA FOGÓ  
CLESTE PENTRU INSTALATORI

FESTA®



CrV



17079 SIKO 250 mm

6

VÍZPUMPA FOGÓ  
CLESTE PENTRU INSTALATORI

FESTA®



CrV



17013 SIKO 250 mm

6

HARAPÓ FOGÓ  
CLESTE PENTRU CUIE

FESTA®



CrV



17300 160 mm  
17301 180 mm  
17302 200 mm

6

6

6

RABITZ FOGÓ  
CLESTE PENTRU SARMA

FESTA®



CrV



17304 275 mm  
17305 220 mm

6

6

HARAPÓ FOGÓ  
CLESTE PENTRU CUIE

FESTA®



CrV



17015 160 mm  
17016 180 mm  
17017 200 mm

6

6

6

**RABITZ FOGÓ  
CLESTE PENTRU SARMA**



**17019** 220 mm begumizott / cauciucat



**CSAPSZEGVÁGÓ, KÁBELVÁGÓVAL  
CLESTI PENTRU TAIAT  
FIER BETON**



**FESTA®**

CrV



<b>17055</b>	14" / 360 mm
<b>17056</b>	18" / 460 mm
<b>17057</b>	24" / 610 mm
<b>17058</b>	30" / 760 mm

20
12
8
5

**CSAPSZEGVÁGÓ  
CLESTI PENTRU TAIAT FIER BETON**

HRC 55-58

**FESTA®**



CrV



<b>17051</b>	14" / 360 mm
<b>17052</b>	18" / 460 mm
<b>17053</b>	24" / 610 mm
<b>17054</b>	30" / 760 mm
<b>17048</b>	36" / 910 mm

20
10
8
5
5

**CSAPSZEGVÁGÓ  
CLESTI PENTRU TAIAT FIER BETON**



<b>17028</b>	14" / 360 mm
<b>17020</b>	18" / 460 mm
<b>17021</b>	24" / 610 mm
<b>17022</b>	30" / 760 mm

20
20
10
5

**DRÓTVÁGÓ FOGÓ  
CLESTE DE TAIAT CABLURI DE SARMA**

acél vezeték / sarma din oțel  
ACRS kábelek / cabluri ACSR  
Repülőgépkábelek / cabluri pentru avion

húrok 5 mm-ig / sarma de oțel până la  $\varnothing$  5 mm  
huzal 6 mm-ig / sarma de oțel până la 6 mm

**FESTA®**



CrV



**17029** 200 mm

**BETONVASVÁGÓ  
CLESTI PENTRU FRANGHII**

**FESTA®**



CrV



**17039** 24" / 610 mm • max  $\varnothing$  16 mm

**TÖBBFUNKCIÓS FOGÓ  
FOARFECĂ PENTRU GARD**

**FESTA®**



CrV



**17109**

**DRÓTVÁGÓ  
MINI CLESTE TAIETOR**

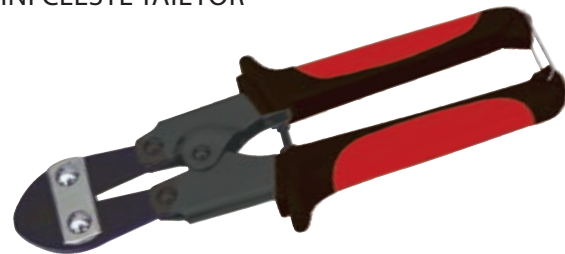

**17038** 8" / 210 mm • max  $\varnothing$  5 mm

**PATENTFOGÓ  
CLESTE MENGHINA**



**17035** beállítható / ajustabil

**PATENTFOGÓ  
CLESTE MENGHINA**



**17023**

▼ PATENTFOGÓ  
CLESTE MENGHINA



17036



▼ ZÉGER FOGÓ KLT.  
CLESTE PENTRU SIGURANTA SEGER



17025 klt / set



▼ ZÉGER FOGÓ  
CLESTE SIGURANTA ZEGER DREPT

FESTA®



17190

17191



17190 belső, egyenes / de interior 180 mm

17191 külső, egyenes / de exterior 180 mm

6

6

▼ ZÉGER FOGÓ  
CLESTE SIGURANTA ZEGER INDOIT

FESTA®



17192

17193



17192 belső, hajlított /indoit, de interior 180 mm

17193 külső, hajlított /indoit, de exterior 180 mm

6

6

▼ MINI FOGÓ KLT.  
SET CLESTI MINI

FESTA®



17040 klt / set 110 mm



▼ MINI KOMBINÁLT FOGÓ  
CLESTE COMBINAT MINI

FESTA®



17041 110 mm



▼ MINI OLDALCSÍPŐ FOGÓ  
CLESTE SFIC MINI

FESTA®



17042 110 mm



▼ MINI HOMLOKCSÍPŐ FOGÓ  
CLESTE MINI

FESTA®



17043 100 mm



▼ MINI LAPOSCSÖRŰ FOGÓ  
CLESTE CU FALCI ASCUTITE LUNGI

FESTA®



17044 120 mm



▼ MINI SZEMES FOGÓ  
CLESTE MINI ROTIRE

FESTA®



17045 120 mm





DARABOLÓ OLLÓ, PROFILOKHOZ  
FOARFECA PENTRU PROFILE

FESTA®



lecek, csövek, profilok  
plinte, profile, tevi

17050



CSŐFOGÓ, SZABÁLYZÓ ANYÁVAL  
CLESTE REGLABIL

FESTA®



CrV



17063 10,5" / 270 mm  
17064 12" / 300 mm

6  
6

CSŐFOGÓ, SZABÁLYZÓ ANYÁVAL  
CLESTE REGLABIL



17065 260 mm  
17066 300 mm



6  
6

CSŐFOGÓ, SZABÁLYZÓ ANYÁVAL 45°, S  
CLESTE REGLABIL 45°, S

FESTA®



CrV



17067 1" / 330 mm  
17068 1,5" / 420 mm  
17069 2" / 540 mm

20  
20  
10

CSŐFOGÓ, SZABÁLYZÓ ANYÁVAL 90°  
CHEIE REGLABILA 90°

FESTA®



CrV



17070 2,5" / 355 mm  
17071 3" / 455 mm  
17072 3,5" / 610 mm

24  
6  
8

CSŐFOGÓ, SZABÁLYZÓ ANYÁVAL 90°  
CLESTE REGLABIL 90°

FESTA®



CrV



17075 1" / 330 mm  
17076 1,5" / 420 mm  
17077 2" / 540 mm

1  
1  
1

BÁDOGOS FOGÓ EGYENES  
CLESTE TINICHIGIU DREPT

FESTA®



17090 50 x 280 mm



1

BÁDOGOS FOGÓ 45° FOKBAN HAJLÍTOTT  
CLESTE TINICHIGIU 45°

FESTA®



17091 50 x 280 mm



1

BÁDOGOS FOGÓ 90° FOKBAN HAJLÍTOTT  
CLESTE TINICHIGIU 90°

FESTA®



17092 50 x 280 mm



1

LEMEZVÁGÓ OLLÓ  
FOARFECA PENTRU TABLA  
HRC 58-62

FESTA®



55-58 HRC

CrV



17112 egyenes / drept  
17117 jobbos / dreapta  
17122 balos / stanga

10  
10  
10

LEMEZVÁGÓ OLLÓ  
FOARFECA PENTRU TABLA



CrV

17111	egyenes / drept	10
17116	jobbos / dreapta	10
17121	balos / stanga	10



LEMEZVÁGÓ OLLÓ  
FOARFECA PENTRU TABLA  
HRC 58-62



CrV

17150	balos / stanga	40/260 mm	6
17151	jobbos / dreapta	40/260 mm	6
17152	egyenes / drept	45/250 mm	6

LEMEZVÁGÓ OLLÓ  
FOARFECA PENTRU TABLA



CrV

17170 250 mm

LEMEZVÁGÓ OLLÓ  
FOARFECA PENTRU TABLA



CrV

17155 70/265 mm

LEMEZVÁGÓ OLLÓ  
FOARFECA PENTRU TABLA



CrV

17156 60/245 mm

LEMEZVÁGÓ OLLÓ  
FOARFECA PENTRU TABLA



CrV

17165 60/250 mm

KAROS LEMEZVÁGÓ  
GHILOTINA MANUALA

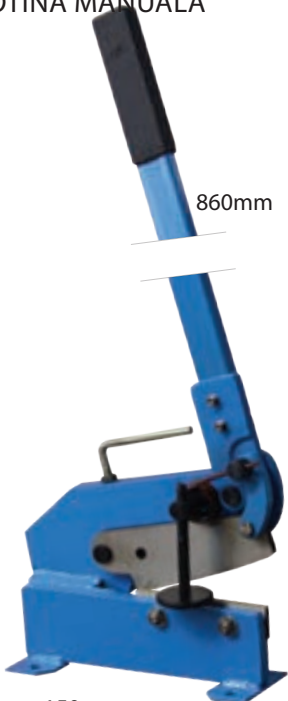

	17175	17177
	max 4mm	5mm
	max Ø10mm	Ø12mm
	max 8x8mm	10x10mm

17175	150mm	5
17177	250mm	2

LEMEZVÁGÓ OLLÓ  
FOARFECA PENTRU TABLA



CrV

17167 75/300 mm

LEMEZVÁGÓ OLLÓ  
FOARFECA PENTRU TABLA



CrV

17169 35/250 mm

MŰSZAKI OLLÓ  
FOARFECA CABLURI

FESTA®



INOX



17158 50/150 mm

6

MŰSZAKI OLLÓ  
FOARFECA

FESTA®



textil, kůže, karton, papír, plasty, guma  
material textil, carton, hartie, plastic, cauciuc



16420 200 mm

6

MŰSZAKI OLLÓ  
FOARFECA



INOX



17159 65/220 mm

6

MŰSZAKI OLLÓ  
FOARFECA BUCATARIE



INOX



17160 70/210 mm

6

OLLÓ  
FOARFECA



INOX



16401	3 db/buc	12
16405	13 cm	24
16406	16 cm	24
16407	17 cm	24
16408	22 cm	12

12

24

24

24

12

AUTOMATA KÁBELCSUPASZÍTÓ FOGÓ  
CLESTE AUTOMAT PENTRU DEZIZOLARE CABLURI



17180 Ø 0,75-2,5 mm

12

LEMEZVÁGÓ ADAPTER  
ADAPTOR PENTRU TAIAT TABLA

max. tloušťka plechu / grosime max tabla  
1,8 mm - ocel / otel  
1,2 mm - nerez / inox  
2 mm - plasty, hliník, měď / plastic, ALU, cupru

meghajtás fúróval / burghiu de ghidaj



Ø 4 mm



20363

5

BLANKOLÓ FOGÓ  
CLESTE DE DEZIZOLAT SI TAIAT



17181 Ø 0,6-2,6 mm

12

LYUKASZTÓ FOGÓ  
CLESTE DE PERFORAT



17185 Ø 2; 2,5; 3; 3,5; 4; 4,5 mm

10

# FESTA®

## magas minőségű dugókulcsok 10 éves garancia

CrV anyagok, kovácsolt  
legmagasabb minőségű anyagok és megmunkálás  
minden fej és alkatrész kovácsolással van elkészítve  
erős fém és műanyag tartódobozok

## seturi de chei CrV, de inalta calitate garantie pe 10 ani

materiale CrV forjate  
cea mai inalta calitate a materialelor si procesarii  
toate capetele si piesele facute prin forjare  
metal si plastic rezistent

### DUGÓKULCS KLT. SET CHEI TUBULARE



17210 13 db/buc 1/2"

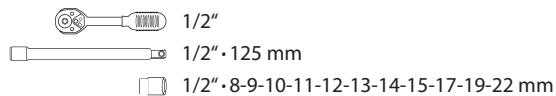

FESTA®



made by  
HINTON

CrV



### DUGÓKULCS KLT. SET CHEI TUBULARE



17211 17 db/buc 1/4"

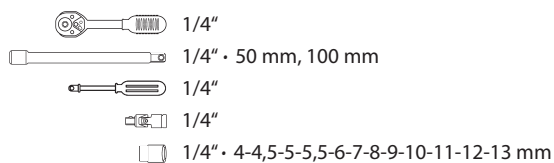

FESTA®



made by  
HINTON

CrV



### DUGÓKULCS KLT. SET CHEI TUBULARE



17212 25 db/buc 1/2"

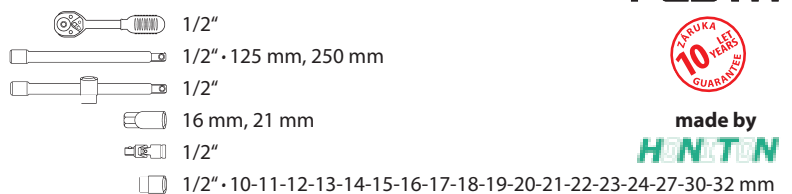

FESTA®



made by  
HINTON

CrV



### DUGÓKULCS KLT. SET CHEI TUBULARE



17214 59 db/buc 1/4" + 1/2"

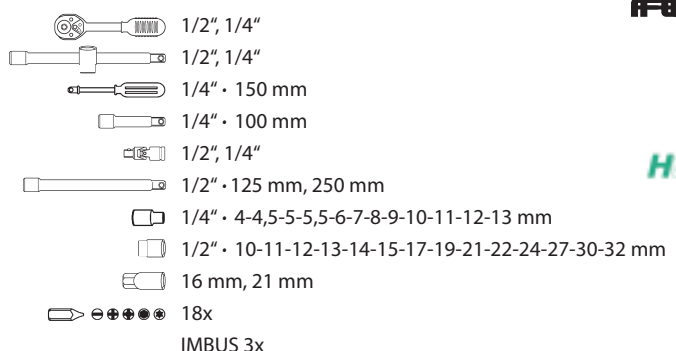

FESTA®



made by  
HINTON







CrV



DUGÓKULCS KLT.  
SET CHEI TUBULARE



17213 28 db/buc 1/2"

-  1/2"
-  1/2" • 125 mm, 250 mm
-  1/2"
-  16 mm, 21 mm
-  1/2"
-  1/2"
-  1/2" • 8-9-10-11-12-13-14-15-16-17-18-19-20-21-22-23-24-27-30-32 mm

FESTA®



HNTON



CrV



DUGÓKULCS KLT.  
SET CHEI TUBULARE

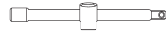
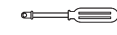

17215 16 db/buc 1/4"

-  1/4"
-  1/4" • 50 mm
-  1/4"
-  1/4"
-  1/4" • 4-4,5-5-5,5-6-7-8-9-10-11-12-13 mm

FESTA®



HNTON







CrV



DUGÓKULCS KLT.  
SET CHEI TUBULARE



17216 25 db/buc 1/2"

-  1/2"
-  1/2" • 125 mm, 250 mm
-  1/2"
-  16 mm, 21 mm
-  1/2"
-  1/2" • 10-11-12-13-14-15-16-17-18-19-20-21-22-23-24-27-30-32 mm

FESTA®



HNTON







CrV

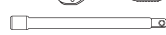
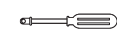

DUGÓKULCS KLT.  
SET CHEI TUBULARE



17217 32 db/buc 1/4"

-  1/4"
-  1/4" • 50 mm
-  1/4"
-  1/4"
-  1/4"
-  1/4" • 4-4,5-5-5,5-6-7-8-9-10-11-12-13 mm
-  12x
-  IMBUS 3x

FESTA®



HNTON











CrV

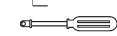

DUGÓKULCS KLT.  
SET CHEI TUBULARE



17218 56 db/buc 1/4" + 1/2"

-  1/2", 1/4"
-  1/2", 1/4"
-  1/4" 150 mm
-  1/4" 100 mm
-  1/2", 1/4"
-  1/2" • 125 mm, 250 mm
-  1/4" • 4-4,5-5-5,5-6-7-8-9-10-11-12-13 mm
-  1/2" • 10-11-12-13-14-15-17-19-21-22-24-27-30-32 mm
-  16 mm, 21 mm
-  16x
-  IMBUS 3x

FESTA®



HNTON

CrV



DUGÓKULCS KLT.  
SET CHEI TUBULARE



- 1/2", 1/4"
- 1/2", 1/4"
- 1/4"
- 1/4" · 50 mm, 100 mm
- 1/2", 1/4"
- 1/2", 1/4"
- 1/2" 125 mm, 250 mm
- 1/4" · 4-4,5-5-5,5-6-7-8-  
-9-10-11-12-13-14 mm
- 1/2" · 10-11-12-13-14-15-17-  
-19-21-22-24-27-30-32 mm
- 1/4" · 6-7-8-9-10-11-12-13 mm
- 1/2" · 14-15-17-19-22 mm
- 16 mm, 21 mm
- 34x
- IMBUS 3x

FESTA®



made by

HNTN

CrV  
CrV

3

17219 94 db/buc 1/4" + 1/2"

DUGÓKULCS KLT.  
SET CHEI TUBULARE



- 1/2"
- 1/2" · 125 mm, 250 mm
- 1/2"
- 16 mm, 21 mm
- 1/2"
- 1/2" · 8-9-10-11-12-13-14-15-16-17-  
-18-19-20-21-22-23-24-27-30-32 mm

FESTA®



made by

HNTN

CrV



4

17225 27 db/buc 1/2"

DUGÓKULCS KLT.  
SET CHEI TUBULARE



- 3/4"
- 3/4" · 100 mm, 200 mm
- 3/4" · 460 mm
- 3/4" · 22-24-27-30-32-36-38-41-46-50 mm

FESTA®



made by

HNTN

CrV



1

17226 14 db/buc 3/4"

DUGÓKULCS KLT.  
SET CHEI TUBULARE



- 3/4"
- 3/4" · 100 mm, 200 mm, 400 mm
- 3/4" · 460 mm
- 3/4" · 19-21-22-23-24-26-27-29-  
-30-32-35-36-38-41-46-50 mm

FESTA®



made by

HNTN

CrV



1

17227 21 db/buc 3/4"

DUGÓKULCS FEJ  
CAPETE CHEI TUBULARE



FESTA®



made by

HNTN

CrV

- 1/2" HEX · 4-5-6-7-8-  
-10-12-14-17 mm



20

17345 1/2" HEX IMBUS

DUGÓKULCS FEJ  
CAPETE CHEI TUBULARE



FESTA®



made by

HNTN

Cr-Mo

- 1/2" · 17-19-21 mm



20

17335 1/2" - 3 db/buc

DUGÓKULCS FEJ  
CAPETE CHEI TUBULARE



**FESTA**



made by  
**HNTN**

CrV

1/2" TORX • T20-T25-  
T27-T30-T40-T45-  
T50-T55-T60 mm



17346 1/2" TORX

20

DRIVELOCK DUGÓKULCS FEJ  
SET CHEI TUBULARE DRIVELOCK

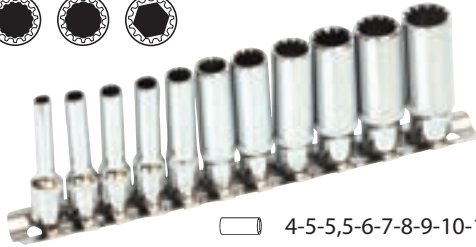

CrV

4-5-5,5-6-7-8-9-10-11-12-13 mm



17250 1/4", 12 db/buc

10

CrV RACSNIS HAJTÓKAR  
CLICHET REVERSIBIL CrV

**FESTA**



made by  
**HNTN**

CrV



17220 1/4" /36 fogú/zimti  
17222 3/8" /36 fogú/zimti  
17224 1/2" /36 fogú/zimti  
17208 1/2" /72 fogú/zimti

20  
10  
6  
6

TORX DUGÓKULCS FEJ  
SET CHEI TUBULARE TORX



CrV

1/4" • 5-6-7-8-10  
1/2" • 12-14-16-18



17255 9 db/buc • TORX

10

DUGÓKULCS KLT.  
SET CHEI TUBULARE



1/2" • 72T  
1/2" • 125 mm  
1/2" • 10-11-12-13-14-15-17-19-22-24 mm

CrV



17229 12 db/buc 1/2"

10

DUGÓKULCS KLT.  
SET CHEI TUBULARE



1/2" • 72T  
1/2" • 75, 125 mm  
1/2"  
1/2" • 10-11-12-13-14-15-16-17-18-19-22-24 mm  
1/2" • 17mm, 19mm  
3 way adaptor  
16mm, 21mm

CrV



17230 21 db/buc 1/2"

5

DUGÓKULCS KLT.  
SET CHEI TUBULARE



1/4" • 72T"  
1/4" • 50 mm, 100 mm  
1/4"  
1/4" • 4-5-5,5-6-7-8-10-11-12-13 mm  
2x ADAPTER  
1/4" • 6-7-8-10-12-13 mm  
11x  
IMBUS 3x

CrV



17231 36 db/buc 1/4"

10

DUGÓKULCS KLT.  
SET CHEI TUBULARE



- 1/4" · 72T
- 1/4" · 50 mm, 100 mm
- 1/4"
- 1/4"
- 1/4"
- 1/4"
- 1/4"
- 1/4" · 4-4,5-5-5,5-6-7-8-9-10-11-12-13-14 mm
- 22x
- IMBUS 3x

17233 45 db/buc 1/4"



DUGÓKULCS KLT.  
SET CHEI TUBULARE



- 1/2", 1/4" · 72T
- 150 mm
- 1/4" · 75 mm
- 1/2"
- 2x ADAPTER
- 1/2" · 125, 250 mm
- 1/2" · 10-11-12-13-14-15-16-17-18-19-20-21-22-23-24-27 mm
- 1/4" · 4-5-5,5-6-7-8-10-11-12-13 mm
- 1/2" · 21 mm
- 33x

17234 72 db/buc 1/4" + 1/2"



DUGÓKULCS KLT.  
SET CHEI TUBULARE



- 1/2", 1/4" · 72T
- 1/4"
- 150 mm
- 1/4" · 50 mm, 100 mm
- 1/2", 1/4"
- 1/2", 1/4"
- 1/2" · 125 mm, 250 mm
- 1/4"
- 1/4" · 4-4,5-5-5,5-6-7-8-9-10-11-12-13-14 mm
- 1/2" · 10-11-12-13-14-15-16-17-18-19-20-21-22-23-24-27-30-32 mm
- 1/4" · 6-7-8-9-10-11-12-13 mm
- 1/2" · 14-15-17-19 mm
- 16 mm, 21 mm
- 33x
- IMBUS 3x

17235 94 db/buc 1/4" + 1/2"



DUGÓKULCS KLT.  
SET CHEI TUBULARE



- 1/2", 1/4" · 72T
- 1/4"
- 150 mm
- 1/4" · 50 mm, 100 mm
- 1/2", 1/4"
- 1/2"
- 1/2" · 125 mm, 250 mm
- E · 10-11-12-14-16-18-20-24
- E · E4-E5-E6-E7-E8
- 1/4" · 4-4,5-5-5,5-6-7-8-9-10-11-12-13-14 mm
- 1/2" · 10-11-12-13-14-15-16-17-18-19-20-21-22-24-27-30-32 mm
- 1/4" · 6-7-8-9-10-11-12-13 mm
- 1/2" · 14-15-17-19-22 mm
- 1/4" · 4-5,5-6,5
- 3-4-5-6
- 1-2
- 8-10-15-20-25-27-30
- 16 mm, 21 mm
- 17x
- IMBUS 3x

17236 108 db/buc 1/4" + 1/2"





**DUGÓKULCS KLT. (INCH)**  
**SET CHEI TUBULARE (INCH)**



- 1/2", 1/4"
- 1/4"
- 150 mm
- 1/4" · 50 mm, 100 mm
- 1/2", 1/4"
- 1/2"(M) x 3/8"(F)
- 1/2" · 125 mm, 250 mm
- E · 10-11-12-14-16-18-20-24
- E · E4-E5-E6-E7-E8
- 1/4" · 5/32"-3/16"-7/32"-1/4"-9/32"-5/16"-11/32"-3/8"-13/32"-7/16"-15/32"-1/2"-9/16"
- 1/2" · 5/16"-3/8"-7/16"-15/32"-1/2"-9/16"-9/32"-5/8"-11/16"-23/32"-3/4"-13/16"-7/8"-15/16"-1 1/16"-1 3/16"-1 1/4"
- 1/4" · 1/4"-9/32"-5/16"-11/32"-3/8"-7/16"-15/32"-1/2"
- 1/2" · 9/16"-5/8"-11/16"-3/4"-7/8"
- 1/4" · ⊕ 4-5-5-6.5
- ⊕ 3-4-5-6
- ⊕ 1-2
- ⊕ 8-10-15-20-25-27-30
- 16 mm, 21 mm
- ⊕ ⊕ ⊕ ⊕ ⊕ 17x
- IMBUS 3x

CrV  
 3

17239 108 db/buc 1/4" + 1/2"

**DUGÓKULCS KLT.**  
**SET CHEI TUBULARE**



- 1/2", 1/4", 3/8"
- 1/4"
- 1/4" · 150 mm
- 1/4" · 50 mm, 100 mm
- 1/2" · 125 mm, 250 mm
- 3/8" · 150 mm
- 1/2", 1/4", 3/8"
- 1/2"SQ x 5/16"HEX
- 3/8"SQ x 5/16"HEX
- 1/2"(M) x 3/8"(F)
- 1/4" · E4-E5-E6-E7-E8
- 3/8" · E10-E12-E14-E16-E18-E20
- 1/2" · E18-E24
- 1/4" · 4-4,5-5-5,5-6-7-8-9-10-11-12-13-14 mm
- 3/8" · 10-11-12-13-14-15-16-17-18-19 mm
- 1/2" · 9-10-11-12-13-14-15-16-17-18-19-21-22-24-27-30-32 mm
- 1/4" · 5-6-7-8-10-11-12 mm
- 3/8" · 10-11-12-13-14-15 mm
- 1/2" · 14-17 mm
- 1/2" · 17-19-21 mm (Cr-Mo)
- 1/2" · 16-18-21 mm
- 8-9-10-11-12-13-14-15-16-17-19-22 mm
- 1/4" · ⊕ S 4-5-5-7 mm
- 1/4" · ⊕ PH 1-2-3
- 1/4" · ⊕ PZ 1-2-3
- 1/4" · ⊕ H 3-4-5-6-7-8
- 1/4" · ⊕ HTa 3-4-5-6-7-8
- 1/4" · ⊕ T 10-15-20-25-30-40
- 1/4" · ⊕ TTa 10-15-20-25-30-40
- 5/16" · ⊕ S 8-10 mm
- 5/16" · ⊕ PH 3-4
- 5/16" · ⊕ PZ 3-4
- 5/16" · ⊕ H 7-8-10-12-14
- 5/16" · ⊕ T 30-40-45-50-55-60
- 5/16" · ⊕ TTa 30-40-45-50-55-60
- HEX ⊕ H 1,5-2-2,5-3-4-5-6-8-10
- TORX ⊕ T 10-15-20-25-27-30-40-45-50

CrV  
 2

17237 176 db/buc 1/4" + 1/2" + 3/8"

**DUGÓKULCS KLT.**  
**SET CHEI TUBULARE**



- 1/2" · 72T
- 1/2" · 125 mm
- 1/2" · 10-11-12-13-14-15-17-19-22-24 mm

CrV  
 5

17245 12 db/buc · 1/2"

RACSNISSZÁR, HAJLÍTOTT, CRV  
CLICHET CURBAT Crv

FESTA®



CrV



17294	1/4" · 36 fogú/zimti	50
17295	3/8" · 36 fogú/zimti	25
17296	1/2" · 36 fogú/zimti	5

RACSNISSZÁR, HAJLÍTOTT, CRV  
CLICHET CURBAT Crv

FESTA®



CrV



17297	1/4" · 72 fogú/zimti	10
17298	3/8" · 72 fogú/zimti	25
17299	1/2" · 72 fogú/zimti	10

CrV RACSNIS HAJTÓKAR  
CLICHET REVERSIBIL CrV

FESTA®



CrV



17240	1/4" · 72 fogú/zimti	10
17241	3/8" · 72 fogú/zimti	10
17242	1/2" · 72 fogú/zimti	10

RACSNIS HAJTÓKAR, ÜVEGSZÁLAS  
CLICHET REVERSIBIL

HOBBY



17243	1/4" · 36 fogú/zimti	6
17244	1/2" · 36 fogú/zimti	6

RACSNIS HAJTÓKAR 1/4"  
CLICHET REVERSIBIL 1/4"

FESTA®



CrV



17292	1/4" · 72 fogú/zimti	40
-------	----------------------	----

DUGÓKULCS FEJ 1/4"  
CHEI TUBULARE 1/4"

FESTA®



CrV



17820	4 mm	10	17827	9 mm	10
17821	4,5 mm	10	17828	10 mm	10
17822	5 mm	10	17829	11 mm	10
17823	5,5 mm	10	17830	12 mm	10
17824	6 mm	10	17831	13 mm	10
17825	7 mm	10	17832	14 mm	10
17826	8 mm	10			

DUGÓKULCS FEJ 1/2"  
CHEI TUBULARE 1/2"

FESTA®



CrV



17308	8 mm	10
17309	9 mm	10
17310	10 mm	10
17311	11 mm	10
17312	12 mm	10
17313	13 mm	10
17314	14 mm	10
17315	15 mm	10
17316	16 mm	10
17317	17 mm	10
17318	18 mm	10
17319	19 mm	10
17320	20 mm	10
17322	22 mm	10
17324	24 mm	10
17327	27 mm	20
17330	30 mm	25
17332	32 mm	20
17333	34 mm	20
17334	36 mm	20

DUGÓKULCS FEJ 3/4"  
CHEI TUBULARE 3/4"

FESTA®



CrV



17835	17 mm	10
17836	18 mm	10
17837	19 mm	10
17838	21 mm	10
17839	22 mm	10
17840	24 mm	10
17841	26 mm	10
17842	27 mm	10
17843	28 mm	10
17844	30 mm	10
17845	32 mm	10
17846	33 mm	10
17847	36 mm	10
17848	38 mm	10
17849	41 mm	10
17850	46 mm	10
17851	50 mm	10
17852	55 mm	10
17853	60 mm	10
17854	65 mm	10
17855	70 mm	10
17856	75 mm	10

DUGÓKULCS FEJ 1/4"  
CHEI TUBULARE 1/4"



FESTA®

CrV



17860	4 mm	10	17866	10 mm	10
17861	5 mm	10	17867	11 mm	10
17862	6 mm	10	17868	12 mm	10
17863	7 mm	10	17869	13 mm	10
17864	8 mm	10	17870	14 mm	10
17865	9 mm	10			

DUGÓKULCS FEJ 1/2"  
CHEI TUBULARE 1/2"



FESTA®

CrV



17871	10 mm	10
17872	11 mm	10
17873	12 mm	10
17874	13 mm	10
17875	14 mm	10
17876	15 mm	10
17877	16 mm	10
17878	17 mm	10
17879	18 mm	10
17880	19 mm	10
17881	20 mm	10
17882	21 mm	10
17883	22 mm	10
17884	23 mm	10
17885	24 mm	10
17886	25 mm	10
17887	26 mm	10
17888	27 mm	10
17889	28 mm	10
17890	30 mm	10
17891	32 mm	10
17892	34 mm	10

DUGÓKULCS FEJ TORX 1/4"  
CHEI TUBULARE TORX 1/4"



FESTA®

CrV



17930	E4	10
17931	E5	10
17932	E6	10
17933	E7	10
17934	E8	10
17935	E10	10

DUGÓKULCS FEJ 1/2"  
CHEI TUBULARE TORX 1/2"



FESTA®

CrV



17936	E10	10
17937	E11	10
17938	E12	10
17939	E14	10
17940	E16	10
17941	E18	10
17942	E20	10
17943	E22	10
17944	E24	10

DUGÓKULCS FEJ MULTILOCK 1/4" - 25 mm  
CHEI TUBULARE MULTILOCK 1/4" - 25 mm



FESTA®

CrV



17895	4 mm · 25 mm	10	17902	9 mm · 25 mm	10
17896	4,5 mm · 25 mm	10	17903	10 mm · 25 mm	10
17897	5 mm · 25 mm	10	17904	11 mm · 25 mm	10
17898	5,5 mm · 25 mm	10	17905	12 mm · 25 mm	10
17899	6 mm · 25 mm	10	17906	13 mm · 25 mm	10
17900	7 mm · 25 mm	10	17907	14 mm · 25 mm	10
17901	8 mm · 25 mm	10			

CSAVARHÚZÓ FEJ, 1/4", PH  
BIT INCASTRAT PHILIPS 1/4"



FESTA®

CrV



18925	PH 1	10
18926	PH 2	10
18927	PH 3	10

CSAVARHÚZÓ FEJ, 1/4", PZ  
BIT INCASTRAT POZIDRIVE 1/4"



FESTA®

CrV



18928	PZ 0	10
18929	PZ 1	10
18930	PZ 2	10
18931	PZ 3	10

DUGÓKULCS FEJ MULTILOCK 1/2"  
CHEI TUBULARE MULTILOCK 1/2"



FESTA®

CrV



17910	8 mm · 38 mm	10
17911	9 mm · 38 mm	10
17912	10 mm · 38 mm	10
17913	11 mm · 38 mm	10
17914	12 mm · 38 mm	10
17915	13 mm · 38 mm	10
17916	14 mm · 38 mm	10
17917	15 mm · 38 mm	10
17918	16 mm · 38 mm	10
17919	17 mm · 38 mm	10
17920	18 mm · 38 mm	10
17921	19 mm · 38 mm	10
17922	21 mm · 38 mm	10
17923	22 mm · 38 mm	10
17924	24 mm · 38 mm	10
17925	27 mm · 38 mm	10
17926	30 mm · 44 mm	10
17927	32 mm · 44 mm	10

CSAVARHÚZÓ FEJ, 1/4", LAPOS  
BIT INCASTRAT 1/4"



FESTA®

CrV

18920	4 mm	10
18921	5,5 mm	10
18922	7 mm	10



CSAVARHÚZÓ FEJ, 1/4", IMBUSZ  
BIT INCASTRAT IMBUS 1/4"



FESTA®

CrV

18932	2 mm	10
18933	2,5 mm	10
18934	3 mm	10
18935	4 mm	10
18936	5 mm	10
18937	6 mm	10
18938	7 mm	10
18939	8 mm	10



CSAVARHÚZÓ FEJ, 1/4", TORX  
BIT INCASTRAT TORX 1/4"



FESTA®

CrV

18947	T 4	10
18948	T 5	10
18949	T 6	10
18950	T 8	10
18951	T 10	10
18952	T 12	10
18953	T 14	10



CSAVARHÚZÓ FEJ, 1/2", IMBUSZ  
BIT INCASTRAT IMBUS 1/2"



FESTA®

CrV

18940	6 mm	10
18941	7 mm	10
18942	8 mm	10
18943	10 mm	10
18944	12 mm	10
18945	14 mm	10
18946	17 mm	10



CSAVARHÚZÓ FEJ, 1/4", XZN  
BIT INCASTRAT XZN 1/4"



FESTA®

CrV

18966	M 6	10
18967	M 8	10
18968	M 10	10
18969	M 12	10



CSAVARHÚZÓ FEJ, 1/2", TORX  
BIT INCASTRAT TORX 1/2"



FESTA®

CrV

18954	T 10	10
18955	T 15	10
18956	T 20	10
18957	T 25	10
18958	T 27	10
18959	T 30	10

18960	T 40	10
18961	T 45	10
18962	T 50	10
18963	T 55	10
18964	T 60	10
18965	T 70	10



KARDÁN CSUKLÓ  
CUPLA CARDANICA

FESTA®



CrV

17405	1/4" · 39mm	10
17406	1/2" · 71mm	10
17407	3/4" · 105mm	10



ADAPTER  
ADAPTOR

FESTA®



CrV

17410	A - 1/4" / B - 3/8"	10
17411	A - 3/8" / B - 1/4"	10
17412	A - 3/8" / B - 1/2"	10
17413	A - 1/2" / B - 3/8"	10
17414	A - 1/2" / B - 3/4"	10
17415	A - 3/4" / B - 1/2"	10
17416	A - 1/4" / B - 1/2"	10



BIT ADAPTER RACSNIRA 1/4"  
BIT / ADAPTOR CLICHET-BITURI 1/4"

Stahlberg

1/4" ↔ 1/4"



CrV

18619	5db/buc	1
-------	---------	---



FÚRÓ ADAPTER KÉSZLET  
SET ADAPTORI



CrV

18604	1/4", 3/8", 1/2"	10
-------	------------------	----



HAJTÓKAR ADAPTER  
CURSOR

FESTA®



CrV



17420	1/4"	1
17421	1/2"	1
17422	3/4"	1

T KULCS  
EXTENSIE T LUNGA CU CUPLA

FESTA®



CrV



17401	1/4" · 250mm	1
17402	1/2" · 400mm	1

KURBLIS HAJTÓKAR  
COARBA

FESTA®



CrV



17425	1/2" · 400 mm	1
-------	---------------	---

HOSSZABBÍTÓ SZÁR  
PRELUNGITOR

FESTA®



CrV



17390	1/4" · 50mm	1
17391	1/4" · 100mm	1
17392	1/4" · 150mm	1
17393	1/2" · 75mm	1
17394	1/2" · 125mm	1
17395	1/2" · 250mm	1
17396	3/4" · 100mm	1
17397	3/4" · 200mm	1
17398	3/4" · 400mm	1

RADIÁTORKULCS  
CHEIE IMBUS UNIVERSALA

FESTA®

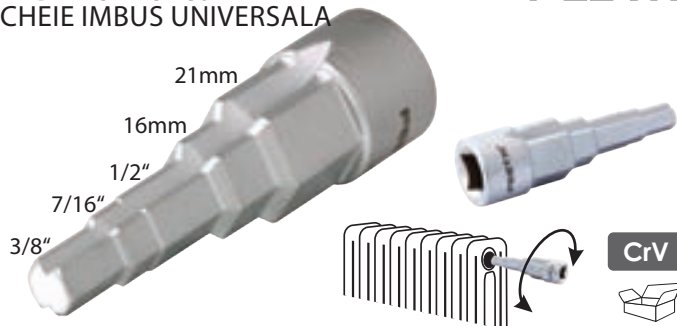

CrV



17455	1/2"	10
-------	------	----

T" HAJTÓKAR  
MANER T CU CURSOR

FESTA®



CrV



17382	1/4" · 115mm	1
17383	3/8" · 190mm	1
17384	1/2" · 250mm	1
17385	3/4" · 460mm	1
17386	1" · 640mm	1

HAJTÓKAR, CSUKLÓS  
MANER CU CUPLA

FESTA®



CrV



17380	1/2" · 350 mm	1
17381	3/4" · 500 mm	1

HAJTÓKAR 90°-OS  
MANER INDOIT

FESTA®



CrV



17427	1/2" · 60 x 320 mm	1
-------	--------------------	---

RUGÓS HOSSZABBÍTÓ  
PRELUNGITOR FLEXIBIL

FESTA®



CrV



17400	1/4" · 150mm	1
-------	--------------	---

RACSNIS HAJTÓKAR  
INELARA CU CLICHET

FESTA®



17450	19 mm	1
17451	18 mm	1

**FESTA®**

magas minőségű kulcsok CrV acélból  
minden kulcs kovácsolt és krómozott

chei de otel CrV de inalta calitate  
toate cheile sunt facute prin forjare; cromate

DIN 3110

DIN 3113

DIN 838

DIN 895

VILLÁSKULCS CrV  
CHEI FIXE CrV

**FESTA®**

CrV

DIN 3110



17550	6x7 mm	10
17551	8x9 mm	10
17552	8x10 mm	10
17553	10x11 mm	10
17590	10x13 mm	10
17554	12x13 mm	10
17555	14x15 mm	10
17556	13x16 mm	10
17557	13x17 mm	10
17591	14x17 mm	10
17558	16x17 mm	10
17559	17x19 mm	10
17560	18x19 mm	10
17592	19x22 mm	10
17593	19x24 mm	10
17561	20x22 mm	10
17569	21x23 mm	10
17562	24x27 mm	10
17563	30x32 mm	10
17564	30x34 mm	10
17565	32x36 mm	10
17566	36x41 mm	10
17567	46x50 mm	10
17568	55x60 mm	3

CSILLAG - VILLÁSKULCS CrV  
CHEI COMBIMATE CrV

**FESTA®**

CrV

DIN 3113



17570	7 mm	10
17571	8 mm	10
17572	9 mm	10
17573	10 mm	10
17574	11 mm	10
17575	12 mm	10
17576	13 mm	10
17577	14 mm	10
17578	15 mm	10
17579	16 mm	10
17580	17 mm	10
17581	18 mm	10
17582	19 mm	10
17583	22 mm	10
17584	24 mm	10
17585	27 mm	10
17586	30 mm	10
17587	32 mm	10
17589	36 mm	10

VILLÁSKULCS CrV  
CHEI FIXE CrV

**FESTA®**

DIN 3110

CrV



17756	6x7mm	10	17764	16x17mm	10
17757	8x9mm	10	17765	17x19mm	10
17758	8x10mm	10	17766	18x19mm	10
17759	10x11mm	10	17767	19x22mm	10
17760	12x13mm	10	17769	20x22mm	10
17762	13x16mm	10	17770	24x27mm	10
17763	13x17mm	10	17771	30x32mm	10
17761	14x15mm	10			

CSILLAG - VILLÁSKULCS CrV  
CHEI COMBIMATE CrV

**FESTA®**

DIN 3113

CrV



17780	6mm	10	17795	21mm	10
17781	7mm	10	17796	22mm	10
17782	8mm	10	17797	23mm	10
17783	9mm	10	17798	24mm	10
17784	10mm	10	17799	25mm	10
17785	11mm	10	17800	26mm	10
17786	12mm	10	17801	27mm	10
17787	13mm	10	17802	28mm	10
17788	14mm	10	17803	29mm	10
17789	15mm	10	17804	30mm	10
17790	16mm	10	17805	32mm	10
17791	17mm	10	17806	33mm	10
17792	18mm	10	17807	34mm	10
17793	19mm	10	17808	36mm	10
17794	20mm	10			

CSILLAGKULCS HAJLÍTOTT  
CHEI INELARE COTITE

**FESTA®**

CrV

DIN 838



17605	6x7 mm	10	17610	14x15 mm	10
17606	8x9 mm	10	17613	16x17 mm	10
17607	8x10 mm	10	17614	18x19 mm	10
17608	10x11 mm	10	17615	20x22 mm	10
17609	12x13 mm	10	17616	24x27 mm	10
17611	13x16 mm	10	17617	30x32 mm	10
17612	13x17 mm	10			

**RACSNIS KULCS, CSUKLÓS  
CHEIE COMBINATA CU ARTICULATIE**

**FESTA®**



CrV

72 fogú/zimti

17628	8 mm	5	17625	17 mm	5
17622	10 mm	5	17631	18 mm	5
17623	13 mm	5	17626	19 mm	5
17624	14 mm	5	17632	21 mm	5
17629	15 mm	5	17633	22 mm	5

**RACSNIS KULCS  
CHEIE COMBINATA CU CLICHET**

**FESTA®**



CrV

72 fogú/zimti

17660	6 mm	5	17668	15 mm	5
17661	8 mm	5	17669	16 mm	5
17662	9 mm	5	17670	17 mm	5
17663	10 mm	5	17671	18 mm	5
17664	11 mm	5	17672	19 mm	5
17665	12 mm	5	17674	21 mm	5
17666	13 mm	5	17675	22 mm	5
17667	14 mm	5			

**UNIVERZÁLIS KULCS  
CHEIE FIXA**

**FESTA®**



CrV

17680	19-51mm, 165mm	10
17681	32-76mm, 216mm	10
17682	51-121mm, 267mm	10
17683	114-159mm, 308mm	10

**VILLÁSKULCS  
CHEIE FIXE**



17460	6x7 mm	25
17461	8x9 mm	25
17462	8x10 mm	25
17463	10x11 mm	25
17481	10x13 mm	25
17464	12x13 mm	25
17465	14x15 mm	25
17466	13x16 mm	25
17467	13x17 mm	25
17482	14x17 mm	25
17468	16x17 mm	25
17469	17x19 mm	25
17470	18x19 mm	20
17483	19x22 mm	20
17484	19x24 mm	20
17471	20x22 mm	20
17472	24x27 mm	20
17473	30x32 mm	10
17485	36x41 mm	10

**CSŐKULCS  
CHEI TUBULARE**

**FESTA®**



CrV

17650	6x7 mm	10	17655	16x17 mm	10
17651	8x9 mm	10	17645	16x18 mm	10
17642	8x10 mm	10	17656	18x19 mm	10
17652	10x11 mm	10	17657	19x22 mm	10
17643	12x13 mm	10	17653	21x16 mm	10
17654	14x15 mm	10	17658	24x27 mm	10
17644	14x17 mm	10			

**VILLÁSKULCS KLT.  
SET CHEI FIXE**

**FESTA®**



CrV

17506	6 db/buc · 6x7, 8x9, 10x11, 12x13, 14x15, 16x17	40
17508	8 db/buc · 6x7, 8x9, 10x11, 12x13, 14x15, 16x17, 18x19, 20x22	24

**VILLÁSKULCS KLT.  
SET CHEI FIXE**

**FESTA®**



CrV

17512	12 db/buc · 6x7, 8x9, 10x11, 12x13, 14x15, 16x17, 18x19, 20x22, 21x23, 24x27, 25x28, 30x32	8
-------	--	---

**CSILLAG-VILLÁSKULCS KLT.  
SET CHEI COMBinate**

**FESTA®**



CrV

17526	6 db/buc · 10x10, 11x11, 13x13, 14x14, 16x16, 17x17	40
17528	8 db/buc · 8x8, 10x10, 11x11, 13x13, 14x14, 16x16, 17x17, 19x19	40

**CSILLAG-VILLÁSKULCS KLT.  
SET CHEI COMBinate**

**FESTA®**



CrV

17532	12 db/buc · 8x8, 9x9, 10x10, 11x11, 13x13, 14x14, 16x16, 17x17, 18x18, 19x19, 21x21, 22x22	16
17534	25 db/buc · 6x6 - 28x28, 30x30 - 32x32	4

CSILLAGKULCS KLT.  
SET CHEI INELARE COTITE



FESTA®



DIN 838

CrV



17539 8 db/buc · 6x7, 8x9, 10x11, 12x13, 14x15, 16x17, 18x19, 20x22

20

RACSNIS KULCS KÉSZLET  
CHEI COMBINATE CU CLICHET



FESTA®

72 fogú/zimti

CrV



17620 8-10-12-13-14-17-19

5

KAR CSŐKULCSHOZ  
LEVIER PENTRU TUBULARE



FESTA®

CrV



17640

50

KÖRMÖSKULCS  
CHEI LA POLIZOR UNGHIULAR



FESTA®



20968 115 - 230 mm

50

NYOMATÉK KULCS  
CLICHET DINAMOMETRIC REGLABIL



FESTA®



17203 1/4" 5-25 Nm

20

17204 1/2" 19-110 Nm

20

17205 1/2" 42-210 Nm

20

17206 3/4" 140-700 Nm

20

VILLÁSKULCS KÉSZLET  
SET CHEI FIXE



FESTA®



DIN 895

CrV



17475 8 db/buc · 6x7, 8x9, 10x11, 12x13, 14x15, 16x17, 18x19, 20x22

10

17476 12 db/buc · 6x7, 8x9, 10x11, 12x13, 14x15, 16x17, 18x19, 20x22, 21x23, 24x27, 28x30, 30x32

10

CSŐKULCS KLT.  
SET CHEI TUBULARE



FESTA®

CrV



17501 6x7, 8x9, 10x11, 12x13, 14x15, 16x17, 18x19,

20

ÁLLÍTHATÓ CSAVARKULCS,  
MŰA. MARKOLAT  
CHEI REGLABILE



FESTA®

CrV



17197 distanta · terjedelem/ lungime · hosszúság 29 /200 mm

64

17198 distanta · terjedelem/ lungime · hosszúság 33 /250 mm

32

17199 distanta · terjedelem/ lungime · hosszúság 38 /300 mm

24

ÁLLÍTHATÓ VILLÁSKULCS  
CHEI REGLABILE



FESTA®



17200 distanta · terjedelem/ lungime · hosszúság 24 /200 mm

6

17201 distanta · terjedelem/ lungime · hosszúság 30 /250 mm

6

17202 distanta · terjedelem/ lungime · hosszúság 34 /300 mm

6

KERÉK CSAVARKULCS  
CHEIE IN CRUCE PENTRU ROTI



FESTA®



17600 17, 19, 22 mm, 13/16"

20



▼ KERÉK CSAVARKULCS  
CHEIE IN CRUCE PENTRU ROTI

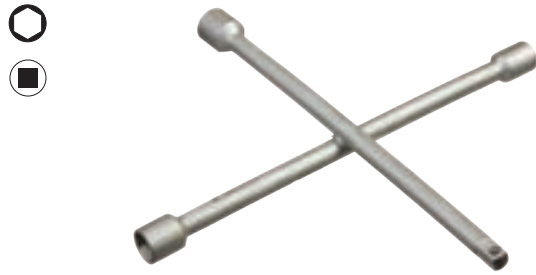

17601 17, 19, 21mm + ■1/2"



▼ KERÉK CSAVARKULCS  
CHEIE IN CRUCE PENTRU ROTI



17602 17, 19, 21, 23 mm



▼ KERÉKKULCS, TELESZKÓPOS  
COARBA TELESCOPICA ROTI



17603 17x19 mm, 21x23 mm 37 ↔ 54 cm



▼ GYERTYAKULCS  
CHEIE ARTICULATA BUJII CU CLICHET



17261 16 mm  
17262 21 mm



▼ SZERSZÁM KLT.  
SET UNELTE



17710 99 db/buc



▼ VIZSGÁLÓ TÜKÖR  
OGLINA INSPECTIE



13290 160 - 610 mm



▼ MÁGNESES FELSZEDŐ TELESZKÓPOS  
INSTRUMENT COLECTARE MAGNETIC



13293 160-610 mm



▼ MÁGNESES SZERSZÁMTARTÓ  
SUPPORT MAGNETIC PENTRU SCULE

**FESTA**



70098 610mm



**FESTA®**

magas minőségű csavarhúzó  
S2  
ergonomikus markolat  
akasztó lyuk a markolat végén

surubelnite de inalta calitate  
S2  
maner ergonomic  
lacas agatare

### CSAVARHÚZÓ LAPOS SURUBELNITE

**FESTA®****S2**

<b>18113</b>	3,5 x 75 mm	12
<b>18114</b>	4 x 100 mm	12
<b>18115</b>	5,5 x 125 mm	10
<b>18116</b>	6,5 x 150 mm	10
<b>18118</b>	8 x 175 mm	10
<b>18120</b>	10 x 200 mm	10

### CSAVARHÚZÓ LAPOS RÖVID SURUBELNITE SCURTE

**FESTA®****S2**

<b>NEW 18124</b>	5 x 38 mm	10
<b>18125</b>	6 x 38 mm	10

### CSAVARHÚZÓ PHILIPS SURUBELNITE PHILIPS

**FESTA®****S2**

<b>18210</b>	0 x 75 mm	10
<b>18211</b>	1 x 75 mm	12
<b>18212</b>	2 x 100 mm	12
<b>18213</b>	3 x 150 mm	10

### CSAVARHÚZÓ PHILIPS RÖVID SURUBELNITE PHILIPS SCURTE

**FESTA®****S2**

<b>NEW 18215</b>	1 x 38 mm	10
<b>18216</b>	2 x 38 mm	10

### CSAVARHÚZÓ POZIDRIVE SURUBELNITE POZIDRIVE

**FESTA®****S2**

<b>18310</b>	0 x 75 mm	10
<b>18311</b>	1 x 75 mm	10
<b>18312</b>	2 x 100 mm	12
<b>18313</b>	3 x 150 mm	10

### CSAVARHÚZÓ POZIDRIVE RÖVID SURUBELNITE POZIDRIVE SCURTE

**FESTA®****S2**

<b>18321</b>	1 x 38 mm	10
<b>18322</b>	2 x 38 mm	10

### CSAVARHÚZÓ TORX SURUBELNITE TORX

**NEW****S2**

<b>18350</b>	T 6	12	<b>18356</b>	T 20	12
<b>18351</b>	T 7	12	<b>18357</b>	T 25	12
<b>18352</b>	T 8	12	<b>18358</b>	T 27	12
<b>18353</b>	T 9	12	<b>18359</b>	T 30	12
<b>18354</b>	T 10	12	<b>18360</b>	T 40	12
<b>18355</b>	T 15	12			

CSAVARHÚZÓ LAPOS CrV  
SURUBELNITE CrV

FESTA®



18133	3x80 mm	12	
18134	4x100 mm	12	
18135	5x150 mm	12	
18136	6x150 mm	12	
18137	8x200 mm	12	
18230	4x300 mm	KITERJEDT / PRELUNGI	12
18231	5x300 mm	KITERJEDT / PRELUNGI	12

CSAVARHÚZÓ LAPOS CrV RÖVID  
SURUBELNITE POZIDRIVE CrV SCURTE

FESTA®



18140	5x38 mm	12
18141	6x38 mm	12

CSAVARHÚZÓ PHILIPS CrV  
SURUBELNITE PHILIPS CrV

FESTA®



18220	0x80 mm	12	
18221	1x100 mm	12	
18222	2x100 mm	12	
18223	3x150 mm	12	
18235	1x300 mm	KITERJEDT / PRELUNGI	12
18236	2x300 mm	KITERJEDT / PRELUNGI	12

CSAVARHÚZÓ PHILIPS CrV RÖVID  
SURUBELNITE PHILIPS CrV SCURTE

FESTA®



18224	1x38 mm	12
18225	2x38 mm	12

CSAVARHÚZÓ POZIDRIVE CrV  
SURUBELNITE POZIDRIVE CrV

FESTA®



18315	0x80 mm	12
18316	1x100 mm	12
18317	2x100 mm	12
18318	3x150 mm	12

CSAVARHÚZÓ POZIDRIVE CrV RÖVID  
SURUBELNITE POZIDRIVE CrV SCURTE

FESTA®



18319	1x38 mm	12
18320	2x38 mm	12

CSAVARHÚZÓ CrV TORX  
SURUBELNITE CrV TORX

FESTA®



18325	T 6	12	18331	T 20	12
18326	T 7	12	18332	T 25	12
18327	T 8	12	18333	T 27	12
18328	T 9	12	18334	T 30	12
18329	T 10	12	18335	T 40	12
18330	T 15	12			

CSAVARHÚZÓ LAPOS, ÜTHETŐ  
SURUBELNITE

FESTA®



CSAVARHÚZÓ PHILIPS, ÜTHETŐ  
SURUBELNITE PHILIPS

FESTA®



18070	PH1 x 80mm	10
18071	PH2 x 100mm	10
18072	PH3 x 150mm	10

CSAVARHÚZÓ POZIDRIVE, ÜTHETŐ  
SURUBELNITE POZIDRIVE

FESTA®



18075	PZ1 x 80mm	10
18076	PZ2 x 100mm	10
18077	PZ3 x 150mm	10

VDE SZIGETELT CSAVARHÚZÓ  
VDE SURUBELNITA CU IZOLATIE

FESTA®



CrV



18088	3x75mm	10
18089	4x100mm	10
18090	5,5x125mm	10
18091	6,5x150mm	10
18092	8x175mm	10

VDE SZIGETELT CSAVARHÚZÓ PHILIPS  
VDE SURUBELNITA CU IZOLATIE PHILIPS

FESTA®



CrV



18080	PH 0 x 60 mm	10
18081	PH 1 x 80 mm	10
18082	PH 2 x 100 mm	10
18083	PH 3 x 150 mm	10

VDE SZIGETELT CSAVARHÚZÓ POZIDRIVE  
VDE SURUBELNITA CU IZOLATIE POZIDRIVE

FESTA®



CrV



18084	PZ 0x60mm	10
18085	PZ 1x80mm	10
18086	PZ 2x100mm	10
18087	PZ 3x150mm	10

CSAVARHÚZÓ LAPOS  
SURUBELNITE

CrV



18101	3,5x75 mm	10
18102	4x100 mm	10
18103	5,5x100 mm	10
18104	5,5x125 mm	10
18105	6,5x100 mm	10
18106	6,5x125 mm	10
18107	8x160 mm	10
18108	10x160 mm	10

CSAVARHÚZÓ PHILIPS  
SURUBELNITE PHILIPS

CrV



18201	0x75 mm	10
18202	1x75 mm	10
18203	2x100 mm	10
18204	3x150 mm	10

CSAVARHÚZÓ POZIDRIVE  
SURUBELNITE POZIDRIVE

CrV



18301	0x75 mm	10
18302	1x75 mm	10
18303	2x100 mm	10
18304	3x150 mm	10

CSAVARHÚZÓ KLT  
SURUBELNITE SET

FESTA®



S2



18402	7 db/buc	⊖ 3 x 75, 5 x 100, 6 x 175mm	20
		⊕ PH0, PH1, PH2, PH3	
18403	6 db/buc	⊖ 3 x 75, 5 x 100, 6 x 150mm	20
		⊕ PH0, PH1, PH2	

CSAVARHÚZÓ KLT. CrV  
SURUBELNITE SET CrV

CrV



18400	7 db/buc	⊖ 3x60, 4x75, 6x100, 6x125mm	10
		⊕ PH0x60, PH1x75, PH2x100mm	
18401	5 db/buc	⊖ 3x60, 6x100, 6x125mm	50
		⊕ PH1x75, PH2x100mm	

CSAVARHÚZÓKÉSZLET BITEKSEL  
SET SURUBELNITE + BITURI

FESTA®



S3x75; S4x100; S5,5x125;  
S6,5x150;  
PH1x80; PH2x100;  
BITY: ⊖ S4,5; 6; 7;  
⊕ PH1; 2; 3;  
● T10; 15; 20; 25; 30; 40;  
⊗ H2; 3; 4; 5; 6;



S2



18422 27db/buc

12

CSAVARHÚZÓ KLT. ÉS BITEK  
SET SURUBELNITE

CrV



18418 21db/buc

10

CSAVARHÚZÓ TORX KLT. CrV  
SURUBELNITE TORX SET CrV

FESTA®



18340 5 db/buc • 10-15-20-25-30

20

CSAVARHÚZÓKÉSZLET  
SET SURUBELNITE + BITURI

Ø1/4"

S 3; 4; 5; 6; 7  
PH 0; 1; 2; 3;  
PZ 1; 2; 3  
T 10; 15; 20; 25;  
27; 30; 5; 6; 7;  
8; 9; 10 mmracsnis holeder bitek  
/ clichet holeder de biți

18419 26 db/buc



FESTA®



6

CSAVARHÚZÓKÉSZLET  
SET SURUBELNITE TS6x40, 5x80, 6x105, 8x150 mm  
S1, 5x50, 2x50, 2,5x50 mm  
PH 2x40, 1x80, 2x105, 3x150 mm  
PH 0x50, 00x50, 000x50 mm  
T 5x50, 6x50, 7x50 mm

FESTA®



10

18424 18 db/buc

CSAVARHÚZÓ  
SURUBELNITA  
Ø1/4"

FESTA®



18433 1/4"

50

CSAVARHÚZÓ GUMINYELŰ + BIT  
SURUBELNITA + BITURI

Ø1/4"



FESTA®



25

18425

T CSAVARHÚZÓ KLT. + 20 BIT  
SET SURUBELNITA T + 20 BITURI

FESTA®



18420

20

MÁGNESES T BITCSAVARHÚZÓ  
SURUBELNITA T CU ADAPTOR MAGNETIC PENTRU BITURI

Ø1/4"



FESTA®



10

18608

CSAVARHÚZÓ KLT. ÜTHETŐ  
SET SURUBELNITE CU CAP PERCUTIE

FESTA®



18423 6 db/buc

10

Ø 5-6-8 mm  
⊕ PH 1, PH 2, PH 3 mmÜTVECSAVARHÚZÓ  
SURUBELNITA + 4 BITURI

18411 6 db/buc

Ø 7x35, 8x35, 8x70 mm  
⊕ PH 2x35, PH 3x35, PH 3x70 mm

20

MŰSZERÉSZ CSAVARHÚZÓK  
SET SURUBELNITE DE PRECIZIE



**18416** 6 db/buc  $\ominus$  1,5x50, 2x50, 2,5 x 50 mm  
 $\oplus$  PH 000 x 50, PH 00 x 50, 0 x 50 mm

12

FINOM BITEK ADAPTEREKKEL  
SET BITURI DE PRECIZIE CU ADAPTOR



**FESTA**



**18431** 32 db/buc

10

ÓRÁS CSAVARHÚZÓ KLT.  
SET SURUBELNITE DE PRECIZIE



**18408** 6 db/buc  $\ominus$  1,4-2,0-2,4-3,0 mm  
 $\oplus$  PH 0, PH 1

12

MŰSZERÉSZ CSAVARHÚZÓK TORX  
SET SURUBELNITE DE PRECIZIE TORX



**18417** 7 db/buc 4, 5, 6, 7, 8, 9, 10 x 50 mm

12

MINI CSAVARHÚZÓ  
SET MINISURUBELNITE



A bitfejeket be lehet tenni a fogantyúba  
Biturile pot fi introduse in maner



**FESTA**



**18414** 7 db/buc  $\ominus$  2-2,5 mm  
 $\oplus$  PH 000, PH 00  $\star$  T4, T5

40

ÓRÁS CSAVARHÚZÓ KLT.  
SET SURUBELNITE DE PRECIZIE



**18409** 11 db/buc  $\ominus$  1,0-1,2-1,4-1,8-2,4-3,0 mm  
 $\oplus$  PH 00, PH 0, PH 1

48

CSAVARHÚZÓKÉSZLET  
SET SURUBELNITE T



2mm  
2,5mm  
3mm  
4mm  
5mm  
6mm  
7mm  
8mm  
10mm

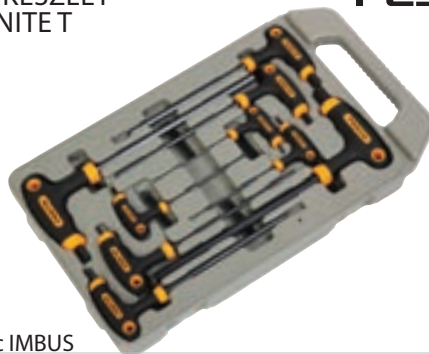

**FESTA**



**18494** 9 db/buc IMBUS

10

CSAVARHÚZÓKÉSZLET  
SET SURUBELNITE T



T10  
T15  
T20  
T25  
T27  
T30  
T40  
T45  
T50

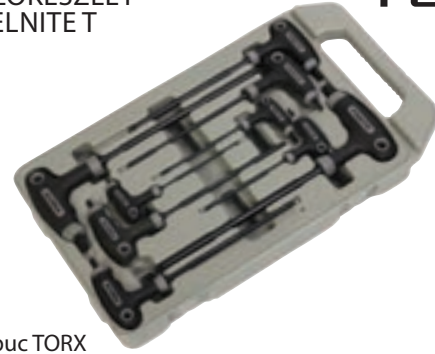

**FESTA**



**18495** 9 db/buc TORX

10

T CSAVARHÚZÓ IMBUS  
CHEIE CU MANER IMBUS



**FESTA**



<b>17365</b>	2	10	<b>17369</b>	5	10
<b>17366</b>	2,5	10	<b>17370</b>	6	10
<b>17367</b>	3	10	<b>17371</b>	8	10
<b>17368</b>	4	10	<b>17372</b>	10	10

T CSAVARHÚZÓ TORX  
CHEIE CU MANER TORX



**FESTA**



<b>17350</b>	T7	10	<b>17356</b>	T25	10
<b>17351</b>	T8	10	<b>17357</b>	T27	10
<b>17352</b>	T9	10	<b>17358</b>	T30	10
<b>17353</b>	T10	10	<b>17359</b>	T40	10
<b>17354</b>	T15	10	<b>17360</b>	T45	10
<b>17355</b>	T20	10	<b>17361</b>	T50	10

**SZIGETELT CSAVARHÚZÓ KLT.  
SET SURUBELNITE ELECTRICIAN**

**FESTA®**



1000 V  
IEC/EN60900:2004

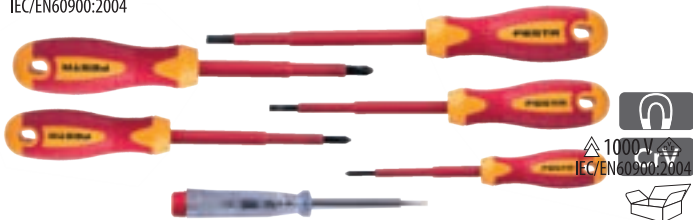

**18413** 6 db/buc



10

**SZIGETELT CSAVARHÚZÓ KLT.  
SURUBELNITE ELECTRICIAN**

**FESTA®**



1000 V  
IEC/EN60900:2004



**18410** 6 db/buc

1000 V  
IEC/EN60900:2004



40

**FLEXI CSAVARHÚZÓ TÖMLŐKÖTÉSRE  
SURUBELNITA FLEXIBILA PENTRU COLIERE**

**FESTA®**

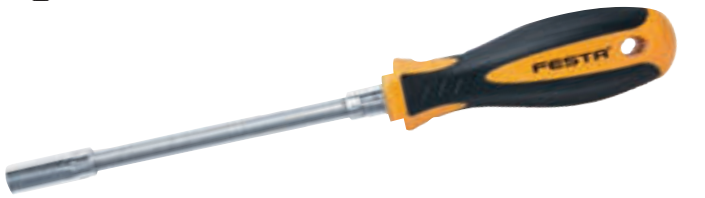

**18450** 7 mm



12

**CSAVARBEHÚZÓ CSAVARHÚZÓ  
SURUBELNITA CU CHEIE**

**FESTA®**



CrV



**18455** 6 mm  
**18457** 8 mm  
**18458** 10 mm  
**18460** 13 mm

12

12

12

12

**SÖRNYITÓ  
DESCHIZĂTOR DE STICLE**

**FESTA®**

**NEW**



**18437**



12

**MŰSERÉSZ CSAVARHÚZÓK  
SET SURUBELNITE ELECTRICIAN**



**18415** 6 db/buc



10

**FÁZISKERESŐ  
SURUBELNITA TESTER**



DIN VDE 0680  
73/23 EEC



**18426** 0-250V



50

**FLEXI CSAVARHÚZÓ TÖMLŐKÖTÉSRE  
SURUBELNITA FLEXIBILA PENTRU COLIERE**

**FESTA®**



**18451** 1/4"



12

**ADAPTER DUGÓKULCSOKHOZ  
ADAPTOR PENTRU CHEI HEXAGONALE**



**18603** 1/4" 150 mm

CrV



10



Biték - profesionalis csavarhúzó toldatok a legjobb minőségű CrV S2 anyagból  
Bituri - profesionale de inalta calitate, material CrV S2

## STAHLBERG gyártócég

világmárka a csavarhúzó toldatok gyártók között, sok éves tapasztalatokkal és vásárlókkal az egész világon. A gyártásnál felhasználja a legújabb technológiákat és az eddig legjobb kifejlesztésű anyagokat és felületi megmunkálásokat

## producator STAHLBERG

marca comerciala a unui producator mondial de accesorii de insurubat cu vasta experienta in domeniul si cu clienti in toata lumea. Pentru productie se folosesc cele mai noi tehnologii, cele mai bune materiale si straturi de acoperire

## S2 anyag

acél ötvözött titánnal, kobalttal, krómmal és molibdénal. Erre a használatra speciálisan kifejlesztett anyag. A keménység és szívósság közötti megfelelő arányt érték el edzés után. A hegyek keménysége eléri a 61-62 HRC-t.

## Material S2

otel in aliaj cu titaniu, cobalt, crom si molibden. Material conceput special pentru aceasta utilizare. Dupa calire se formeaza o legatura excelenta intre duritate si tenacitate. Duritatea capetelor ajunge pana la 61-62 HRC.

## gyártás technológiája

Kereszt és lapos csavarhúzó toldatok speciális technológiával vannak gyártva pontos kovácsolással. Amely lehetővé teszi a forma magas pontosságát és egyúttal magasabb szilárdságot is a bit megmunkálásával szemben 20%-kal. A bitek kovácsolás után az optimális keménység és szívósság elérésére edzve vannak. Rozsdamentesség elérése érdekében. További homokozással vannak kezelve.

## Atasamente forjate

crucea si corpul bitului, sunt facute conform unei tehnologii speciale de forjare exacta. Aceasta permite atingerea unui inalt nivel de acuratete in privinta formei, o data cu cresterea duritatii in comparatie cu bitii cu 20%.



## TiN réteg

Kétszeres felvétele a csavarhúzóhegyére maximálisan emeli a felület keménységét, ütésállóságát és. A surlódási tulajdonságot, mely meggátolja a befogásból való kicsúszást. TiN réteg korrozioálló is.

## strat TiN

acoperire dubla aplicata pe suprafata bitilor, creste maxim duritatea, rezistenta la frecare previne alunecarea din cupla. Este testat la corziune.

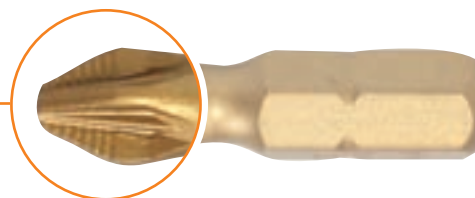

## Gyémánszemcsék

A hegy felületén szórószert, „beharapnak” a csap vagy csavar fejébe és megtartja a bitet a maximális becsavarási pillanatig. A legjobb biztosítékok a befogásban maradáshoz. A csaváros bitek leggyakrabban a befogásból történő kicsúszáskor sérülnek meg. A csavaró pillanat most átvivődik a minimális felületre, amelyik deformálódik.

## Granule de diamante

suprafata biturilor de insurubare „musca” efectiv din capatul surubului de lemn si permit transferul maxim al momentului de torsiune. Este garantia ca bitul va ramane in cuplaj.

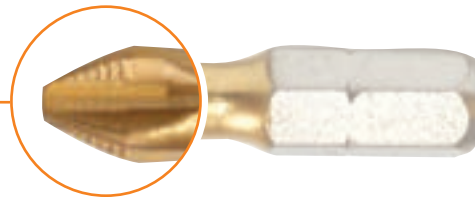

## Csúszásgátló vágások

A csavarhegyek kovácsolással készült munkafelületén további nagyon hatásos védelem a befogásból történő kicsúszás ellen.

## Caneluri antialunecare

pe suprafetele de lucru ale crampoanelor de insurubat facute prin forjare se afla caneluri de protectie eficiente contra alunecarii din angrenaj

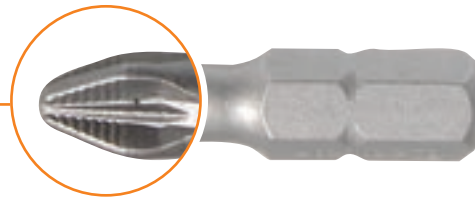



**BIT PH GYÉMÁNTOK**  
**BIT PH DIAMANT**



**TIN**  
**S2**

<b>18770</b>	10 db/buc	PH1, 25 mm, DIAMANT, DIN 3128	1
<b>18771</b>	10 db/buc	PH2, 25 mm, DIAMANT, DIN 3128	1
<b>18772</b>	10 db/buc	PH3, 25 mm, DIAMANT, DIN 3128	1

**IT PZ GYÉMÁNTOK**  
**BIT PZ DIAMANT**



**TIN**  
**S2**

<b>18775</b>	10 db/buc	PZ1, 25 mm, DIAMANT, DIN 3128	1
<b>18776</b>	10 db/buc	PZ2, 25 mm, DIAMANT, DIN 3128	1
<b>18777</b>	10 db/buc	PZ3, 25 mm, DIAMANT, DIN 3128	1

**BIT PH**



**S2**

<b>18630</b>	10 db/buc	PH0, 25 mm, S2	1
<b>18631</b>	10 db/buc	PH1, 25 mm, S2	1
<b>18632</b>	10 db/buc	PH2, 25 mm, S2	1
<b>18633</b>	10 db/buc	PH3, 25 mm, S2	1
<b>18634</b>	10 db/buc	PH4, 25 mm, S2	1

**BIT PZ**



**S2**

<b>18635</b>	10 db/buc	PZ0, 25 mm, S2	1
<b>18636</b>	10 db/buc	PZ1, 25 mm, S2	1
<b>18637</b>	10 db/buc	PZ2, 25 mm, S2	1
<b>18638</b>	10 db/buc	PZ3, 25 mm, S2	1
<b>18639</b>	10 db/buc	PZ4, 25 mm, S2	1

**BIT PH - 70mm**



**S2**

<b>18640</b>	10 db/buc	PH 1, S2	1
<b>18641</b>	10 db/buc	PH 2, S2	1

**BIT PZ - 70mm**



**S2**

<b>18645</b>	10 db/buc	PZ 1, S2	1
<b>18646</b>	10 db/buc	PZ 2, S2	1

**BIT PH TITAN NITRID**



**TIN**  
**S2**

<b>18760</b>	10 db/buc	PH 0, 25 mm, TiN S2	1
<b>18761</b>	10 db/buc	PH 1, 25 mm, TiN S2	1
<b>18762</b>	10 db/buc	PH 2, 25 mm, TiN S2	1
<b>18763</b>	10 db/buc	PH 3, 25 mm, TiN S2	1
<b>18764</b>	10 db/buc	PH 4, 25 mm, TiN S2	1

**BIT PZ TITAN NITRID**



**TIN**  
**S2**

<b>18765</b>	10 db/buc	PZ 0, 25 mm, TiN S2	1
<b>18766</b>	10 db/buc	PZ 1, 25 mm, TiN S2	1
<b>18767</b>	10 db/buc	PZ 2, 25 mm, TiN S2	1
<b>18768</b>	10 db/buc	PZ 3, 25 mm, TiN S2	1
<b>18769</b>	10 db/buc	PZ 4, 25 mm, TiN S2	1

**BIT S**



**S2**

<b>18620</b>	10 db/buc	S 3,0 mm, 25 mm, S2	1
<b>18621</b>	10 db/buc	S 4,0 mm, 25 mm, S2	1
<b>18623</b>	10 db/buc	S 5,0 mm, 25 mm, S2	1
<b>18625</b>	10 db/buc	S 6,0 mm, 25 mm, S2	1
<b>18627</b>	10 db/buc	S 7,0 mm, 25 mm, S2	1
<b>18628</b>	10 db/buc	S 8,0 mm, 25 mm, S2	1

**BIT S TITAN NITRID**



**TIN**  
**S2**

<b>18750</b>	10 db/buc	S 3,0 mm, 25 mm, TiN S2	1
<b>18751</b>	10 db/buc	S 4,0 mm, 25 mm, TiN S2	1
<b>18753</b>	10 db/buc	S 5,0 mm, 25 mm, TiN S2	1
<b>18755</b>	10 db/buc	S 6,0 mm, 25 mm, TiN S2	1

**BIT H**



**S2**

<b>18800</b>	10 db/buc	H 1,5 mm, 25 mm, S2	1
<b>18801</b>	10 db/buc	H 2,0 mm, 25 mm, S2	1
<b>18802</b>	10 db/buc	H 2,5 mm, 25 mm, S2	1
<b>18803</b>	10 db/buc	H 3,0 mm, 25 mm, S2	1
<b>18804</b>	10 db/buc	H 4,0 mm, 25 mm, S2	1
<b>18805</b>	10 db/buc	H 5,0 mm, 25 mm, S2	1
<b>18806</b>	10 db/buc	H 5,5 mm, 25 mm, S2	1
<b>18807</b>	10 db/buc	H 6,0 mm, 25 mm, S2	1



**BIT HTa**



**S2**



<b>18810</b>	10 db/buc	HTa 1,5 mm, 25 mm, S2	1
<b>18811</b>	10 db/buc	HTa 2,0 mm, 25 mm, S2	1
<b>18812</b>	10 db/buc	HTa 2,5 mm, 25 mm, S2	1
<b>18813</b>	10 db/buc	HTa 3,0 mm, 25 mm, S2	1
<b>18814</b>	10 db/buc	HTa 4,0 mm, 25 mm, S2	1
<b>18815</b>	10 db/buc	HTa 5,0 mm, 25 mm, S2	1
<b>18816</b>	10 db/buc	HTa 5,5 mm, 25 mm, S2	1
<b>18817</b>	10 db/buc	HTa 6,0 mm, 25 mm, S2	1

**BIT T** 







18820	10 db/buc	T 5, 25 mm, S2	1
18821	10 db/buc	T 6, 25 mm, S2	1
18822	10 db/buc	T 7, 25 mm, S2	1
18823	10 db/buc	T 8, 25 mm, S2	1
18824	10 db/buc	T9, 25 mm, S2	1
18825	10 db/buc	T 10, 25 mm, S2	1
18826	10 db/buc	T 15, 25 mm, S2	1
18827	10 db/buc	T 20, 25 mm, S2	1
18828	10 db/buc	T 25, 25 mm, S2	1
18829	10 db/buc	T 27, 25 mm, S2	1
18830	10 db/buc	T 30, 25 mm, S2	1
18831	10 db/buc	T 40, 25 mm, S2	1
18832	10 db/buc	T 45, 25 mm, S2	1

**BIT SQ** 







18850	10 db/buc	SQ 0, 25 mm, S2	1
18851	10 db/buc	SQ 1, 25 mm, S2	1
18852	10 db/buc	SQ 2, 25 mm, S2	1
18853	10 db/buc	SQ 3, 25 mm, S2	1

**BIT TTa** 







18835	10 db/buc	TTa 5, 25 mm, S2	1
18836	10 db/buc	TTa 6, 25 mm, S2	1
18837	10 db/buc	TTa 7, 25 mm, S2	1
18838	10 db/buc	TTa 8, 25 mm, S2	1
18839	10 db/buc	TTa 9, 25 mm, S2	1
18840	10 db/buc	TTa 10, 25 mm, S2	1
18841	10 db/buc	TTa 15, 25 mm, S2	1
18842	10 db/buc	TTa 20, 25 mm, S2	1
18843	10 db/buc	TTa 25, 25 mm, S2	1
18844	10 db/buc	TTa 27, 25 mm, S2	1
18845	10 db/buc	TTa 30, 25 mm, S2	1
18846	10 db/buc	TTa 40, 25 mm, S2	1
18847	10 db/buc	TTa 45, 25 mm, S2	1

**BIT SD** 

18855	10 db/buc	SD 6, 25 mm, S2	1
18856	10 db/buc	SD 8, 25 mm, S2	1

**BIT TW** 

18860	10 db/buc	TW 1, 25 mm, S2	1
18861	10 db/buc	TW 2, 25 mm, S2	1
18862	10 db/buc	TW 3, 25 mm, S2	1
18863	10 db/buc	TW 4, 25 mm, S2	1

**BIT TS** 







18864	10 db/buc	TS 4, 25 mm, S2	1
18865	10 db/buc	TS 6, 25 mm, S2	1

**BIT 5/32", 3/16"** 





18866	10 db/buc	5/32, 25 mm, S2	1
18867	10 db/buc	3/16, 25 mm, S2	1



**BIT XZN** 

18870	M4, 25mm,S2,10 db/buc	1
18871	M5, 25mm,S2,10 db/buc	1
18872	M6, 25mm,S2,10 db/buc	1
18873	M8, 25mm,S2,10 db/buc	1
18874	M10, 25mm,S2,10 db/buc	1

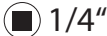
**BIT ADAPTER BITURI ADAPTOARE** 

 1/4"

18868	5 db/buc	1/4, 25 mm, S2	1
18869	5 db/buc	1/4, 50 mm, S2	1

**GIPSKARTON BIT HOSSZÍTOTT BIT PENTRU GIPS - PRELUNGIT** 



18796	2 db/buc	PH 2 x 55 mm	20
-------	----------	--------------	----

**GIPSKARTON BIT BIT PENTRU GIPS** 



18795	2 db/buc	PH 2 x 25 mm	20
-------	----------	--------------	----

BIT BEFOGÓ BEHAJTÓHOZ, MÁGNESES **Stahlberg**  
ADAPTOR BITURI, MAGNETIC

1/4"



18797 1/4" 60 mm, 1db/buc

50

BIT BEFOGÓ BEHAJTÓHOZ, MÁGNESES **Stahlberg**  
ADAPTOR BITURI, MAGNETIC

1/4"



18798 1/4" 60 mm, Gyorstapadó / desprindere rapida, 1db/buc

50

BIT BEFOGÓ BEHAJTÓHOZ, MÁGNESES **Stahlberg**  
ADAPTOR BITURI, MAGNETIC

1/4"



18602 1/4" 60 mm, Ütközővel / soclu filetat, 5db/buc

20

BIT BEFOGÓ, ÁLLÍTHATÓ  
SUPORT BITURI

1/4"



18607 80 mm

25

ADAPTER 1/4"  
ADAPTOR 1/4"

1/4"



18610 6 mm, 5db/buc

18611 7 mm, 5db/buc

18612 8 mm, 5db/buc

18613 10 mm, 5db/buc

18614 12 mm, 5db/buc

18615 13 mm, 5db/buc

1

1

1

1

1

1

BIT BEFOGÓ BEHAJTÓHOZ, MÁGNESES **Stahlberg**  
ADAPTOR BITURI, MAGNETIC

1/4"



18799 1/4" 60 mm, Ütközővel / soclu filetat, 1db/buc

50

BIT BEFOGÓ BEHAJTÓHOZ, MÁGNESES **Stahlberg**  
ADAPTOR BITURI, MAGNETIC

1/4"



18600 1/4" 60 mm, 5db/buc

20

BIT BEFOGÓ BEHAJTÓHOZ, MÁGNESES **Stahlberg**  
ADAPTOR BITURI, MAGNETIC

1/4"



18601 1/4" 60 mm, Gyorstapadó / desprindere rapida, 5db/buc

20

ADAPTER RACSNHOZ 1/4"  
ADAPTOR CLICHET-BITURI 1/4"

**Stahlberg**

1/4" ↔ 1/4"

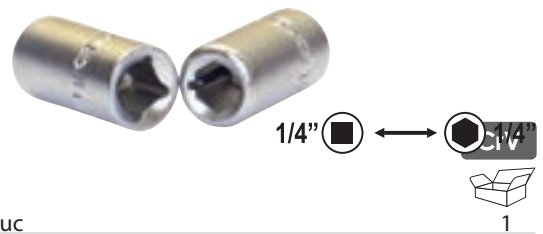

18619 5db/buc

1

CSAVARBEHAJTÓ KLT. MÁGNESES  
SET ADAPTOARE MAGNETIC

1/4"



18618 8 db/buc · 1/4" · 5, 6, 7, 8, 10, 11, 12, 13 mm

10

BIT ÉS ADAPTER KÍNÁLÓ KLT.  
BITURI SI ADAPTOARE

⊕ 18630	PH0	⊕ 18770	PH1	GYÉMÁNTOK/DIAMANT
⊕ 18631	PH1	⊕ 18771	PH2	GYÉMÁNTOK/DIAMANT
⊕ 18632	PH2	⊕ 18775	PZ1	GYÉMÁNTOK/DIAMANT
⊕ 18633	PH3	⊕ 18776	PZ2	GYÉMÁNTOK/DIAMANT
⊕ 18635	PZ0	⊕ 18814	4,0HTa	
⊕ 18636	PZ1	⊕ 18815	5,0HTa	
⊕ 18637	PZ2	⊕ 18842	20TTa	
⊕ 18638	PZ3	⊕ 18845	30TTa	
⊕ 18761	PH1 TiN	⊕ 18795	PH2	
⊕ 18762	PH2 TiN		GIPS	
⊕ 18763	PH3 TiN	18612	ADAPTER 1/4" 8mm	
⊕ 18766	PZ1 TiN	18613	ADAPTER 1/4" 10mm	
⊕ 18767	PZ2 TiN	18600	BIT BEFOGÓ BEHAJTÓHOZ, MÁGNESES / PORTBIT	
⊕ 18768	PZ3 TiN		MAGNETIC 1/4" 60mm	
		18601	BIT BEFOGÓ BEHAJTÓHOZ, MÁGNESES / PORTBIT	
			MAGNETIC 1/4" 60mm Gyorstapadó / desprindere rapida	
		18602	BIT BEFOGÓ BEHAJTÓHOZ, MÁGNESES / PORT-	
		BIT	MAGNETIC 1/4" 65mm Űtközővel / socu filetat	



GIPSKARTON BIT / BIT PENTRU

18993

S2

BIT KÍNÁLÓ KLT.  
BITURI

⊕ 18631	PH1	● 18804	H 4 mm
⊕ 18632	PH2	● 18805	H 5 mm
⊕ 18633	PH3	● 18825	T 10
⊕ 18636	PZ1	● 18826	T 15
⊕ 18637	PZ2	● 18827	T 20
⊕ 18638	PZ3	● 18828	T 25
⊕ 18761	PH1 TiN	● 18830	T 30
⊕ 18762	PH2 TiN	● 18831	T 40
⊕ 18763	PH3 TiN		
⊕ 18766	PZ1 TiN		
⊕ 18767	PZ2 TiN		
⊕ 18768	PZ3 TiN		



18994

S2

BIT KLT.  
SET BITURI

FESTA®

1/4"



- ⊕ 3, 4, 5, 6
- 1, 2, 2, 3
- ⊖ 3, 4, 5, 6
- 1, 2, 2, 3
- ⊕ T10, T15, T20, T25, T27, T30, T40
- ⊕ 10, 15, 20, 25, 27, 30, 40

magneses gyorskioldó  
bittartó/ suport rapid de  
presă bit

S2



18905 32 db/buc

BIT KLT.  
SET BITURI

FESTA®

1/4"



- ⊕ 1, 1, 1, 2, 2, 2, 3, 3, 3,
- ⊖ 4, 4, 5, 5, 6, 6
- T15, T20, T20, T25, T25, T30, T30,  
T30, T40, T40
- ⊕ 10, 15, 20, 25, 27, 30, 40
- ⊕ 1, 1, 1, 2, 2, 2, 3, 3, 3
- 3, 4, 5

magneses gyorskioldó  
bittartó/ suport rapid de  
presă bit

S2



18906 56 db/buc

**BIT KLT.  
SET BITURI**

- ⊕ 2, 2.5, 3, 4, 5, 6,  
5/32", 9/64", 1/8", 7/64", 3/32", 5/64"
  - ⊖ 6, 8, 10
  - ⊕ 6, 8, 10
  - ⊖ 1, 2, 3, 4
  - ⊗ T8, T10, T15, T20, T25, T27, T30,  
T35, T40
- Mágneses toldalék bitekre  
portbit magnetic



S2



**18900** 33 db/buc, S2

**BIT KLT.  
SET BITURI**

- ⊖ 3, 4, 5, 6, 7
  - ⊕ 1, 1, 2, 2, 2, 3, 3
  - ⊖ 2, 2.5, 3, 4, 5, 6
  - ⊕ 0, 1, 1, 2, 2, 2, 3, 3
  - ⊗ T10, T15, T20, T25, T30, T40
- Mágneses toldalék bitekre  
portbit magnetic



S2



**18901** 33 db/buc, S2

**BIT KLT.  
SET BITURI**

- ⊕ 1, 2, 3
- ⊖ 5, 6, 7
- ⊖ 1, 2
- ⊖ 1.5, 2, 2.5, 3, 4, 5, 5.5, 6
- ⊗ T10, T15, T20, T25, T27, T30, T40, T45
- ⊖ 1/4" · 4, 5, 6, 7, 8, 9, 10,  
5/32", 3/16", 7/32", 1/4",  
9/32", 5/16", 3/8"

Csavarhúzó toldalék – hosszabbító / surubelnita cu  
portbit

Mágneses toldalék bitekre/portbit magne-  
tis



**18915** 40 db/buc

**BIT KLT.  
SET BITURI**

- ⊖ S3; 5; 7
- ⊕ PH1; 2; 3



**18430** 7db/buc

**BIT KLT.  
SET BITURI**

- ⊖ 0, 1, 2, 3
- ⊕ 0, 1, 2, 2, 2, 2, 2, 3
- ⊕ 0, 1, 2, 2, 2, 2, 2, 3
- ⊖ 3, 4, 4.5, 5, 5, 5.5, 6, 6.5, 7, 8
- ⊗ T8, T10, T15, T20, T25, T27, T30, T40, T45
- ⊗ T8, T10, T15, T20, T25, T27, T30, T35, T40
- ⊗ 1.5, 2, 2.5, 3, 4, 5, 5.5, 6, 8mm, 1/16", 5/64",  
3/32", 7/64", 1/8", 9/64", 5/32", 3/16", 7/32"
- ⊖ 1/4"
- 2, 2.5, 3, 4, 5, 6mm,  
5/64", 3/32", 7/64", 1/8", 9/64", 5/32"
- ⊖ calliper: 4, 6, 8, 10
- 4-wing: 6, 8, 10
- 3-wing: 1, 2, 3, 4
- 2-wing: 1, 2, 3
- ⊖ 5, 6, 8
- ⊖ Mágneses toldalék bitekre
- ⊖ portbit magnetic

toldalék bitekre  
portbit Y

1/4" DR Csavarhúzó toldalék – hosszabbító  
surubelnita cu portbit  
1/4" bit adapter: 25mm, 50mm



S2



**18909** 100 db/buc, S2

**BIT KLT.  
SET BITURI**

- ⊕ 1, 2, 3
- ⊖ 3, 4, 4.5, 5, 5.5, 6, 7
- ⊖ 1, 2, 3
- ⊖ 2, 3, 4, 5,
- ⊗ T20, T30
- ⊖ 1/4" · 4, 4.5, 5, 5.5, 6, 7, 8, 9, 10,  
5/32", 3/16", 7/32", 1/4", 9/32",  
5/16", 11/32", 3/8", 7/16"

Mágneses csavarhúzó / magnetic surubelnite  
toldalék bitekre / portbit  
2 db/buc adapter



**18916** 41 db/buc

**BIT KLT.  
SET BITURI**

- ⊖ 4, 5, 6, 7
- ⊕ 1, 2, 3
- ⊖ 4, 5, 6
- ⊖ 1, 2, 3
- ⊗ T10, T15, T20, T25
- ⊗ 1, 2, 3



**18907** 20 db/buc, S2

BIT KLT.  
SET BITURI



CrV



18440 10 db/buc

10

IMBUSZKULCS KLT. CrV  
SET CHEI IMBUS CrV

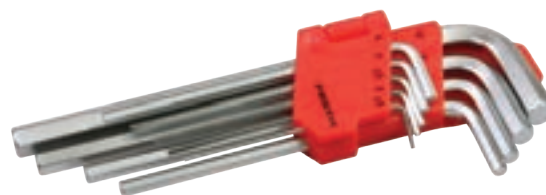

CrV



18496 9 db/buc 1,5-2-2,5-3-4-5-6-8-10 mm

10

IMBUSZKULCS KLT. CrV HOSSZÍTOTT  
SET CHEI IMBUS CrV

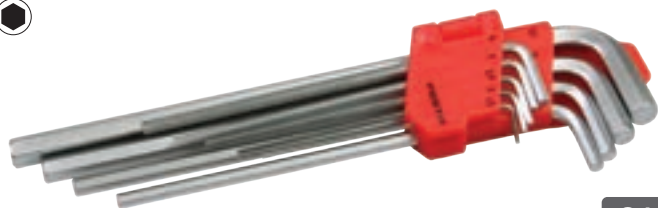

CrV



18490 9 db/buc 1,5-2-2,5-3-4-5-6-8-10 mm

10

TORXKULCS KLT. CrV  
SET CHEI TORX CrV



CrV



18497 9 db/buc T10-15-20-25-27-30-40-45-50

10

TORXKULCS KLT. CrV HOSSZÍTOTT  
SET CHEI TORX CrV

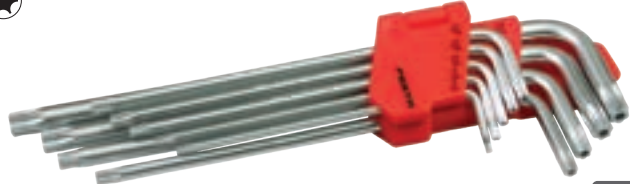

CrV



18491 9 db/buc T10-15-20-25-27-30-40-45-50

10

IMBUSZKULCS KLT. CrV  
SET CHEI IMBUS CrV

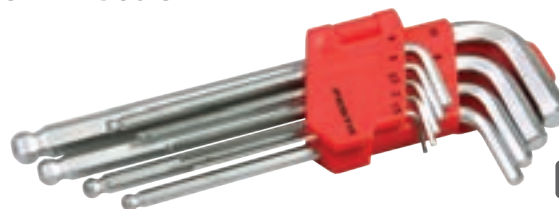

CrV



18498 9 db/buc 1,5-2-2,5-3-4-5-6-8-10 mm  
18493 9 db/buc 1/16"-5/64"-3/32"-1/8"-5/32"-3/16"  
-1/4"-5/16"-3/8"

10

10

IMBUSZKULCS KLT. CrV HOSSZÍTOTT  
SET CHEI IMBUS CrV

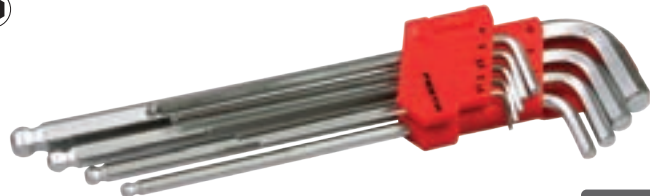

CrV



18492 9 db/buc 1,5-2-2,5-3-4-5-6-8-10 mm

10

IMBUSZKULCS KLT. CrV  
SET CHEI IMBUS CrV



CrV



18507 7 ks/pcs 2-8 mm  
18509 9 ks/pcs 1,5-6 mm

10

IMBUSZKULCS KLT. CrV  
SET CHEI IMBUS CrV



HOBBY



18499 8 db/buc, 2-10 mm

100

IMBUSZKULCS  
IMBUS

FESTA®



DIN 911

CrV



18540	1,5mm	14x45mm	1
18541	2mm	16x50mm	1
18542	2,5mm	18x56mm	1
18543	3mm	20x63mm	1
18544	4mm	25x70mm	1
18545	5mm	28x80mm	1
18546	6mm	32x90mm	1
18547	7mm	34x95mm	1
18548	8mm	36x100mm	1
18550	10mm	40x112mm	1
18551	11mm	42x120mm	1
18552	12mm	45x125mm	1
18553	13mm	50x130mm	1
18554	14mm	56x140mm	1
18557	17mm	63x160mm	1
18559	19mm	70x180mm	1
18562	22mm	80x200mm	1
18567	27mm	100x250mm	1
18572	32mm	125x315mm	1

IMBUSZKULCS  
IMBUS

FESTA®



CrV



18575	1,5mm	15x75mm	1
18576	2mm	17x81mm	1
18577	2,5mm	18x87mm	1
18578	3mm	20x96mm	1
18579	4mm	24x107mm	1
18580	5mm	30x120mm	1
18581	6mm	33x136mm	1
18582	7mm	34x144mm	1
18583	8mm	36x153mm	1
18585	10mm	40x171mm	1
18586	11mm	40x230mm	1
18587	12mm	42x250mm	1
18588	13mm	45x260mm	1
18589	14mm	56x280mm	1
18593	17mm	61x290mm	1

IMBUSZ KULCS  
IMBUS

FESTA®



CrV



18510	1,5mm	15x75mm	1
18511	2mm	17x81mm	1
18512	2,5mm	18x87mm	1
18513	3mm	20x96mm	1
18514	4mm	24x107mm	1
18515	5mm	30x120mm	1
18516	6mm	33x136mm	1
18518	8mm	36x153mm	1
18520	10mm	40x171mm	1
18521	11mm	40x230mm	1
18522	12mm	42x250mm	1
18523	13mm	45x260mm	1
18524	14mm	56x280mm	1
18527	17mm	61x290mm	1

IMBUSZ KULCS - TORX  
IMBUS - TORX

NEW



FESTA®



CrV



18465	T6		1
18466	T7		1
18467	T8		1
18468	T9		1
18469	T10		1
18470	T15		1
18471	T20		1
18472	T25		1
18473	T27		1
18474	T30		1
18475	T40		1
18476	T45		1
18477	T50		1

**KALAPÁCS PROFI KŐRISFA  
CIOCAN PROFI**

**FESTA®**



DIN 1041  
Körék / pana circulara  
kőris nyél - cseh termék  
/ Coadă Frasin - Fabricat în Cehia

19081	100 g	12
19082	200 g	12
19083	300 g	6
19084	400 g	6
19085	500 g	6
19086	600 g	6

19088	800 g	6
19090	1000 g	6
19092	1500 g	6
19095	2000 g	6
19096	3000 g	6
19097	4000 g	6
19098	5000 g	6

**KALAPÁCS  
CIOCAN**



Körék / pana circulara

19001	100 g	6
19002	200 g	10
19003	300 g	10
19004	400 g	6
19005	500 g	6

19006	600 g	6
19008	800 g	6
19010	1000 g	6
19015	1500 g	6
19020	2000 g	6

**KÉZIKALAPÁCS  
CIOCAN**

**FESTA®**



DIN 6475  
Körék / pana circulara  
kőris nyél - cseh termék  
/ Coadă Frasin - Fabricat în Cehia

19074	5000 g	1
19075	6000 g	1
19076	8000 g	1
19077	10000 g	1

**KÉZIKALAPÁCS  
CIOCAN**



Körék / pana circulara

19050	1250 g	6
19053	1000 g	6
19054	1500 g	6

19055	2000 g	6
19056	3000 g	6
19057	4000 g	4

**KALAPÁCS ÜVEGSZÁLAS NYÉL  
CIOCAN MANER FIBRA**

**FESTA®**



19021	100 g	12
19022	200 g	12
19023	300 g	12
19024	400 g	12
19025	500 g	12

19026	600 g	12
19028	800 g	24
19030	1000 g	24
19031	1500 g	12
19032	2000 g	12

**KALAPÁCS ÜVEGSZÁLAS  
CIOCAN MANER**

**FESTA®**



19066	1000 g	6
19067	1250 g	4
19068	1500 g	4
19069	2000 g	4

19070	3000 g	6
19071	4000 g	4
19058	5000 g	4
19059	6000 g	4

**PALÁZÓ KALAPÁCS ÜVEGSZÁLAS NYÉL  
CIOCAN DULGHER MANER FIBRA**

**FESTA®**



19061 600 g

**KALAPÁCS ÜVEGSZÁLAS NYÉL  
CIOCAN MANER FIBRA**

**FESTA®**



19034 3000 g  
19036 4000 g

**SUSZTER KALAPÁCS ÜVEGSZÁLAS NYÉL  
CIOCAN CU VARF DESPICAT, MANER FIBRA**

**FESTA®**



19064 450 g

**KÖMŰVES KALAPÁCS ÜVEGSZÁLAS NYÉL  
CIOCAN ZIDAR MANER FIBRA**

**FESTA®**



19151 48 mm



▼ PALÁZÓ KALAPÁCS MONOLIT  
CIOCAN CU VARF SPINTECAT

**FESTA**



**19062** 600 g, magnet



6

▼ SUSZTER KALAPÁCS MONOLIT  
IOCAN CU VARF SPINTECAT MONOLIT

**FESTA**



**19063** 450 g



6

▼ KŐMŰVES KALAPÁCS MONOLIT  
CIOCAN ZIDAR MONOLIT

**FESTA**



**19150** 600 g



6

▼ PALÁZÓ KALAPÁCS  
CIOCAN PENTRU DULGHER



**19100** 600 g



1

▼ KŐMŰVES KALAPÁCS  
CIOCAN ZIDAR

**FESTA**



**19149** 44 mm

Bükkfa nyél - cseh termék  
/ maner de fag - Fabricat in Cehia



1

▼ KŐMŰVES KALAPÁCS  
CIOCAN ZIDAR

**FESTA**



Bükkfa nyél - cseh termék  
/ maner de fag - Fabricat in Cehia

**19124** 24 mm  
**19136** 36 mm  
**19148** 48 mm



1

1

1

▼ KŐMŰVES KALAPÁCS  
CIOCAN ZIDAR

**Zbirovia**



**19122** 44 mm  
**61240** nyél/ maner

Bükkfa nyél - cseh termék  
/ maner de fag - Fabricat in Cehia



1

1

▼ SUSZTER KALAPÁCS  
CIOCAN CU VARF SPINTECAT



**19065** 600 g



6

▼ PALÁZÓ KALAPÁCS  
CIOCAN PENTRU DULGHER

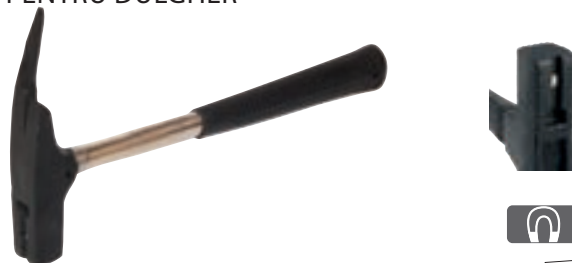

**19060** 600 g



6

▼ NYÉL  
MÄNER



<b>61242</b>	30 cm	25	<b>61246</b>	60 cm	25
<b>61243</b>	35 cm	25	<b>61247</b>	70 cm	10
<b>61244</b>	40 cm	25	<b>61248</b>	80 cm	10
<b>61245</b>	50 cm	25	<b>61249</b>	90 cm	10
			<b>61239</b>	90 cm	10



KÉZIKALAPÁCS  
CIOCAN



19051 1000 g  
19052 1500 g



Zbirovia

HEGESZTŐ KALAPÁCS  
CIOCAN SUDURA



19115 300g



FAKALAPÁCS  
CIOCAN



19202 Ø 60x120mm, 350g, bükkfa /fag



FESTA®



FAKALAPÁCS  
CIOCAN



19200 80x60 mm, 520g, bükkfa /fag



FESTA®



GUMIKALAPÁCS FA NYÉL  
CIOCAN CAUCIUC



19251 Ø 55 mm 400 g  
19252 Ø 65 mm 700 g  
19253 Ø 90 mm 1300 g



GUMIKALAPÁCS FA NYÉL  
CIOCAN CAUCIUC



Bükkfa nyél - cseh termék  
/ maner de fag - Fabricat in Cehia

19245 Ø 50mm, 0,4kg  
19246 Ø 60mm, 0,8kg  
19247 Ø 70mm, 1kg  
19248 Ø 95mm, 2kg  
19249 Ø 115mm, 3kg



FESTA®

GUMIKALAPÁCS, FEHÉR  
CIOCAN CAUCIUC ALB



19294 Ø 65 mm  
19295 Ø 90 mm



GUMI KALAPÁCS FEKETE-FEHÉR  
CIOCAN CAUCIUC



19254 Ø 65 mm



GUMIKALAPÁCS FA NYÉL  
CIOCAN CAUCIUC



19270 Ø 55 mm  
19271 Ø 65 mm  
19272 Ø 90 mm



GUMI KALAPÁCS  
CIOCAN CAUCIUC



19255 Ø 55 mm  
19265 Ø 65 mm  
19290 Ø 90 mm



SÁRGARÉZ KALAPÁCS  
CIOCAN CAP BRONZ

19210 Ø 30 mm, 0,5 kg



6

DOMBORÍTÓ KALAPÁCS  
CIOCAN SILICON

19297 Ø 35 mm



48

SZEKERCE  
TOPOR TAMPLARI

FESTA®

Körék / pana circulara  
kõris nyél - cseh termék  
/ Coada Frasin - Fabricat in Cehia

19340 700 g



1

FEJSZE  
TOPOR

FESTA®

DIN 5131  
DIN 7294  
Körék / pana circulara  
kõris nyél - cseh termék  
/ Coada Frasin - Fabricat in Cehia

19380	600 g	24	19384	1400 g	12
19381	800 g	24	19385	1600 g	12
19382	1000 g	24	19387	2000 g	10
19383	1250 g	12			

HASÍTÓ FEJSZE  
TOPOR

FESTA®

DIN 5129  
Körék / pana circulara  
kõris nyél - cseh termék  
/ Coada Frasin - Fabricat in Cehia19389 3000 g  
19388 4000 g

6

4

HASÍTÓ FEJSZE ÉKES  
TOPOR

FESTA®

DIN 7294  
Körék / pana circulara  
kõris nyél - cseh termék  
/ Coada Frasin - Fabricat in Cehia

19391 2000 g



12

FEJSZE ÜVEGSZÁLAS NYÉL  
TOPOR CU MANER FIBRA STICLA

19341	600 g	24	19345	1500 g	6
19342	800 g	24	19346	1800 g	6
19343	1000 g	12	19347	2000 g	6
19344	1250 g	12			

FEJSZE  
TOPOR SCURT

Körék / pana circulara

19306	600 g	24
19308	800 g	24
19310	1000 g	24
19312	1250 g	12
19314	1500 g	12

NYÉL  
MÁNER

61242	30 cm	25	61246	60 cm	25
61243	35 cm	25	61247	70 cm	10
61244	40 cm	25	61248	80 cm	10
61245	50 cm	25	61249	90 cm	10
			61239	90 cm	10

CAMPING FEJSZE  
TOPOR CAMP



FESTA®

19301 500 g



FEJSZE ÜVEGSZÁLAS NYÉL  
TOPOR CU MANER FIBRA STICLA



FESTA®

19326	600 g	24	19333	1400 g	6
19328	800 g	24	19335	1600 g	6
19330	1000 g	12	19337	2000 g	6
19332	1250 g	12			

HASÍTÓ FEJSZE  
TOPOR



FESTA®

19370 3000 g  
19371 4000 g



HASÍTÓ FEJSZE  
TOPOR



FESTA®

19392 1200 g



HASÍTÓ FEJSZE  
TOPOR



FESTA®

19390 2000 g



FEJSZE  
TOPOR



Black Eagle

19353	550 g	1	19357	1800 g	1
19354	600 g	1	19360	2700 g	1
19356	1200 g	1		ŠTÍPACÍ	1

HASÍTÓ ÉK  
DALTA PANA



19394 1000 g  
19395 2000 g  
19396 3000 g

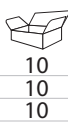

HASÍTÓ ÉK  
DALTA PANA



19397 2000 g  
NEW 19465 2500 g



ŠTÍPACÍ KLÍN ČTYŘRAMENNÝ  
SPLITTING WEDGE FOUR-SPOKE

NEW



19469 2500 g



ROZEVÍRACÍ KLÍN NYLONOVÝ  
OPENING WEDGE

NEW



19462	175 x 65 x 20 mm	10
19463	230 x 70 x 30 mm	10
19464	240 x 75 x 40 mm	10



**OVÁLNÉ PÁČIDLO**  
 OVAL PULLER

<b>19425</b>	600 mm	6
<b>19426</b>	800 mm	6
<b>19427</b>	1000 mm	6

**PAJSZER**  
 RANGA

FESTA®



<b>19416</b>	600 mm, Ø 16 mm	4
<b>19422</b>	800 mm, Ø 16 mm	1
<b>19421</b>	1000 mm, Ø 18 mm	1

**PAJSZER**  
 RANGA

Zbirovia



<b>19413</b>	400 mm	Ø 17 mm	4
<b>19414</b>	500 mm	Ø 17 mm	1
<b>19417</b>	700 mm	Ø 19 mm	1

**SZÖGHÚZÓ**  
 RANGA CU EXTRACTOR CUIE

<b>19415</b>	300 mm, Ø 15 mm	6
--------------	-----------------	---

**SZERZSÁMNYÉL ÉK, KÚPOS**  
 PANA CONICA

<b>19430</b>	6mm	10
<b>19431</b>	8mm	10
<b>19432</b>	10mm	10
<b>19433</b>	12mm	10
<b>19434</b>	14mm	10
<b>19435</b>	16mm	10

**ÉK**  
 PANA OTEL

<b>19440</b>	úzký/narrow	10
<b>19441</b>	střední/middle	10
<b>19442</b>	široký/wide	10
<b>19443</b>	široký S/wide S	10

**BÁDOGOS KÉSZLET**  
 KIT REPARATIE

<b>19110</b>	7 db/buc	5
--------------	----------	---

**ÉK**  
 PANA OTEL

<b>19398</b>	20 x 25 x 5 · 3 db/buc	1
<b>19399</b>	30 x 40 x 5 · 3 db/buc	1

FAVÉSŐ  
DALTI

FESTA®



CrV



19490	6 mm / 275 mm	1
19491	8 mm / 275 mm	1
NEW 19492	10 mm / 275 mm	1
19493	12 mm / 275 mm	1
19494	14 mm / 275 mm	1
NEW 19495	16 mm / 275 mm	1
19496	18 mm / 280 mm	1
19497	20 mm / 280 mm	1
NEW 19498	22 mm / 280 mm	1
19499	25 mm / 280 mm	1
19501	32 mm / 290 mm	1
19502	38 mm / 290 mm	1

FFAVÉSŐ KLT. FENŐKŐVEL  
SET DALTI PENTRU LEMN

FESTA®



CrV



19451 5 db/buc

10

FAVÉSŐ KLT.  
SET DALTI PENTRU LEMN

FESTA®



CrV



19457 6, 12, 19, 25 mm

10

FAVÉSŐ KLT.  
SET DALTI PENTRU LEMN



HOBBY



19450 8, 12, 19, 25 mm

5

FAVÉSŐ KLT.  
SET DALTI PENTRU LEMN



HOBBY



19455 8, 12, 19, 25 mm

30

FAVÉSŐ KLT.  
SET DALTI PENTRU  
LEMN



19459 12 db/buc

5

CIPÉSZÁR  
SULĂ



CrV



13287 220 mm

1

PROFI RÁÜTŐS TŰZŐGÉP  
CIOCAN CAPSE PROFÍ



FESTA®

6-10mm  
23960-23962



10

23922

TŰZŐGÉP PROFÍ  
CAPSATOR PROFÍ

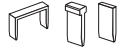

FESTA®

6-14mm  
23960-23964

14mm  
23966

14mm  
23967



12

23923 3 v 1

TŰZŐGÉP PROFÍ  
CAPSATOR PROFÍ



FESTA®

53/4-10mm  
23904-23910, 23760-23763



80

23926 4-10 mm

TŰZŐGÉP ERŐSZABÁLYOZÓS  
CAPSATOR REGLABIL

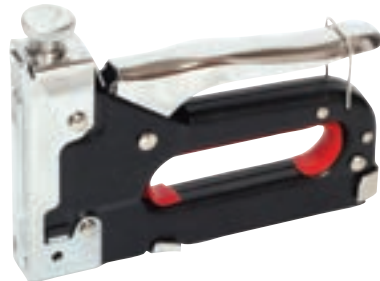

FESTA®

53/4-14mm  
23760-23765, 23904-23914



20

23800 4 - 14 mm

TŰZŐGÉPKAPOCS  
CAPSE

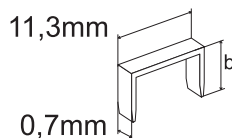

23904	□ b=4 mm /1000 db/buc	200
23906	□ b=6 mm /1000 db/buc	200
23908	□ b=8 mm /1000 db/buc	200
23910	□ b=10 mm /1000 db/buc	200
23912	□ b=12 mm /1000 db/buc	200
23914	□ b=14 mm /1000 db/buc	200

TŰZŐGÉP PROFÍ  
CAPSATOR PROFÍ



FESTA®

6-14mm  
23960-23964

12mm  
23965

14mm  
23966

14mm  
23967



12

23924 4 v 1

TŰZŐGÉP PROFÍ  
CAPSATOR PROFÍ



FESTA®

53/4-14mm  
23904-23914, 23760-23765



20

23925 4-14 mm

TŰZŐGÉP PROFÍ  
CAPSATOR PROFÍ



FESTA®

53/4-8mm  
23760-23762, 23904-23908



25

23804 4 - 8 mm

FESTA®

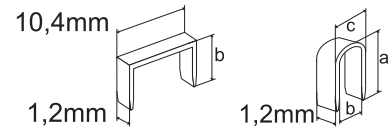

23960	b=6mm, 1000 db/buc	100
23961	b=8mm, 1000 db/buc	100
23962	b=10mm, 1000 db/buc	50
23963	b=12mm, 1000 db/buc	100
23964	b=14mm, 1000 db/buc	100
23965	a=12mm, b=6,5mm, c=7,5mm, 1000 TW	100
23966	14 mm/1000	100
23967	14 mm/1000	100

TÚZŐGÉP PROFI  
CAPSATOR PROFI



TACWISE

53/4-8mm  
23760-23762, 23904-23908



1

23750 Z1-53

TÚZŐGÉP PROFI  
CAPSATOR PROFI



TACWISE

53/4-8mm  
23760-23762, 23904-23908



1

23751 Z1-53L

TÚZŐGÉP PROFI  
CAPSATOR PROFI



TACWISE

53/6-14mm  
23761-23764, 23906-23914



1

23752 Z3-53

TÚZŐGÉP PROFI  
CAPSATOR PROFI

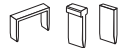

TACWISE

53/6-14mm  
23761-23764, 23906-23914



1

23753 Z3-13L

TÚZŐGÉPKAPOCS CAPSE (TYPE 53)

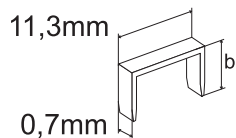

TACWISE



23760	b=4 mm	2000ks/ pcs	25
23761	b=6 mm	2000ks/ pcs	25
23762	b=8 mm	2000ks/ pcs	25
23763	b=10 mm	2000ks/ pcs	25
23764	b=12 mm	2000ks/ pcs	25



PILLANATSZORÍTÓ  
DISPOZITIV PRINDERE

FESTA®

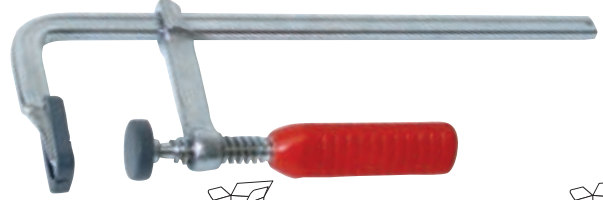

23670	150 mm x 105 mm	1
23671	200 mm x 105 mm	1
23672	250 mm x 105 mm	1
23673	300 mm x 105 mm	1
23674	350 mm x 105 mm	1
23675	400 mm x 175 mm	1
23676	500 mm x 175 mm	1
23677	600 mm x 175 mm	1
23678	700 mm x 175 mm	1
23679	800 mm x 175 mm	1
23680	1000 mm x 175 mm	1
23681	1250 mm x 175 mm	1
23682	1500 mm x 175 mm	1
23683	1750 mm x 175 mm	1
23684	2000 mm x 175 mm	1
23685	2200 mm x 175 mm	1

PILLANATSZORÍTÓ  
DISPOZITIV PRINDERE

23640	160x80 mm	20	23644	300x100 mm	10
23641	200x80 mm	20	23645	600x100 mm	10
23642	250x80 mm	20	23646	800x100 mm	10
23643	300x80 mm	20	23647	1000x100 mm	10

PILLANATSZORÍTÓ  
DISPOZITIV PRINDERE

23506	300 x 120 mm	10
23507	500 x 120 mm	10
23508	800 x 120 mm	6

DIN 5117

PILLANATSZORÍTÓ  
DISPOZITIV PRINDERE

23515	150 x 50 mm	50
23520	200 x 50 mm	50
23525	250 x 50 mm	50
23530	300 x 50 mm	50
23531	300 x 120 mm	20
23551	500 x 120 mm	10

PILLANATSZORÍTÓ  
DISPOZITIV PRINDERE

23585	150 mm	6
23587	300 mm	6
23589	450 mm	6
23591	600 mm	6

SZORÍTÓ  
DISPOZITIV PRINDERE

FESTA®



23625	8"/ 200 mm	6	23630	24"/ 600 mm	6
23626	12"/ 300 mm	6	23632	30"/ 760 mm	12
23628	18"/ 450 mm	6			

G - SZORÍTÓ KÉSZLET  
SET DISPOZITIVE PRINDERE

23620	2,5 cm, 5 cm, 7,5 cm	10
-------	----------------------	----

HOBBY

RACS NIS SZORÍTÓ  
CLEME LEMN

23605	9" / 230 mm	arasz 80mm	6
-------	-------------	------------	---

MŰANYAG CSIPESZ  
DISPOZITIV PRINDERE

23600	4"	arasz 40mm	12
23601	6"	arasz 50mm	12
23602	9"	arasz 80mm	48

SATU FORGATHATÓ  
MENGHINA  
CU BAZA  
MOBILA



<b>23415</b>	100 mm	4
<b>23416</b>	125 mm	4
<b>23417</b>	150 mm	2

SATU  
MENGHINA



<b>23410</b>	100 mm	4
<b>23411</b>	125 mm	4
<b>23412</b>	150 mm	2

ASZTALI SATU,  
FORGATHATÓ  
MINI MENGHINA  
CU BAZA ROTATIVA



<b>23407</b>	65 mm	10
--------------	-------	----

GÉPI SATU  
MENGHINA GAURIT



<b>23400</b>	18/80 mm	10
<b>23401</b>	22/100 mm	10
<b>23402</b>	24/125 mm	5

ASZTALI SATU, FORGATHATÓ 90°  
MINI MENGHINA CU BAZA 90°

NEW



<b>23420</b>	90° ↔ 65 mm	24
--------------	-------------	----

ASZTALI SATU, FORGATHATÓ 360°  
MINI MENGHINA CU BAZA  
ROTATIVA 360°



<b>23406</b>	ALU	24
--------------	-----	----

MUNKAPAD  
MASA LUCRU REGLABILA



<b>23660</b>	1
--------------	---

MUNKAPAD  
MASA LUCRU REGLABILA

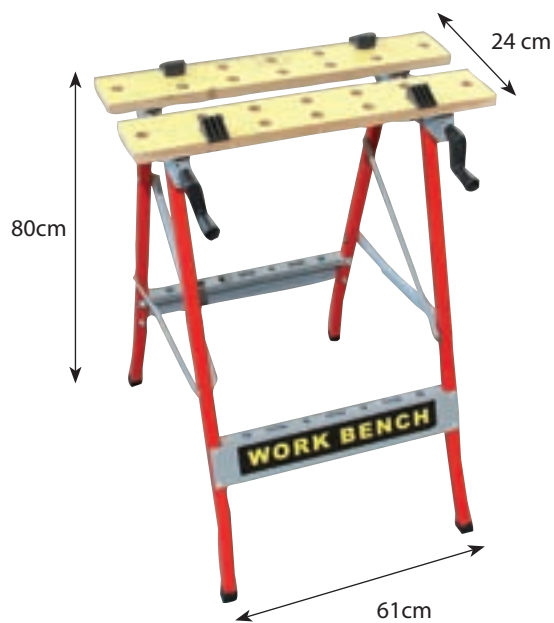

<b>23650</b>	1
--------------	---

POPSZEGECS FOGÓ FORDÍTHATÓ FEJSEL  
DISPOZITIV PENTRU NITUIT

acél, ALU  
otel, aluminiu

Ø 2,4 mm  
Ø 3,2 mm  
Ø 4,0 mm  
Ø 4,8 mm



24006 250 mm



POPSZEGECS FOGÓ  
DISPOZITIV PENTRU NITUIT

acél, rozsdamentesacél, ALU, réz  
otel, otel inoxidabil, aluminiu, cupru

Ø 2,4 mm  
Ø 3,2 mm  
Ø 4,0 mm  
Ø 4,8 mm

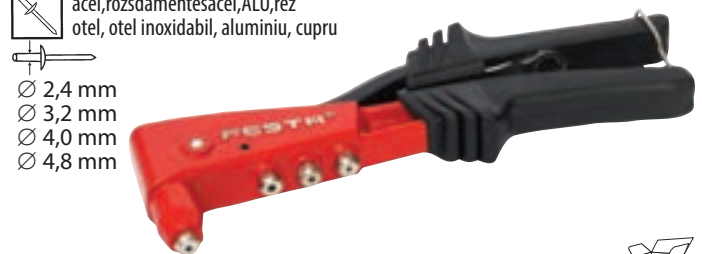

24010 250 mm



POPSZEGECS FOGÓ  
DISPOZITIV PENTRU NITUIT

acél, ALU  
otel, aluminiu

Ø 2,4 mm  
Ø 3,0 mm  
Ø 3,2 mm  
Ø 4,0 mm  
Ø 4,8 mm



24017 280 mm



POPSZEGECS FOGÓ  
DISPOZITIV PENTRU NITUIT

acél, rozsdamentesacél, ALU, réz  
otel, otel inoxidabil, aluminiu, cupru

Ø 2,4 mm  
Ø 3,2 mm  
Ø 4,0 mm  
Ø 4,8 mm  
Ø 6,4 mm



24015 530 mm



POPSZEGECS FOGÓ  
DISPOZITIV PENTRU NITUIT



24030



POPSZEGECS FOGÓ - ÁLLÍTHATÓ  
DISPOZITIV PENTRU NITUIT

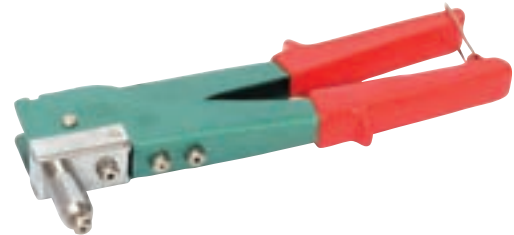

24002 260 mm



POPSZEGECS FOGÓ FORDÍTHATÓ FEJSEL  
DISPOZITIV PENTRU NITUIT



24020



POPSZEGECS FOGÓ  
DISPOZITIV PENTRU NITUIT



24001



POPSZEGECS FOGÓ + SZEGECSEK  
SET DISPOZITIV PENTRU NITUIT



24005



POPSZEGECS FOGÓ  
DISPOZITIV PENTRU NITUIT



24000



▼ ÖSSZEKAPCSOLÓ FOGÓ PROFILOKRA  
CLESTE PENTRU CONECTARE PROFILE



**17187** 350 mm



12

▼ SZEGECSELŐ PROFILOKRA  
DISPOZITIV DE NITUIT PENTRU PROFILE



**17189** 255 mm



12

▼ ÖSSZEKAPCSOLÓ FOGÓ PROFILOKRA  
CLESTE PENTRU CONECTARE PROFILE



**17188** 250 mm



12

▼ POPSZEGECS  
NITURI ALUMINIU



**ALU**



<b>23970</b>	3,2 x 6 mm	50 db/buc	200
<b>23971</b>	3,2 x 8 mm	50 db/buc	200
<b>23972</b>	3,2 x 10 mm	50 db/buc	200
<b>23973</b>	3,2 x 12 mm	50 db/buc	200
<b>23974</b>	3,2 x 14 mm	50 db/buc	200
<b>23975</b>	4,0 x 6 mm	50 db/buc	200
<b>23976</b>	4,0 x 8 mm	50 db/buc	200
<b>23977</b>	4,0 x 10 mm	50 db/buc	200
<b>23978</b>	4,0 x 12 mm	50 db/buc	150
<b>23979</b>	4,0 x 14 mm	50 db/buc	150
<b>23985</b>	4,8 x 6 mm	50 db/buc	100
<b>23986</b>	4,8 x 8 mm	50 db/buc	100
<b>23987</b>	4,8 x 10 mm	50 db/buc	100
<b>23988</b>	4,8 x 12 mm	50 db/buc	100
<b>23989</b>	4,8 x 14 mm	50 db/buc	100

**RUTILELEKTRÓD**  
**ELECTROD RUTILIC**

<b>70021</b>	∅ 2,0 x 300mm - 10 ks/pcs	20
<b>70026</b>	∅ 2,5 x 300mm - 10 ks/pcs	20
<b>70033</b>	∅ 3,2 x 350mm - 10 ks/pcs	10
<b>70020</b>	∅ 2,0 x 300 mm - 2,5 kg	8
<b>70025</b>	∅ 2,5 x 300 mm - 2,5 kg	8
<b>70032</b>	∅ 3,2 x 350 mm - 5 kg	4

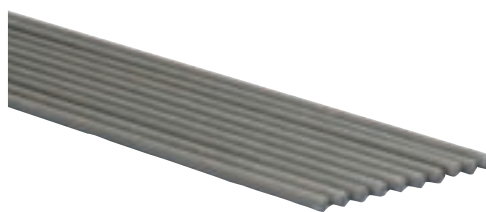
 Certifikát  
 Certificare
 
**BASICELEKTRÓD**  
**ELECTROD BASIC**

<b>70035</b>	2,5 kg	∅2,5x300mm	8
<b>70036</b>	10 ks/pcs	∅2,5x300mm	20
<b>70037</b>	5 kg	∅3,2x350mm	5
<b>70038</b>	10 ks/pcs	∅3,2x350mm	10

 Certifikát  
 Certificare
 
**ELEKTRÓDA FOGÓ**  
**CLESTE SUDURA**

**70070** 300 A

 50

**TEST FOGÓ**  
**CLESTE SUDURA**

**70075** 300 A

 100

**HEGESZTŐPAJZS ÖNSÖTÉTEDŐ**  
**MASCA SUDURA CU VIZOR SPECIAL**

**70060** 2x AA elem / 2x AA baterie

 4

**HEGESZTŐPAJZS ÖNSÖTÉTEDŐ CARBON**  
**MASCA SUDURA CU VIZOR SPECIAL CARBON**

**70063** 2x AA elem / 2x AA baterie

 4

**HEGESZTŐPAJZS PASSZÍV**  
**CASCA SUDURA**

**70061** UV/IR protection, shade 7-15

 DIN 11  

 4

**HEGESZTŐPAJZS ÜVEG**  
**STICLA OCHELARI SUDURA**

**70065** 2 ks/pcs set, 113 x 80 mm

 20

**HEGESZTŐSZEMÜVEG**  
**OCHELARI SUDURA**

**70062**

 1

**HEGESZTŐ KALAPÁCS**  
**CIOCAN SUDURA**

**19115** 300g

*Zbirovia*

 10

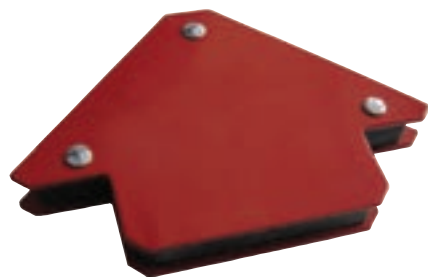
SAROKMÁGNES  
MAGNET UNGHIULAR

**70090** 85 x 85 mm · 90°, 45°, 135°

10

SAROKMÁGNES  
MAGNET UNGHIULAR

**70093** 95 x 64 mm · 105°, 125°, 140°

10

**70094** 120 x 90 mm · 105°, 125°, 135°

6

**70095** 137 x 110 mm · 105°, 125°, 140°

6

SAROKMÁGNES  
MAGNET UNGHIULAR

FESTA®



**70096** 150 x 150 x 38 mm · 90°

10

SAROKMÁGNES  
MAGNET UNGHIULAR

**70091** 95 x 109 x 25 mm · 90°, 135°, 90°

10

**70092** 130 x 150 x 32 mm · 90°, 135°, 90°

5

MENETESSZÁR  
TIJA FILETATA

Szilárdsági osztály - fok  
tarie 4.8  
**4.8**  
DIN 975



<b>55041</b>	M4, 1m	200
<b>55051</b>	M5, 1m	150
<b>55061</b>	M6, 1m	100
<b>55081</b>	M8, 1m	50
<b>55101</b>	M10, 1m	25
<b>55121</b>	M12, 1m	20
<b>55141</b>	M14, 1m	15

<b>55161</b>	M16, 1m	15
<b>55181</b>	M18, 1m	10
<b>55201</b>	M20, 1m	10
<b>55221</b>	M22, 1m	5
<b>55241</b>	M24, 1m	5
<b>55301</b>	M30, 1m	5

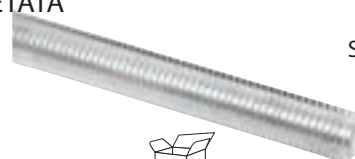
MENETESSZÁR  
TIJA FILETATA

Szilárdsági osztály - fok  
tarie 4.8  
**4.8**  
DIN 975



<b>55040</b>	M4, 1m	200
<b>55050</b>	M5, 1m	150
<b>55060</b>	M6, 1m	100
<b>55080</b>	M8, 1m	50
<b>55100</b>	M10, 1m	25
<b>55120</b>	M12, 1m	20
<b>55140</b>	M14, 1m	15

<b>55160</b>	M16, 1m	15
<b>55180</b>	M18, 1m	10
<b>55200</b>	M20, 1m	10
<b>55220</b>	M22, 1m	5
<b>55240</b>	M24, 1m	5
<b>55300</b>	M30, 1m	5

ALÁTÉT DIN 440R ZN  
SAIBA DIN 440R ZN

Zn



<b>55330</b>	M4 100db/buc	1
<b>55331</b>	M5 100db/buc	1
<b>55332</b>	M6 100db/buc	1
<b>55333</b>	M8 100db/buc	1
<b>55334</b>	M10 100db/buc	1
<b>55335</b>	M12 100db/buc	1
<b>55336</b>	M14 100db/buc	1

<b>55337</b>	M16 100db/buc	1
<b>55338</b>	M18 100db/buc	1
<b>55339</b>	M20 10db/buc	1
<b>55340</b>	M22 10db/buc	1
<b>55341</b>	M24 10db/buc	1
<b>55342</b>	M30 10db/bc	1

ALÁTÉT DIN 125A Zn  
SAIBA DIN 125A Zn

<b>55370</b>	M4 100db/buc	1
<b>55371</b>	M5 100db/buc	1
<b>55372</b>	M6 100db/buc	1
<b>55373</b>	M8 100db/buc	1
<b>55374</b>	M10 100db/buc	1
<b>55375</b>	M12 100db/buc	1
<b>55376</b>	M14 100db/buc	1

<b>55377</b>	M16 100db/buc	1
<b>55378</b>	M18 100db/buc	1
<b>55379</b>	M20 10db/buc	1
<b>55380</b>	M22 10db/buc	1
<b>55381</b>	M24 10db/buc	1
<b>55382</b>	M30 10db/buc	1

HATLAPÚ ANYA DIN 934 Zn  
PIULITE HEXAGONALE DIN 934 Zn

Szilárdsági osztály - fok  
tarie 4.8

DIN 975

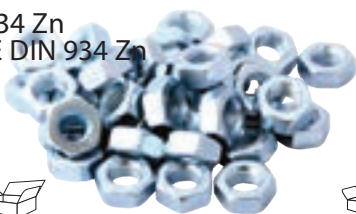

<b>55350</b>	M4 100db/buc	1
<b>55351</b>	M5 100db/buc	1
<b>55352</b>	M6 100db/buc	1
<b>55353</b>	M8 100db/buc	1
<b>55354</b>	M10 100db/buc	1
<b>55355</b>	M12 100db/buc	1
<b>55356</b>	M14 100db/buc	1

<b>55357</b>	M16 100db/buc	1
<b>55358</b>	M18 100db/buc	1
<b>55359</b>	M20 10db/buc	1
<b>55360</b>	M22 10db/buc	1
<b>55361</b>	M24 10db/buc	1
<b>55362</b>	M30 10db/buc	1

KOMPRESSZOR KLT.  
SET COMPRESOR

FESTA®



48001 5 db/buc



KOMPRESSZOR KLT.  
SET COMPRESOR

FESTA®

NEW



48002 3 db/buc



LEVEGŐPISZTOLY RÖVID  
PISTOL AER SCURT

FESTA®

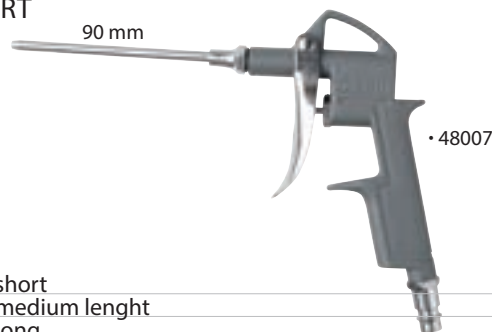

• 48007

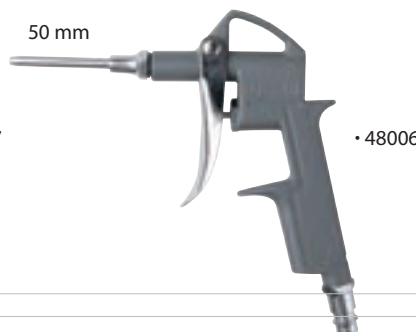

• 48006



• 48005

48005 krátka / short  
48006 střední / medium lenght  
48007 dlouhá / long



LEVEGŐPISZTOLY NYOMÁSMÉRŐVEL  
PISTOL AER CU DUZA

FESTA®



48010



OLAJPISZTOLY, LEVEGŐS  
PISTOL VOPSEA CU RECIPIENT

FESTA®



48015



SZORÓPISZTOLY, LEVEGŐS,  
FELSŐ TARTÁLY  
PISTOL VOPSEA - SUS

FESTA®



48020



SZORÓPISZTOLY, LEVEGŐS,  
FELSŐ TARTÁLY  
PISTOL VOPSEA - PLASTIC

FESTA®



48021 fúvóka / duza Ø 1,7 mm  
48047



1

▼ SZORÓPISZTOLY,  
LEVEGŐS,  
FELSŐ TARTÁLY  
PISTOL VOPSEA -  
ALUMINIU

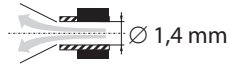

FESTA®

48022  
48046 fúvóka /duză Ø 1,5 mm



▼ ÜREGELŐ PISZTOLY, LEVEGŐS  
PISTOL



FESTA®

48036 10 db/buc



▼ ALVÁZFÚJÓ PISZTOLY,  
LEVEGŐS  
PISTOL VOPSEA

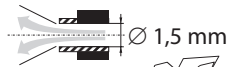

FESTA®

48030



▼ ALVÁZFÚJÓ PISZTOLY,  
LEVEGŐS  
PISTOL VOPSEA

NEW



FESTA®

48038 1000ml  
48039 Hadice k pískovací pistoli 1m



20  
20

▼ LÉGTÖMLŐ CSATLAKOZÓKKAL  
FURTUN SPIRALAT CONECTORI INCLUSI

FESTA®



48040 5 m, 8 atm  
48041 10 m, 8 atm  
48042 15 m, 8 atm

50  
20  
20

▼ TARTALÉK FÚVOKA  
DUZE DE REZERVĂ

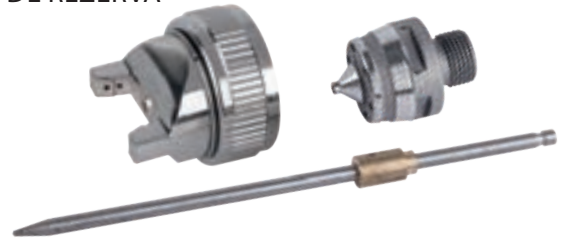

48046 fúvóka /duză Ø 1,5 mm pentru/ 48022  
48047 fúvóka /duză Ø 1,7 mm pentru/ 48021

1  
1



**TABEL DIMENSIUNI FILETE DE ȚEAVĂ WHITWORTH  
TABLE OF WHITWORTHS PIPE THREADS**

Mărime filet G în țoli/ Size of threads in inch	Ø exterior max. filetelui în mm/ Max. outer Ø of threads mm
1/8	9,728
1/4	13,157
3/8	16,662
1/2	20,955
3/4	26,441
1	33,249

**KÖZCSAVAR  
ADAPTOR DUBLU**

<b>48050</b>	1/4" külső menetel / ext. x 1/4" külső menetel / ext.	1
<b>48051</b>	1/4" külső menetel / ext. x 3/8" külső menetel / ext.	1

**SZŰKÍTŐ  
ADAPTER**

<b>48054</b>	3/8" külső menetel / ext. x 1/4" belső menetel / int.	1
<b>48055</b>	1/2" külső menetel / ext. x 3/8" belső menetel / int.	1
<b>48056</b>	3/8" külső menetel / ext. x 1/2" belső menetel / int.	1
<b>48057</b>	1/4" külső menetel / ext. x 3/8" belső menetel / int.	1

**GYORSCSATLAKOZÓ  
CONECTOR FURTUN**

<b>48070</b>	1/4" - 6 mm	1
<b>48071</b>	3/8" - 9 mm	1
<b>48072</b>	1/2" - 13 mm	1

**GYORSCSATLAKOZÓ KÜLSŐ MENETEL  
CONECTOR FURTUN FILET EXTERIOR**

<b>48075</b>	1/4" külső menetel / ext.	1
<b>48076</b>	3/8" külső menetel / ext.	1
<b>48077</b>	1/2" külső menetel / ext.	1
<b>48095</b>	1/4" belső menetel / int.	1
<b>48096</b>	3/8" belső menetel / int.	1
<b>48097</b>	1/2" belső menetel / int.	1

**CSAPCSATLAKOZÓ  
CONECTOR FURTUN FILET EXTERIOR**

<b>48080</b>	1/4" külső menetel / ext.	1
<b>48081</b>	3/8" külső menetel / ext.	1
<b>48090</b>	3/8" belső menetel / int.	1
<b>48091</b>	1/4" belső menetel / int.	1

**TÖMLŐBILINCS  
RACORD**

<b>48085</b>	1/4" - 6 mm	1
<b>48086</b>	3/8" - 9 mm	1
<b>48087</b>	1/2" - 13 mm	1

**CSAPCSATLAKOZÓ  
ADAPTER**

<b>48060</b>	Ø 6 mm - 1/8" külső menetel / ext.	1
<b>48061</b>	Ø 6 mm - 1/4" külső menetel / ext.	1
<b>48062</b>	Ø 6 mm - 3/8" külső menetel / ext.	1
<b>48063</b>	Ø 9 mm - 1/4" külső menetel / ext.	1
<b>48064</b>	Ø 9 mm - 3/8" külső menetel / ext.	1
<b>48065</b>	Ø 13 mm - 1/4" külső menetel / ext.	1
<b>48066</b>	Ø 13 mm - 3/8" külső menetel / ext.	1
<b>48067</b>	Ø 6 mm - 3/8" belső menetel / int.	1
<b>48068</b>	Ø 9 mm - 3/8" belső menetel / int.	1
<b>48093</b>	Ø 6 mm - 1/4" belső menetel / int.	1
<b>48094</b>	Ø 9 mm - 1/4" belső menetel / int.	1

▼ PORMASZK  
MASCA PRAF



CE EN 149



**50500** FFP2 / fara valva  
**50501** FFP1 / fara valva

20  
1

▼ PORMASZK  
MASCA PRAF



CE EN 149



**50502** FFP1 / cu valva  
**50503** FFP2 / cu valva

1  
1

▼ VÉDŐSZEMÜVEG  
OCHELARI DE PROTECTIE



CE EN 166

**50510**

10

▼ VÉDŐSZEMÜVEG  
OCHELARI DE PROTECTIE



CE EN 166

**50511**

10

▼ VÉDŐSZEMÜVEG  
OCHELARI DE PROTECTIE



CE EN 170

**50512** Sötét/fumurii

10

▼ VÉDŐSZEMÜVEG  
OCHELARI DE PROTECTIE



CE EN 166

**50513**

10

▼ VÉDŐSZEMÜVEG  
OCHELARI DE PROTECTIE



CE EN 166

**50514**

10

▼ VÉDŐKESZTYŰ, ERŐSITETT  
MANUSA PIELÉ BOVINA



CE EN 388

**50518** méretű/dimensiuni 11"

12

▼ VÉDŐKESZTYŰ, ERŐSITETT, BÉLELT TENYÉR  
MANUSA PIELÉ BOVINA



CE EN 388

**50519** méretű/dimensiuni 10,5"

12

▼ HASÍTOTTBŐR KESZTYŰ  
MANUSI PIELÉ



CE EN 388

**50520** méretű/dimensiuni 10,5"

12

BŐRKESZTYŰ ERŐSÍTETT  
MANUSI PIELE CU PALMA RANFORSATA



CE EN 388



50521 méretű/dimensiuni 10,5"

12

BŐRKESZTYŰ ERŐSÍTETT THERMO BÉLÉSEL  
MANUSI PIELE PENTRU IARNA



CE EN 388



50523 méretű/dimensiuni 11"

12

PAMUTKESZTYŰ PVC PÖTTYÖKKEL  
MANUSI BUMBAC CU PUNCTE PVC



50524 méretű/dimensiuni 10"

12

PAMUTKESZTYŰ TELJESEN MÁRTOTT  
MANUSI PVC CU INSERTIE BUMBAC



CE EN 388



50525 méretű/dimensiuni 10" - 35cm

12

POLIÉSZTERKESZTYŰ PVC PÖTTYÖKKEL  
MANUSI POLIESTER CU PUNCTE PVC



50526 méretű/dimensiuni 10"

12

PAMUTKESZTYŰ FÉLIGMÁRTOTT  
MANUSI BUMBAC CU INVELIS LATEX



CE EN 388



50522 méretű/dimensiuni 10"

12

NYLON KESZTYŰ NITRIL ÁZTATÁS  
MANUSI NYLON CU INVELIS NITRIL



CE EN 388



50533 méretű/dimensiuni 10"

12

NYLON KESZTYŰ LATEX ÁZTATÁS  
MANUSI NYLON CU INVELIS SPUMA LATEX



CE EN 388



50537 méretű/dimensiuni 10"

12

NYLON KESZTYŰ NITRIL ÁZTATÁS PVC PÖTTYÖKKEL  
MANUSI NYLON CU INVELIS SPUMA NITRIL



CE EN 388



50539 PVC PÖTTYÖKKEL/cu puncte PVC, méretű/dimensiuni 10"

12

ACRYL TÉLIKESZTYŰ LATEX ERŐSÍTÉS  
MANUSA LATEX



CE EN 388



50529 méretű/dimensiuni 10"

1

▼ PAMUTKESZTYŰ  
MANUSI



<b>NEW</b>	<b>50557</b>	méretű/dimensiuni 7"	12
<b>NEW</b>	<b>50558</b>	méretű/dimensiuni 8"	12
	<b>50549</b>	méretű/dimensiuni 9"	12

▼ NYLON-KECSKEBŐR KESZTYŰ  
MANUSI PIELE CAPRA CU INSERTIE NYLO



	<b>50541</b>	méretű/dimensiuni 10"	12
	<b>50542</b>	méretű/dimensiuni 9"	12

▼ NYLON KESZTYŰ POLIURETÁN ÁZTATÁS  
MANUSI NYLON CU INVELIS POLIURETAN



CE EN 388



	<b>50527</b>	méretű/dimensiuni 10"	12
--	--------------	-----------------------	----

▼ HEGESZTŐ KESZTYŰ BŐR  
MANUSI PIELE PENTRU SUDURA



CE EN 388



	<b>50540</b>	méretű/dimensiuni 11"	12
--	--------------	-----------------------	----

▼ LATEX KESZTYŰ, EGYSZER HASZNÁLATOS  
MANUSI LATEX UNICA FOLOSINTA



	<b>50530</b>		10
--	--------------	--	----

▼ PAMUTKESZTYŰ PVC PÖTTYÖKKEL KERTÉSZ  
MANUSI BUMBAC CU PUNCTE PVC



	<b>50531</b>	méretű/dimensiuni 9"	12
--	--------------	----------------------	----

▼ NYLON-DISZNÓBŐR KESZTYŰK  
MANUSI PIELE PORC CU INSERTIE NYLON



	<b>50544</b>	méretű/dimensiuni 10"	12
--	--------------	-----------------------	----

▼ NYLON-KECSKEBŐR KESZTYŰ  
MANUSI PIELE CAPRA CU INSERTIE NYLON  
SI PALMA CU PERNE



	<b>50546</b>	méretű / dimensiuni 10	12
	<b>50547</b>	méretű / dimensiuni 11	12
	<b>50548</b>	méretű / dimensiuni 12	12

▼ ZÁSTĚRA NA SVAŘOVÁNÍ  
APRON FOR WELDING



	<b>50555</b>	BŐR/PIELE	10
--	--------------	-----------	----

FÜLTOK  
ANTIFOANE



CE EN 352



50563 27dB

FÜLTOK PÁRNÁZOTT FEJRÉSSZEL  
ANTIFOANE



CE EN 352



50564 27dB

ARCVÉDŐ PLEXI  
MASCA PE CU ECRAN PROTECTOR



CE EN 166



50556

VÉDŐ BUKÓISAK CLIMAX  
CASCA PROTECTIE CLIMAX



CE EN 397



50550	kék/albastru	60
50551	piros/roşu	60
50553	fehér/alb	60
50554	sárga/galben	60

FÉNYVISSZAVERÓ MELLÉNY  
REFLECTORIZANTE VEST



CE EN 471



50570	narancs/portocaliu	100
50571	sárga/galben	100

100
100

▼ FÜLDUGÓ  
DOPURI PROTECTIE URECHI



50560

▼ FÜLDUGÓ  
DOPURI PROTECTIE URECHI



50559

▼ TÉRDVÉDŐ  
GENUNCHIERE



FESTA®



37143 NYLON

▼ TÉRDVÉDŐ  
GENUNCHIERE



FESTA®



37144 GEL

▼ TÉRDVÉDŐ  
GENUNCHIERE



37141

▼ TÉRDVÉDŐ  
GENUNCHIERE



FESTA®



37142 KOMFORT

▼ TÉRDVÉDŐ  
GENUNCHIERE



37139 NEOPREN

▼ TÉRDVÉDŐ  
GENUNCHIERE



FESTA®



37140 GEL

▼ TÉRDVÉDŐ PAD, MOBIL  
CARUCIOR GENUCHI



37135



NYLON ÖV  
CENTURA NYLON

FESTA®



37310 120 x 6 cm



SZERSZÁM ÖV  
CENTURA

FESTA®



37311 14 részes / buzunare



TOK  
HUSA

FESTA®



37312 21 x 10 cm kapoccsal / agatatori  
37313 16 x 8,5 cm univerzális / universala



TOK  
HUSA

FESTA®



37314 25 x 15 cm kisebb szerszámoknak / pentru scule mici  
37315 30 x 18 cm akus szerszámoknak / pentru scule cu AKU



SZERSZÁMTOK  
SUPORT

FESTA®



37320 8 részes / buzunare, 30 x 25 cm  
37321 4 részes / buzunare, 35 x 30 cm



SZERSZÁMTÁSKA  
GEANTA SCULE

FESTA®



37330 61 x 27 x 40 cm



SZERSZÁMMELLÉNY  
JACHETA DE LUCRU

FESTA®



37350



ÁCS ÖVTÁSKA  
CUREA PENTRU UNELTE

FESTA®



37300 6 részes / buzunar  
37301 11 részes / buzunare



ÁCS ÖVTÁSKA  
CUREA PENTRU UNELTE

FESTA®



37302 6 részes / buzunar PROFIL  
37303 11 részes / buzunare PROFIL



ÖVTARTÓ  
AGATATORI

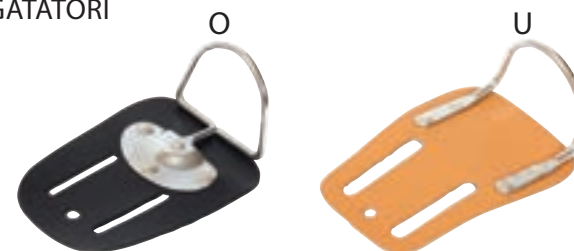

37308 O  
37309 U



# KDS®

Nagyon jóminőségű kések és tartós pengék  
Cuttere de inalta calitate si lame rezistente

## Japán KDS cég kései

Kitűnő ergonomikus markolat  
Minőségi teljesítményű és élettartamú borotva penge  
Legjobb anyagból készült borotvapenge  
Alacsony vágási ellenállás könnyű vágást tesz lehetővé

## Cuțite produse de compania japoneza KDS

excelenta ergonomie a manerelor  
lame durabile de inalta performanta  
lame din cele mai bune materiale  
rezistente pentru taiere joasa care permite taierea cu usurinta

### TÖRHEŐ PENGÉS KÉS CUTTER PROFESIONAL

**KDS®**

**16001** L15 18 mm + 2 pótpenge / lame  
**16011** LB10 pótpengék / lame rezerva



10

20

### TÖRHEŐ PENGÉS KÉS CUTTER PROFESIONAL

**KDS®**

**16002** LC405 18 mm + 1 penge / lame  
**16011** LB10 pótpengék / lame rezerva



25

20

### TÖRHEŐ PENGÉS KÉS CUTTER PROFESIONAL

**KDS®**

**16003** G11 18 mm + 2 pótpenge / lame  
**16012** GB10 pótpengék / lame rezerva



10

20

### TÖRHEŐ PENGÉS KÉS CUTTER PROFESIONAL

**KDS®**

**16004** H11 25 mm  
**16013** HB10 pótpengék / lame rezerva



10

10

### TÖRHEŐ PENGÉS KÉS CUTTER PROFESIONAL

**KDS®**

**16005** S14 9 mm + 2 pótpenge / lame  
**16010** SB10 pótpengék / lame rezerva



10

20

### TÖRHEŐ PENGÉS KÉS CUTTER PROFESIONAL

**KDS®**

**16006** D11 szike / lame + 16 pótpenge / lame  
**16014** DB48 pótpengék / lame rezerva



10

10

### TÖRHEŐ PENGÉS KÉS CUTTER PROFESIONAL

**KDS®**

**16008** L21 18 mm, 3 pótpenge / lame  
**16011** LB10 pótpengék / lame rezerva  
**16012** GB10 pótpengék / lame rezerva



10

20

20

### TÖRHEŐ PENGÉS KÉS CUTTER PROFESIONAL

**KDS®**

**16018** KDS/L18 18 mm + 2 pótpengék / lame rezerva



10

10



▼ TÖRHEŐ PENGÉS KÉS  
CUTTER PROFESIONAL

KDS®



16019 KDS/L19 18 mm + 2 pótpenge / lame



10

▼ TÖRHEŐ PENGÉS KÉS  
CUTTER PROFESIONAL

KDS®



16020 KDS/H12 25 mm



10

▼ KDS BEMUTATÓ  
ÁLLVÁNY  
STAND  
PROMOTIONAL KDS

KDS®



16998- Oszeny poločkami/  
Filled with  
16001, 16003, 16004,  
16005, 16006, 16008,  
16018, 16019, 16020,



16999 Reklamní stojan 1

16998 Reklamní stojan osazený/ Filled 1

▼ PÓT PENGÉK  
LAME REZERVA

KDS®



16010 SB10 9/0,38 mm/10 db/buc 20

16011 LB10 18/0,5 mm/10 db/buc 20

16012 GB10 18/0,6 mm/10 db/buc 20

16013 HB10 25/0,7 mm/10 db/buc 10

16014 DB48 szike készlet / set lame 10

▼ PÓT PENGÉK SPECIAL  
LAME REZERVA SPECIAL

KDS®

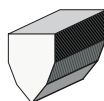

Speciális ötvözet / aliaj special  
Kétszeres fenés / dubla ascutire  
Emelt élettartalom / durata de viata ridicata  
Alacsony vágási ellenállás könnyű vágást tesz lehetővé / rezis-  
tenta mica la taiere care permite taierea cu usurinta



16016 LB10B 18/0,5 mm/10 db/buc 20

16017 HB10B 25/0,7 mm/10 db/buc 10

▼ TÖRHETŐ PENGÉS KÉS  
CUTTER PROFESIONAL

FESTA®

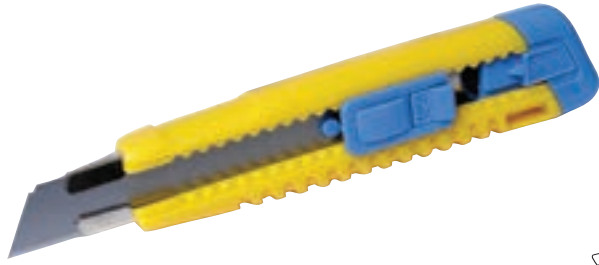

16100 L12 18 mm + 1 penge / lame



12

▼ TÖRHETŐ PENGÉS KÉS  
CUTTER PROFESIONAL

FESTA®



16105 L17 18 mm + 1 penge / lame



12

▼ TÖRHETŐ PENGÉS KÉS  
CUTTER PROFESIONAL

FESTA®

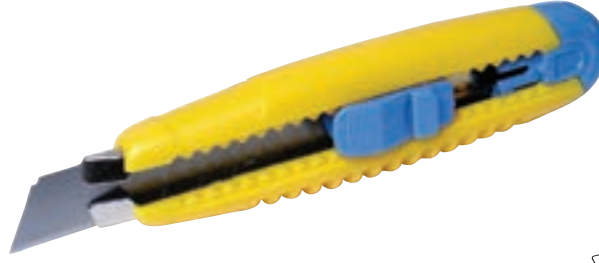

16110 L11 18 mm + 1 penge / lame



12

▼ TÖRHETŐ PENGÉS KÉS  
CUTTER PROFESIONAL

FESTA®



16115 L10 9 mm



24

▼ TÖRHETŐ PENGÉS KÉS  
CUTTER PROFESIONAL

FESTA®

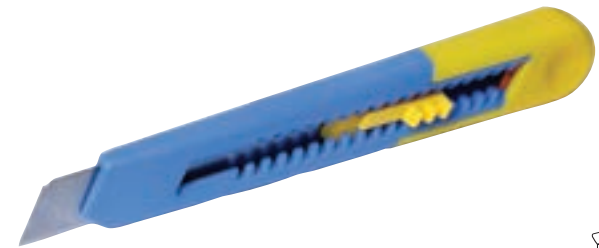

16120 L8 18 mm  
16125 L4 9 mm



24

24

▼ TÖRHETŐ PENGÉS KÉS  
CUTTER PROFESIONAL

FESTA®



16140 L22 18 mm



12

▼ TÖRHETŐ PENGÉS KÉS  
CUTTER PROFESIONAL

FESTA®



16130 L18 18 mm, 6 pótpenge / lame



12

▼ TÖRHETŐ PENGÉS KÉS  
CUTTER PROFESIONAL

FESTA®



16135 L20 25 mm + 5 pótpenge / lame



6

▼ TÖRHETŐ PENGÉS KÉS  
CUTTER PROFESIONAL

FESTA®



16144 L24 18 mm, Fém / metal



12

▼ TÖRHETŐ PENGÉS KÉS  
CUTTER PROFESIONAL

FESTA®



16145 L25 18 mm, Fém / metal



12

▼ TÖRHETŐ PENGÉS KÉS  
CUTTER PROFESIONAL

FESTA®



16090 18 mm, Fém /metal, 5 pótpenge / lame



12

▼ TÖRHETŐ PENGÉS KÉS  
CUTTER PROFESIONAL

FESTA®



16091 25 mm, Fém /metal, 5 pótpenge / lame



12

▼ TÖRHETŐ PENGÉS KÉS  
CUTTER PROFESIONAL

FESTA®



16146 18 mm



12

▼ TÖRHETŐ PENGÉS KÉS  
CUTTER PROFESIONAL

FESTA®



16147 25 mm



12

▼ TÖRHETŐ PENGÉS KÉS  
CUTTER PROFESIONAL

FESTA®



16029 18 mm, Fém /metal



25

▼ TÖRHETŐ PENGÉS KÉS  
CUTTER PROFESIONAL

FESTA®



16034 25 mm



12

▼ LINÓLEUM VÁGÓKÉS  
CUTTER TURBO

FESTA®



16037 + 5 pótpenge / lame



6

▼ DELFINKÉS PROFI  
CUTTER PROFI DELFIN

FESTA®



16033 NP110 + 1 penge / lame



5

▼ LINÓLEUM VÁGÓKÉS  
CUTTER

FESTA®



16035 Fém /metal, 5 pótpenge / lame



12

▼ VÁGÓKERÉK  
CUTTER ROATA

FESTA®



16040 Ø 45 mm + pótpenge / lame



12

▼ LINÓLEUM VÁGÓKÉS  
CUTTERE TURBO



FESTA®

16095 Fém /metal, 25 pótpenge / lame



1

▼ LINÓLEUM VÁGÓKÉS  
CUTTER DEBLOCARE RAPIDA



FESTA®

16038 25 mm, 5 pótpenge / lame



12

▼ LINÓLEUM VÁGÓKÉS  
CUTTER



16032 NP109



48

▼ SZÖNYEGPADLÓVÁGÓ KÉS,  
HORGAS CUTTER



pentru mochete sau linoleum

16041



12

▼ LINÓLEUM VÁGÓKÉS  
CUTTER



16030 NS107



24

▼ TÖRHEŐ PENGÉS KÉS  
CUTTER



16028 S201 18 mm



24

▼ TÖRHEŐ PENGÉS KÉS  
CUTTER

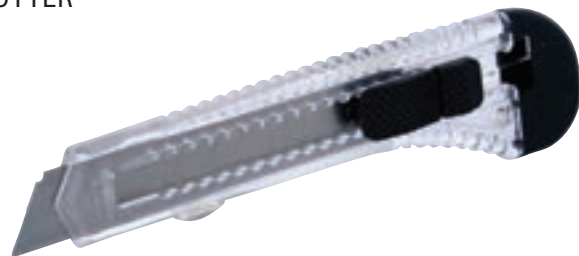

16024 P204 18 mm



60

▼ LINÓLEUM VÁGÓKÉS  
CUTTER



16031 NS107B



24

▼ TÖRHEŐ PENGÉS KÉS  
CUTTER



16026 P205 18 mm



30

▼ KÉS KLT.  
CUTTERE



16043 3 db/buc



24

▼ TÖRHETŐ PENGÉS KÉS  
CUTTER

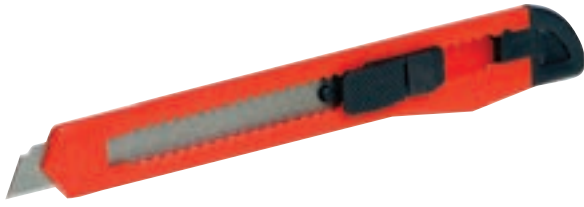

HOBBY



16021 P101 9 mm

60

▼ KÖRPENGÉS KÉS  
CUTTER PENTRU MOCHETA



Pótkerék / lama disc 16076



16036

12

▼ KÉS KLT.  
CUTTERE



HOBBY



16045 6 db/buc

144

▼ KÉS KLT.  
CUTTERE



HOBBY



16053 12 db/buc - 9 mm  
16055 12 db/buc - 18 mm

48

24

▼ KAPARÓ  
RASCHETA FEREAȘTRA



16051

24

▼ TÖRHETŐ PENGÉS KÉS  
CUTTER

FESTA®



INOX



16085 9 mm  
16086 18 mm

24

24

▼ TÖRHETŐ PENGÉS KÉS  
CUTTER PROFESIONAL

NEW



16141 18 mm 24 db/buc

24

▼ KÉS KLT.  
CUTTERE



HOBBY



16048 8 db/buc

96

▼ KAPARÓ  
RASCHETA FEREAȘTRA

FESTA®

NEW



16049  
16069 Náhradní čepel

24

1

▼ KAPARÓ  
RASCHETA FEREAȘTRA



HOBBY



16050 SF1501

24

MEGHOSSZABÍTOTT KAPARÓ  
RACLETA LUNGA PENTRU FERESTRE



16052	10 cm x 48 cm	6
16070	pót pengék / lame rezerva	25

PÓT PENGÉK  
LAME REZERVA

16080	S009	9/0,40 mm/10 db/buc	10
16060	S009	9/0,45 mm/10 db/buc	10

16065	B018	18/0,5 mm/10 db/buc	10
16068	B025	25/0,6 mm/10 db/buc	200

16067	B018H	18/0,5 mm/10 db/buc	20
-------	-------	---------------------	----

PÓT PENGÉK  
LAME REZERVA

16071	R001	/10db/buc	25
-------	------	-----------	----

16073	R002	/10db/buc	25
-------	------	-----------	----

PÓT PENGÉK  
LAME REZERVA

16072	R004	/10db/buc	24
-------	------	-----------	----

16075	R003	/10db/buc	24
-------	------	-----------	----

ÁSVÁNYGYAPOT, POLISZTIROL VÁGÓ  
KÉS  
CUTIT PENTRU IZOLATII



16199	48/35 cm	10
-------	----------	----

pentru vata minerala, polistiren

KÉSZLET MARÓGÉP ALKALMAZÁSA ÉS ELTÁVOLÍTÁSA  
SZILIKON  
SET DE SCREPERE PENTRU APLICAREA ȘI ÎNDEPĂRTAREA  
SILICON



16042	3 db/buc	24
-------	----------	----

PÓT PENGÉK  
LAME REZERVA



16078	18mm / 0,5mm / 10 db/buc	10
NEW 16077	18mm / 0,6mm / 10 db/buc	10

PÓT PENGÉK  
DISC DE REZERVA

16076	Pót pengék / Disc de rezerva	10
NEW 34316	Pót pengék / Disc de rezerva	10

PÓT PENGE  
LAME

16083	Pót penge / Lame	18 mm H	5 db/buc	50
NEW 16084	Pót penge / Lame	18 mm L	5 db/buc	50

KÉS ÁSVÁNYGYAPOTRA  
CUTTER PENTRU VATA



16198	44.5/33 cm	12
-------	------------	----

FESTA®  
Made in UK

FESTA®

FESTA®

FESTA®  
Made in UK

FESTA®

FESTA®

MŰSZAKI KÉS, ERŐSÍTETT PENGÉVEL, TOKKAL  
CUTIT TEHNIC



16230 21/10 cm

INOX



LINÓLEUM VÁGÓKÉS  
CUTTER PENTRU MOCHETE

FESTA®



16225 20/8,5 cm



KÉS  
BRICEAG

FESTA®



16211 20/8,5 cm

INOX



KÉS  
BRICEAG

FESTA®



16210 20,5/9 cm

INOX



KAPARÓ  
CUTTER PENTRU BENZI

FESTA®



16201 Ø 8-27 mm



KÉS  
BRICEAG

FESTA®



16212 15/3,2 cm

INOX



KÉS  
BRICEAG



16219 19/11 cm

INOX



KÉS  
BRICEAG



16218 18,5/10,5 cm

INOX



KÉS  
BRICEAG

FESTA®



16221 21 / 12 cm

INOX



KÉS  
BRICEAG

FESTA®



16220 18,5 / 11 cm

INOX



▼ KÉS  
BRICEAG



INOX



16223 18,5 / 10,5 cm ALU

24

▼ KÉS  
BRICEAG

FESTA®



INOX



16236 22,5/11 cm

24

▼ KÉS  
BRICEAG

FESTA®



INOX



16226 17,5/7 cm

24

▼ KÉS  
BRICEAG

FESTA®



INOX



16228 27/10,5 cm

24

▼ SZIKE, SZKALPEL  
SCALPELE



16281 13 db/buc

80

▼ KÉS  
BRICEAG

FESTA®



INOX



16222 20 / 12 cm

24

▼ KÉS  
BRICEAG

FESTA®



INOX



16235 17,5/8,5 cm

24

▼ KÉS  
BRICEAG



INOX



16224 17,5/7cm, 7 funkció/7 functii

24

▼ KÉS  
BRICEAG



16227 20,5/10 cm

24

▼ SZIKE, SZKALPEL  
SCALPELE



16280 6 db/buc

6



▼ SZIKE, SZKALPEL  
SCALPELE



16282 23 db/buc



24

▼ KÉS ÉS OLLÓ ÉLEZŐ  
UNEALTA ASCUTIT FOARFECI SI CUTITE



16990 Ø 50 mm



50

▼ KÉS ÉS OLLÓ ÉLEZŐ  
UNEALTA ACTUTIT FOARFECI SI CUTITE



16991



1

▼ KÉS ÉS OLLÓ ÉLEZŐ  
UNEALTA ACTUTIT FOARFECI SI CUTITE



45068



20

▼ KÉS ÉS OLLÓ ÉLEZŐ  
UNEALTA ACTUTIT FOARFECI SI CUTITE



45048



20

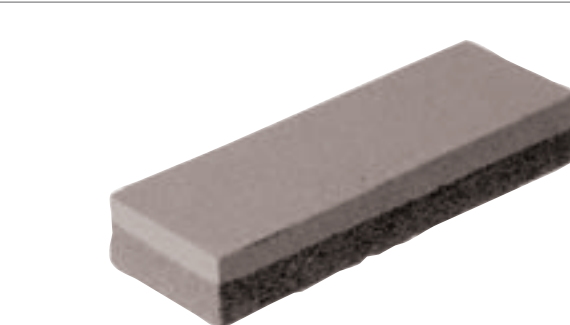

45046 205 x 15 mm



100

▼ PVC CSŐ VÁGÓ  
DISPOZITIV PENTRU TAIAT TEVI



**16300** Ø 3-32 mm  
**16310** pótpenge / Dispozitiv taiat tevi



10  
1

▼ PVC CSŐ VÁGÓ  
DISPOZITIV PENTRU TAIAT TEVI



**16301** Ø 18 mm  
**16311** pótpenge / Dispozitiv taiat tevi



10  
1

▼ PVC CSŐ VÁGÓ  
DISPOZITIV PENTRU TAIAT TEVI



**16303** Ø 3-32 mm  
**16311** pótpenge / Dispozitiv taiat tevi



10  
1

▼ PVC CSŐ VÁGÓ  
DISPOZITIV PENTRU TAIAT TEVI



**16304** Ø 3-64 mm  
**16310, 16312** pótpenge / Dispozitiv taiat tevi



6  
1

▼ PVC CSŐ VÁGÓ  
DISPOZITIV PENTRU TAIAT TEVI



**17026** max. Ø 42 mm



50

▼ PVC CSŐ VÁGÓ  
DISPOZITIV PENTRU TAIAT TEVI



**17027** max. Ø 42 mm



48

**FESTA**<sup>®</sup>

▼ TARTALÉK VAGÓKERÉK PVC CSŐVÁGÓHOZ  
ROATE SCHIMB PENTRU TAIETOR TEVI

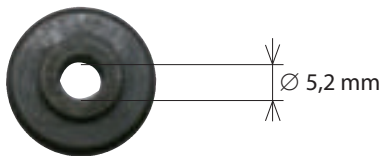

**16310** Ø 17,5 mm x 6 mm 16300, 16304 1  
**16311** Ø 18,0 mm x 4,5 mm 16303, 16301 1  
**16312** Ø 27,5 mm x 6 mm 16304 1



1

▼ TARTALÉK PENGE 17027-HEZ  
LAME DE SCHIMB



**16315** ért/ pentru 17027



12

▼ CSŐSORJÁZÓ  
SLEFUITOR MUCHII PLASTIC



**16320** Ø 6-42 mm



1

▼ DARABOLÓ OLLÓ, PROFILOKHOZ  
FOARFECA PENTRU PROFILE



lecek, csövek, profilok  
plinte, profile, tevi

**17050** Ø 16 mm, 19 mm, 25 mm



8

**FESTA**<sup>®</sup>

CSIGAFÚRÓ FÉMHEZ HSS-COBALT 5% - DIN 338  
BURGHIE HSS-COBALT 5% - DIN 338

FESTA®



Co 5%, W 9%, Mo 5%, Cr 4%, V 1%

22510	∅ 1,00 mm	5	22542	∅ 4,20 mm	5	22570	∅ 7,00 mm	5	22605	∅ 10,50 mm	5
22515	∅ 1,50 mm	5	22545	∅ 4,50 mm	5	22575	∅ 7,50 mm	5	22610	∅ 10,20 mm	5
22520	∅ 2,00 mm	5	22548	∅ 4,80 mm	5	22580	∅ 8,00 mm	5	22615	∅ 11,50 mm	5
22525	∅ 2,50 mm	5	22550	∅ 5,00 mm	5	22585	∅ 8,50 mm	5	22620	∅ 12,00 mm	5
22530	∅ 3,00 mm	5	22555	∅ 5,50 mm	5	22590	∅ 9,00 mm	5	22625	∅ 12,50 mm	5
22532	∅ 3,20 mm	5	22560	∅ 6,00 mm	5	22595	∅ 9,50 mm	5	22630	∅ 13,00 mm	5
22535	∅ 3,50 mm	5	22565	∅ 6,50 mm	5	22600	∅ 10,00 mm	5			5
22540	∅ 4,00 mm	5	22568	∅ 6,80 mm	5	22602	∅ 10,20 mm	5			5

CSIGAFÚRÓ FÉMHEZ HSS-G W9 - DIN 338  
BURGHIE HSS-G W9 - DIN 338

FESTA®



W 9%, Mo 3%, Cr 4%, V 1%

19530	∅1.00 mm	10	19564	∅ 4.40 mm	10	19598	∅ 7.80 mm	5	19632	∅ 11.20 mm	3
19531	∅1.10 mm	10	19565	∅ 4.50 mm	10	19599	∅ 7.90 mm	5	19633	∅ 11.30 mm	3
19532	∅1.20 mm	10	19566	∅ 4.60 mm	10	19600	∅ 8.00 mm	5	19634	∅ 11.40 mm	3
19533	∅1.30 mm	10	19567	∅ 4.70 mm	10	19601	∅ 8.10 mm	5	19635	∅ 11.50 mm	3
19534	∅1.40 mm	10	19568	∅ 4.80 mm	10	19602	∅ 8.20 mm	5	19636	∅ 11.60 mm	3
19535	∅1.50 mm	10	19569	∅ 4.90 mm	5	19603	∅ 8.30 mm	5	19637	∅ 11.70 mm	3
19536	∅1.60 mm	10	19570	∅ 5.00 mm	5	19604	∅ 8.40 mm	5	19638	∅ 11.80 mm	3
19537	∅1.70 mm	10	19571	∅ 5.10 mm	5	19605	∅ 8.50 mm	5	19639	∅ 11.90 mm	3
19538	∅1.80 mm	10	19572	∅ 5.20 mm	5	19606	∅ 8.60 mm	5	19640	∅ 12.00 mm	3
19539	∅1.90 mm	10	19573	∅ 5.30 mm	5	19607	∅ 8.70 mm	5	19641	∅ 12.10 mm	3
19540	∅2.00 mm	10	19574	∅ 5.40 mm	5	19608	∅ 8.80 mm	5	19642	∅ 12.20 mm	3
19541	∅2.10 mm	10	19575	∅ 5.50 mm	5	19609	∅ 8.90 mm	5	19643	∅ 12.30 mm	3
19542	∅2.20 mm	10	19576	∅ 5.60 mm	5	19610	∅ 9.00 mm	5	19644	∅ 12.40 mm	3
19543	∅2.30 mm	10	19577	∅ 5.70 mm	5	19611	∅ 9.10 mm	5	19645	∅ 12.50 mm	3
19544	∅2.40 mm	10	19578	∅ 5.80 mm	5	19612	∅ 9.20 mm	5	19646	∅ 12.60 mm	1
19545	∅2.50 mm	10	19579	∅ 5.90 mm	5	19613	∅ 9.30 mm	5	19647	∅ 12.70 mm	1
19546	∅2.60 mm	10	19580	∅ 6.00 mm	5	19614	∅ 9.40 mm	5	19648	∅ 12.80 mm	1
19547	∅2.70 mm	10	19581	∅ 6.10 mm	5	19615	∅ 9.50 mm	3	19649	∅ 12.90 mm	1
19548	∅2.80 mm	10	19582	∅ 6.20 mm	5	19616	∅ 9.60 mm	3	19650	∅ 13.00 mm	1
19549	∅2.90 mm	10	19583	∅ 6.30 mm	5	19617	∅ 9.70 mm	3	19651	∅ 13.20 mm	1
19550	∅3.00 mm	10	19584	∅ 6.40 mm	5	19618	∅ 9.80 mm	3	19652	∅ 13.50 mm	1
19551	∅3.10 mm	10	19585	∅ 6.50 mm	5	19619	∅ 9.90 mm	3	19653	∅ 14.00 mm	1
19552	∅3.20 mm	10	19586	∅ 6.60 mm	5	19620	∅ 10.00 mm	3	19654	∅ 14.50 mm	1
19553	∅3.30 mm	10	19587	∅ 6.70 mm	5	19621	∅ 10.10 mm	3	19655	∅ 15.00 mm	1
19554	∅3.40 mm	10	19588	∅ 6.80 mm	5	19622	∅ 10.20 mm	3	19656	∅ 15.50 mm	1
19555	∅3.50 mm	10	19589	∅ 6.90 mm	5	19623	∅ 10.30 mm	3	19657	∅ 16.00 mm	1
19556	∅3.60 mm	10	19590	∅ 7.00 mm	5	19624	∅ 10.40 mm	3	19658	∅ 16.50 mm	1
19557	∅3.70 mm	10	19591	∅ 7.10 mm	5	19625	∅ 10.50 mm	3	19659	∅ 17.00 mm	1
19558	∅3.80 mm	10	19592	∅ 7.20 mm	5	19626	∅ 10.60 mm	3	19660	∅ 17.50 mm	1
19559	∅3.90 mm	10	19593	∅ 7.30 mm	5	19627	∅ 10.70 mm	3	19661	∅ 18.00 mm	1
19560	∅4.00 mm	10	19594	∅ 7.40 mm	5	19628	∅ 10.80 mm	3	19662	∅ 18.50 mm	1
19561	∅4.10 mm	10	19595	∅ 7.50 mm	5	19629	∅ 10.90 mm	3	19663	∅ 19.00 mm	1
19562	∅4.20 mm	10	19596	∅ 7.60 mm	5	19630	∅ 11.00 mm	3	19664	∅ 19.50 mm	1
19563	∅4.30 mm	10	19597	∅ 7.70 mm	5	19631	∅ 11.10 mm	3	19665	∅ 20.00 mm	1



### HSS TITAN CSIGAFÚRÓ - DIN 338

HSS BURGHIE TITAN - DIN 338



Titánfelület a magasabb teljesítmény és élettartalom érdekében  
suprafata de titaniu pentru cresterea duratei de viata

20400	∅ 1,0 mm	50	20408	∅ 4,0 mm	50	20416	∅ 6,8 mm	36	20424	∅ 10,2 mm	36
20401	∅ 1,5 mm	50	20409	∅ 4,2 mm	50	20417	∅ 7,0 mm	40	20425	∅ 10,5 mm	40
20402	∅ 2,0 mm	72	20410	∅ 4,5 mm	72	20418	∅ 7,5 mm	40	20426	∅ 11,0 mm	40
20403	∅ 2,5 mm	60	20411	∅ 4,8 mm	60	20419	∅ 8,0 mm	40	20427	∅ 11,5 mm	40
20404	∅ 3,0 mm	72	20412	∅ 5,0 mm	72	20420	∅ 8,5 mm	40	20428	∅ 12,0 mm	40
20405	∅ 3,2 mm	72	20413	∅ 5,5 mm	72	20421	∅ 9,0 mm	40	20429	∅ 12,5 mm	40
20406	∅ 3,5 mm	72	20414	∅ 6,0 mm	72	20422	∅ 9,5 mm	40	20430	∅ 13,0 mm	40
20407	∅ 3,8 mm	50	20415	∅ 6,5 mm	50	20423	∅ 10,0 mm	40			

### CSIGAFÚRÓ FÉMHEZ HSS - DIN 338

BURGHIE HSS - DIN 338



20006	∅ 0,6 mm	10	20040	∅ 4,0 mm	10	20073	∅ 7,3 mm	10	20106	∅ 10,6 mm	5
20007	∅ 0,7 mm	10	20041	∅ 4,1 mm	10	20074	∅ 7,4 mm	10	20107	∅ 10,7 mm	5
20008	∅ 0,8 mm	10	20042	∅ 4,2 mm	10	20075	∅ 7,5 mm	10	20108	∅ 10,8 mm	5
20009	∅ 0,9 mm	10	20043	∅ 4,3 mm	10	20076	∅ 7,6 mm	10	20110	∅ 11,0 mm	5
20010	∅ 1,0 mm	10	20044	∅ 4,4 mm	10	20077	∅ 7,7 mm	10	20112	∅ 11,2 mm	5
20011	∅ 1,1 mm	10	20045	∅ 4,5 mm	10	20078	∅ 7,8 mm	10	20113	∅ 11,3 mm	5
20012	∅ 1,2 mm	10	20046	∅ 4,6 mm	10	20079	∅ 7,9 mm	10	20114	∅ 11,4 mm	5
20013	∅ 1,3 mm	10	20047	∅ 4,7 mm	10	20080	∅ 8,0 mm	5	20115	∅ 11,5 mm	5
20014	∅ 1,4 mm	10	20048	∅ 4,8 mm	10	20081	∅ 8,1 mm	5	20116	∅ 11,6 mm	5
20015	∅ 1,5 mm	10	20049	∅ 4,9 mm	10	20082	∅ 8,2 mm	5	20117	∅ 11,7 mm	5
20016	∅ 1,6 mm	10	20050	∅ 5,0 mm	10	20083	∅ 8,3 mm	5	20118	∅ 11,8 mm	5
20017	∅ 1,7 mm	10	20051	∅ 5,1 mm	10	20084	∅ 8,4 mm	5	20119	∅ 11,9 mm	5
20018	∅ 1,8 mm	10	20052	∅ 5,2 mm	10	20085	∅ 8,5 mm	5	20120	∅ 12,0 mm	5
20019	∅ 1,9 mm	10	20053	∅ 5,3 mm	10	20086	∅ 8,6 mm	5	20122	∅ 12,2 mm	5
20020	∅ 2,0 mm	10	20054	∅ 5,4 mm	10	20087	∅ 8,7 mm	5	20125	∅ 12,5 mm	5
20021	∅ 2,1 mm	10	20055	∅ 5,5 mm	10	20088	∅ 8,8 mm	5	20128	∅ 12,8 mm	5
20022	∅ 2,2 mm	10	20056	∅ 5,6 mm	10	20089	∅ 8,9 mm	5	20129	∅ 12,9 mm	5
20023	∅ 2,3 mm	10	20057	∅ 5,7 mm	10	20090	∅ 9,0 mm	5	20130	∅ 13,0 mm	5
20024	∅ 2,4 mm	10	20058	∅ 5,8 mm	10	20091	∅ 9,1 mm	5	20132	∅ 13,2 mm R13	5
20025	∅ 2,5 mm	10	20059	∅ 5,9 mm	10	20092	∅ 9,2 mm	5	20135	∅ 13,5 mm R13	1
20026	∅ 2,6 mm	10	20060	∅ 6,0 mm	10	20093	∅ 9,3 mm	5	20140	∅ 14,0 mm R13	1
20027	∅ 2,7 mm	10	20061	∅ 6,1 mm	10	20094	∅ 9,4 mm	5	20145	∅ 14,5 mm R13	1
20028	∅ 2,8 mm	10	20062	∅ 6,2 mm	10	20095	∅ 9,5 mm	5	20150	∅ 15,0 mm R13	1
20029	∅ 2,9 mm	10	20063	∅ 6,3 mm	10	20096	∅ 9,6 mm	5	20155	∅ 15,5 mm R13	1
20030	∅ 3,0 mm	10	20064	∅ 6,4 mm	10	20097	∅ 9,7 mm	5	20160	∅ 16,0 mm R13	1
20031	∅ 3,1 mm	10	20065	∅ 6,5 mm	10	20098	∅ 9,8 mm	5	20165	∅ 16,5 mm R13	1
20032	∅ 3,2 mm	10	20066	∅ 6,6 mm	10	20099	∅ 9,9 mm	5	20170	∅ 17,0 mm R13	1
20033	∅ 3,3 mm	10	20067	∅ 6,7 mm	10	20100	∅ 10,0 mm	5	20175	∅ 17,5 mm R13	1
20034	∅ 3,4 mm	10	20068	∅ 6,8 mm	10	20101	∅ 10,1 mm	5	20180	∅ 18,0 mm R13	1
20035	∅ 3,5 mm	10	20069	∅ 6,9 mm	10	20102	∅ 10,2 mm	5	20185	∅ 18,5 mm R13	1
20036	∅ 3,6 mm	10	20070	∅ 7,0 mm	10	20103	∅ 10,3 mm	5	20190	∅ 19,0 mm R13	1
20037	∅ 3,7 mm	10	20071	∅ 7,1 mm	10	20104	∅ 10,4 mm	5	20195	∅ 19,5 mm R13	1
20038	∅ 3,8 mm	10	20072	∅ 7,2 mm	10	20105	∅ 10,5 mm	5	20200	∅ 20,0 mm R13	1
20039	∅ 3,9 mm	10									

### CSIGAFÚRÓ FÉMHEZ HSS - DIN 338

BURGHIE HSS - DIN 338



20220	∅ 2x80 mm	10	20240	∅ 4x115 mm	10	20255	∅ 5,5x135 mm	10	20280	∅ 8x160 mm	5
20225	∅ 2,5x90 mm	10	20245	∅ 4,5x115 mm	10	20260	∅ 6x135 mm	10	20290	∅ 9x160 mm	5
20230	∅ 3x110 mm	10	20250	∅ 5x130 mm	10	20270	∅ 7x150 mm	10	20296	∅ 10x175 mm	5
20235	∅ 3,5x110 mm	10									

CSISZOLT FÉMFÚRÓSZÁR KÉSZLET DIN 338  
SET BURGHIE HSS RECTIFICATE

FESTA®



W 9%, Mo 3%, Cr 4%, V 1%

20333 13 db/buc Ø 1,5 - 6,5 mm



50

CSISZOLT FÉMFÚRÓSZÁR KÉSZLET DIN 338  
SET BURGHIE HSS RECTIFICATE

FESTA®



W 9%, Mo 3%, Cr 4%, V 1%

20334 19 db/buc Ø 1,0 - 10,0 mm



20

CSISZOLT FÉMFÚRÓSZÁR KÉSZLET DIN 338  
SET BURGHIE HSS RECTIFICATE

FESTA®



W 9%, Mo 3%, Cr 4%, V 1%

20335 25 db/buc Ø 1,0 - 13,0 mm



20

CSISZOLT FÉMFÚRÓSZÁR KÉSZLET DIN 338  
SET BURGHIE HSS RECTIFICATE

FESTA®

NEW



W 4%, Mo 3%, Cr 4%, V 1%

20336 13 db/buc Ø 1,5 - 6,5 mm



50

CSISZOLT FÉMFÚRÓSZÁR KÉSZLET DIN 338  
SET BURGHIE HSS RECTIFICATE

FESTA®

NEW



W 4%, Mo 3%, Cr 4%, V 1%

20337 19 db/buc Ø 1,0 - 10,0 mm



20

CSISZOLT FÉMFÚRÓSZÁR KÉSZLET DIN 338  
SET BURGHIE HSS RECTIFICATE

FESTA®

NEW



W 4%, Mo 3%, Cr 4%, V 1%

20338 25 db/buc Ø 1,0 - 13,0 mm



20

HSS CSIGAFÚRÓ KLT. FÉMHEZ  
SET HSS BURGHIE



20300 13 db/buc HSS Ø 1,5 - 6,5 mm



10

HSS CSIGAFÚRÓ KLT. FÉMHEZ  
SET HSS BURGHIE



20305 19 db/buc HSS Ø 1 - 10 mm



20

HSS CSIGAFÚRÓ KLT. FÉMHEZ - DIN 338  
SET HSS BURGHIE DIN 338



20315 19 db/buc HSS Ø 1 - 10 mm



20

HSS CSIGAFÚRÓ KLT. FÉMHEZ- DIN 338  
SET HSS BURGHIE 338



20310 19 db/buc HSS Ø 1 - 13 mm



5

CSIGAFÚRÓ KLT. FÉMHEZ - DIN 338  
SET BURGHIE DIN 338



20321 19 db/buc HSS Ø 1 - 10x0,5 mm



5

CSIGAFÚRÓ KLT. FÉMHEZ - DIN 338  
SET BURGHIE DIN 338



20311 25 db/buc HSS Ø 1 - 13 mm



5

CSIGAFÚRÓ KLT. FÉMHEZ - DIN 338  
SET BURGHIE DIN 338



20320 19 db/buc TITAN Ø 1 - 10 x 0,5 mm



5

DRILL SET - HATSZÖGLETŰ SZÁRRAL  
DRILL SET - CU TULPINÁ CU CAP HEXAGONAL

NEW  
Ø 1/4"



20316 7 db/buc HSS Ø 1,5-2-3-4-5-5,5-6 mm



10

KÖZETFÚRÓ  
BURGHIU

NEW



W 4%, Mo 3%, Cr 4%, V 1%



20210 7,5 / 5,0 - 50 mm

5

HSS LÉPTETŐ FÚRÓSZÁR TITAN  
BURGHIU IN TREPTE TITAN

FESTA®



20489	∅ 4-12 mm	/ 8 steps	10
20490	∅ 4-20 mm	/ 9 steps	10
20491	∅ 5-35 mm	/ 13 steps	10
20492	∅ 7-40,5 mm	/ 13 steps	5

HSS LÉPTETŐ FÚRÓSZÁR  
BURGHIU IN TREPTE



20487	∅ 4-20 mm	/ 9 steps	10
20488	∅ 5-35 mm	/ 13 steps	10

HSS KORONÁS FÚRÓ BIMETAL  
SET CAROTE HSS BI-METAL

FESTA®



Fémbe / pentru metal

MAX. 8 mm



24750 9 db/buc ∅ 19, 22, 29, 38, 44, 57 mm

10

HSS KORONÁS FÚRÓ BIMETAL  
SET CAROTE HSS BI-METAL

FESTA®



Fémbe / pentru metal

MAX. 8 mm



24751 13 db/buc ∅ 19, 22, 29, 35, 38, 44, 51, 57, 64 mm

10

KÉZI MARÓK  
SET FREZE

1/4"



20360 3 db/buc HSS

10

FÚRÓ ÉLEZŐ  
ASCUTITOR BURGHIE



HOBBY



20380

20



KÖZETFÚRÓ - DIN 8039  
BURGHU - DIN 8039

FESTA®



20673	∅ 3 x 60 mm	100	20678	∅ 8 x 120 mm	50	20691	∅ 10 x 300 mm	25	20684	∅ 14 x 150 mm	25
20674	∅ 4 x 75 mm	100	20686	∅ 8 x 200 mm	50	20692	∅ 10 x 400 mm	25	Befogás / reductie ∅ 0 mm		
20675	∅ 5 x 85 mm	100	20687	∅ 8 x 300 mm	25	20682	∅ 12 x 150 mm	50	20697	∅ 14 x 300 mm	5
20676	∅ 6 x 100 mm	100	20688	∅ 8 x 400 mm	25	20694	∅ 12 x 300 mm	25	Befogás / reductie ∅ 0 mm		
20677	∅ 6 x 200 mm	50	20680	∅ 10 x 120 mm	50	20696	∅ 12 x 400 mm	25	20698	∅ 14 x 400 mm	15
20685	∅ 6 x 300 mm	50	20690	∅ 10 x 200 mm	50				Befogás / reductie ∅ 0 mm		

KÖZETFÚRÓ SDS+  
BURGHU SDS+

FESTA®

SDS+

Kétélű fúró  
cap vidia simplu



20830	∅ 4x110 mm	100	20837	∅ 8x160 mm	50	20841	∅ 10x210 mm	50	20856	∅ 14x260 mm	25
20831	∅ 5x110 mm	100	20838	∅ 8x210 mm	50	20848	∅ 12x160 mm	25	20858	∅ 14x460 mm	15
20832	∅ 6x110 mm	100	20839	∅ 8x260 mm	25	20850	∅ 12x260 mm	25			
20834	∅ 6x210 mm	50	20829	∅ 8x350 mm	25	20852	∅ 12x460 mm	10			
20835	∅ 6x260 mm	25	20840	∅ 10x160 mm	50	20855	∅ 14x160 mm	25			

KÖZETFÚRÓ SDS+  
BURGHU SDS+

FESTA®

SDS+

Négyélű fúró, nagyobb teljesítménnyel és tartóssággal  
cap vidia in cruce, pentru marirea duratei de viata



20748	∅ 6 x 110 mm	50	NEW 20759	∅ 10 x 350 mm	50	20773	∅ 14 x 350 mm	25	20787	∅ 18 x 1000mm	20
20749	∅ 6 x 160 mm	50	NEW 20760	∅ 10 x 450 mm	50	20774	∅ 14 x 460 mm	25	20788	∅ 20 x 450 mm	20
20750	∅ 6 x 210 mm	50	20761	∅ 10 x 600 mm	50	20775	∅ 14 x 600 mm	25	20789	∅ 20 x 600 mm	20
20751	∅ 6 x 260 mm	50	20762	∅ 10 x 1000mm	50	20776	∅ 14 x 1000mm	30	20790	∅ 20 x 800 mm	25
NEW 20861	∅ 6,5 x 230 mm	50	20763	∅ 12 x 110 mm	50	20777	∅ 16 x 160 mm	25	20791	∅ 20 x 1000mm	10
NEW 20862	∅ 6,5 x 300 mm	50	20764	∅ 12 x 160 mm	50	20778	∅ 16 x 210 mm	25	20792	∅ 22 x 450 mm	20
20752	∅ 8 x 110 mm	50	20765	∅ 12 x 210 mm	50	20779	∅ 16 x 260 mm	25	20793	∅ 22 x 600 mm	20
20753	∅ 8 x 160 mm	50	20766	∅ 12 x 260 mm	50	20780	∅ 16 x 350 mm	25	20794	∅ 22 x 800 mm	20
20754	∅ 8 x 210 mm	50	20767	∅ 12 x 350 mm	50	20781	∅ 16 x 460 mm	25	20795	∅ 22 x 1000mm	10
20755	∅ 8 x 260 mm	50	20768	∅ 12 x 460 mm	50	20782	∅ 16 x 600 mm	30	20796	∅ 24 x 450 mm	10
20825	∅ 8 x 350 mm	50	20769	∅ 12 x 600 mm	25	20783	∅ 16 x 1000mm	25	20797	∅ 24 x 600 mm	20
20756	∅ 10 x 160 mm	50	20770	∅ 12 x 1000mm	25	20784	∅ 18 x 260 mm	25	20798	∅ 24 x 800 mm	10
20757	∅ 10 x 210 mm	50	20771	∅ 14 x 160 mm	25	20785	∅ 18 x 450 mm	25	20799	∅ 24 x 1000mm	10
20758	∅ 10 x 260 mm	50	20772	∅ 14 x 260 mm	25	20786	∅ 18 x 600 mm	32			

KÖZETFÚRÓ SDS MAX  
BURGHU SDS MAX

FESTA®



SDS MAX

NEW 20520	∅ 18 x 800 mm	20
NEW 20521	∅ 20 x 800 mm	17
NEW 20522	∅ 22 x 800 mm	17
NEW 20523	∅ 24 x 800 mm	10
NEW 20524	∅ 28 x 800 mm	10
NEW 20525	∅ 30 x 800 mm	10
NEW 20526	∅ 40 x 800 mm	5

**KÖZETFÚRÓ KÉSZLET SDS+  
SET BURGHIE SDS+**

SDS+

**20890** 5 db/buc  $\varnothing$  5, 6, 8, 10, 12 x 160 mm

**20891** 6 db/buc  $\varnothing$  5, 6, 8 x 110 mm  
 $\varnothing$  8, 10, 12 x 160 mm

**KÖZETFÚRÓ KÉSZLET  
SET BURGHIE**

HOBBY

**20805** 5 db/buc  $\varnothing$  4 - 10 mm

**20820** 8 db/buc  $\varnothing$  3 - 10 mm

**FÉSŐ HELYETT VÉSŐ SDS+  
SET BURGHIE, DALTI SPITURI, SDS+**

FESTA®

 2x vésőhegy/dalta simpla  
 3x vágó/dalta  
 12x közetfúró/burghie  
 $\varnothing$  5-12 mm

SDS+

**20952** 17 db/buc

**LAPOS VÉSŐ SDS MAX  
DALTA SDS MAX**

FESTA®



SDS MAX

**20940** 18 x 280 x 25 mm

**20941** 18 x 280 x 40 mm

**20942** 18 x 280 x 75 mm

**20943** 18 x 400 x 25 mm

**20944** 18 x 400 x 40 mm

**20945** 18 x 600 x 25 mm

**20946** 18 x 600 x 40 mm

25

25

25

25

25

20

10

**LAPOS VÉSŐ SDS +  
DALTA SDS +**

FESTA®



SDS+

**20948** 14 x 250 x 20 mm

**20949** 14 x 250 x 40 mm

25

25

**FÚRÓKÉSZLET KÖRE  
BURGHIE ZIDARIE**

DIN 8039

**20895** 6 db/buc  $\varnothing$  5, 6, 8, 8, 10, 12 mm

20

**FÉSŐ HELYETT VÉSŐ SDS+  
SET BURGHIE, DALTI SPITURI, SDS+**

FESTA®

 3x vágó/dalta  
 9x közetfúró/  
 burghie

SDS+

**20950** 12 db/buc

8

**SPICC VÉSŐ SDS MAX  
DALTA SDS MAX**

FESTA®



SDS MAX

**20937** 18 x 280 mm

25

**20938** 18 x 400 mm

25

**20939** 18 x 600 mm

20

**SPICC VÉSŐ SDS +  
DALTA SDS +**

FESTA®



SDS+

**20947** 14 x 250 mm

20

**HORONYMARÓ SDS+  
DALTA SDS +**

FESTA®



SDS+

**20956** 14 x 250 x 22 mm

25

FÉSŐ HELYETT VÉSŐ SDS+  
SET BURGHIE, DALTI SPITURI, SDS+

FESTA®



20954 4 db/buc

SDS+



KORONA FÚRÓSZÁR SDS+  
CAROTA PENTRU DOZE-DINTI TC SDS+

FESTA®



SDS+



NEW 24719	∅ 67 mm	10
24717	∅ 73 mm	20
24718	∅ 100 mm	20
NEW 24732	Náhradní upínací stopka	20

FÚRÓSZÁR BEFOGÓ ADAPTER SDS MAX  
LIMITATOR DE PRINDERE PENTRU COROANE DE GAURIT  
MAX.

FESTA®



24730 180 mm

SDS+



FÚRÓSZÁR BEFOGÓ ADAPTER SDS+  
LIMITATOR DE PRINDERE PENTRU COROANE DE GAURIT  
SDS+

FESTA®



24731 300 mm

SDS+



KÖRKIVÁGÓ  
COROANA

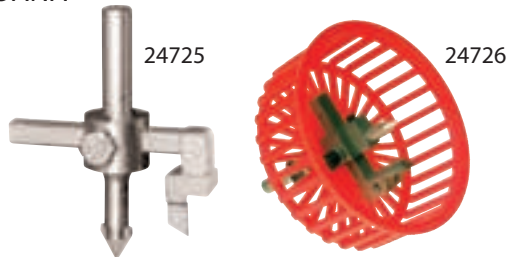

24725 ∅ 20 - 95 mm  
24726 + kosár/cu colivie



KÖRKIVÁGÓ KORONG CSEMPÉRE  
COROANA TCT  
PENTRU DECUPAT

FESTA®



24735	∅ 33 mm	1	24740	∅ 83 mm	1
24736	∅ 43 mm	1	24741	∅ 103 mm	1
24737	∅ 53 mm	1	24743	holder ∅33-103mm	1
24738	∅ 67 mm	1	24748	holder ∅33-83mm	10
24739	∅ 73 mm	1	24749	közetfúró/burghie 100	

GYÉMÁNT KÖRKIVÁGÓ  
COROANE DIAMANTATE

FESTA®



üvegre és kerámiára  
pentru sticla si ceramica

24770	∅ 4 mm	1
24771	∅ 6 mm	1
24772	∅ 8 mm	1
24773	∅ 10 mm	1
24774	∅ 12 mm	1



FÚRÓSZÁR MEGVEZETŐ  
MASINA DE GHIDARE



20379 ∅ 4, 5, 6, 6.5, 8, 10, 12, 13 mm



KÖRKIVÁGÓ KÉSZLET CSEMPÉRE  
SET COROANE TCT PENTRU DECUPAT

FESTA®



24745 6 ks/pcs ∅ 33, 53, 67, 73 mm  
Vivó/surub de ghidaj, közetfúró/burghie



KÖRKIVÁGÓ KÉSZLET CSEMPÉRE  
SET COROANE TCT PENTRU DECUPAT

FESTA®



24746 ∅ 103 mm  
Vivó/surub de ghidaj, közetfúró/burghie



SC KÖSZÖRŰ CSEMPÉRE  
PILA CU CARBURI PENTRU PLACI

NEW



22201 200 mm

SC KÖSZÖRŰ CSEMPÉRE  
PILA CU CARBURI PENTRU PLACI

22200

KÖRKIVÁGÓ KÉSZLET CSEMPÉRE  
SET COROANE TCT  
PENTRU DECUPAT24747 8 ks/pcs Ø 33, 53, 67, 73, 83 mm  
Vivő/surub de ghidaj, közetfúró/burghie, SC köszörű csempére/Pila cu carburiCrV LAPOSVÉSŐ  
DALTA LATA, Crv

FESTA®

19460 300 mm / 25 mm  
19470 400 mm / 30 mm

CrV

CrV LAPOSVÉSŐ  
DALTA LATA, Crv

FESTA®

19406 300 mm / 25 mm  
19407 400 mm / 30 mm

CrV

SPICCVÉSŐ  
DALTA SPIT19400 250 mm  
19403 350 mm

6

LAPOSVÉSŐ  
DALTA LATA19401 250 mm  
19404 350 mm

6

LAPOSVÉSŐ  
DALTA LATA19402 250 mm / 50 mm  
19405 350 mm / 50 mm

6

HIDEGVÁGÓ  
DALTA PLATA

FESTA®

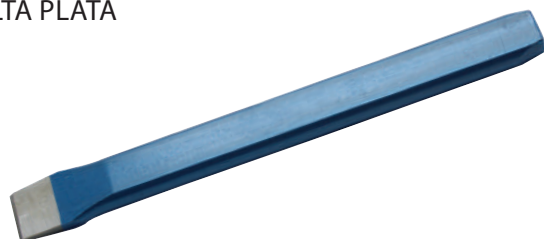
19410 21,5 x 200 mm  
19411 25 x 250 mm  
19412 25 x 300 mm

CrV



10

LYUKASZTÓK  
POANSON

FESTA®



19483 6 db/buc Ø 3, 4, 5, 6, 7, 8 mm

CrV



6

VÉSŐ, LYUKASZTÓ, PONTOZÓ  
SET DALTI SI POANSOANE

FESTA®



2, 6, 8 mm  
10, 12, 16 mm  
Ø 1-5-3-4,5-6-8 mm

CrV



19487 12 db/buc

16

VÉSŐ KLT.  
SET DALTI

FESTA®



CrV



19485 3 db/buc, 10x142, 12x152, 16x172 mm

10

LYUKASZTÓK CrV  
DORN, SET CrV



CrV



19482 6 db/buc 3, 4, 5, 6, 8 mm

10

VÉSŐ, LYUKASZTÓ, PONTOZÓ  
SET DALTI SI POANSOANE

FESTA®



2x140, 8x115 mm  
12x152, 10x142 mm  
3x152, 6x152 mm

CrV



19486 6 db/buc

10

LYUKASZTÓK CrV  
DORN, SET CrV

FESTA®



CrV



19480 3 db/buc 0,8, 1,5, 2,5 mm

10

PONTOZÓK CrV  
PUNCTATOR, SET CrV

FESTA®



CrV



19481 3 db/buc 0,8, 1,5, 2,5 mm

10

AUTOMATA PONTOZÓ  
PUNCTATOR AUTOMAT

FESTA®



CrV



19478 2,5 mm

10

PONTOZÓ  
PUNCTATOR

FESTA®



19477 2,5 mm

10

CSIGAFÚRÓ FÁHOZ  
BURGHIE LEMN SET



20731	Ø8 x 400 mm	10
20730	Ø10 x 400 mm	10
20732	Ø12 x 400 mm	10
20733	Ø14 x 400 mm	10
20734	Ø16 x 400 mm	5
20735	Ø 18 x 400	5

10

10

10

10

5

5



20736	Ø8 x 600 mm	15
20737	Ø10 x 600 mm	10
20738	Ø12 x 600 mm	10
20739	Ø14 x 600 mm	5
20740	Ø16 x 600 mm	5
20741	Ø18 x 600 mm	5

15

10

10

5

5

5

▼ FAFÚRÓ KÉSZLET  
SET BURGHIE LEMN



HOBBY



<b>20910</b>	8 db/buc	∅ 3, 4, 5, 6, 7, 8, 9, 10 mm	10
<b>20905</b>	5 db/buc	∅ 4, 5, 6, 8, 10 mm	10
<b>20900</b>	5 db/buc	∅ 4, 5, 6, 8, 10 mm - PVC bag	10

▼ CSIGAFÚRÓ FÁHOZ  
BURGHIE LEMN



<b>20980</b>	∅ 6 x 230 mm	10	<b>20898</b>	∅ 14 x 300 mm	50
<b>20957</b>	∅ 6 x 300 mm	10	<b>20916</b>	∅ 14 x 450 mm	70
<b>20981</b>	∅ 8 x 230 mm	150	<b>20921</b>	∅ 14 x 600 mm	50
<b>20958</b>	∅ 8 x 300 mm	100	<b>20984</b>	∅ 16 x 230 mm	50
<b>20982</b>	∅ 10 x 230 mm	100	<b>20899</b>	∅ 16 x 300 mm	40
<b>20896</b>	∅ 10 x 300 mm	100	<b>20917</b>	∅ 16 x 450 mm	25
<b>20913</b>	∅ 10 x 450 mm	50	<b>20922</b>	∅ 16 x 600 mm	30
<b>20983</b>	∅ 12 x 230 mm	75	<b>20918</b>	∅ 18 x 450 mm	25
<b>20897</b>	∅ 12 x 300 mm	65	<b>20923</b>	∅ 18 x 600 mm	25
<b>20915</b>	∅ 12 x 450 mm	65	<b>20919</b>	∅ 20 x 450 mm	25
<b>20920</b>	∅ 12 x 600 mm	65	<b>20924</b>	∅ 20 x 600 mm	25

▼ CSIGAFÚRÓ FÁHOZ  
BURGHIE LEMN SET



**20911** 5 db/buc ∅ 8,10,12,14,16 x 460 mm



10

▼ CSIGAFÚRÓ FÁHOZ  
BURGHIE LEMN SET

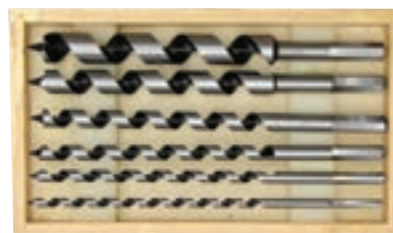

**20912** 6 db/buc ∅ 6,8,10,12, 16,20 x 230 mm



10

▼ FÚRÓ-MARÓ VÉGEK  
SET FREZE LEMN



**21450** 5 db/buc ∅ 8 mm



20

▼ FÚRÓ-MARÓ VÉGEK  
SET FREZE LEMN

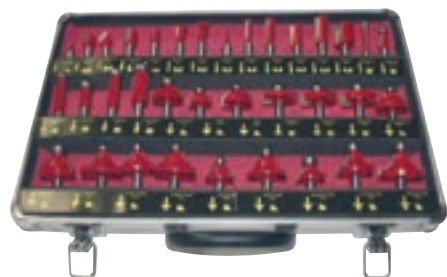

**21453** 35 db/buc ∅ 8 mm



5

▼ FÚRÓ-MARÓ VÉGEK  
SET FREZE LEMN



**21451** 12 db/buc ∅ 8 mm



20

▼ FÚRÓ-MARÓ VÉGEK  
SET FREZE LEMN



**21452** 24 db/buc ∅ 8 mm



10

▼ FÚRÓ-MARÓ VÉGEK  
SET FREZE LEMN



**21454** 59 db/buc ∅ 8 mm



5

PÁNTKIVETŐ KLT.  
SET FREZE LEMN



21530 5 db/buc Ø 15,20,25,35 mm



20

HEGYES FAFÚRÓ KÉSZLET  
SET BURGHIE PLATE



20901 6 db/buc Ø 10, 12, 16, 18, 20, 25 mm

HOBBY



25

MARÓ FÚRÓSZÁR HSS TITAN  
BURGHIIU FREZARE TITAN HSS



TIN



20460 Ø 6 mm TITAN HSS

50

MARÓ FÚRÓKÉSZLET  
SET BURGHIE FREZARE TITAN HSS



20450 6 db/buc TITAN HSS Ø 3, 4, 5, 6, 6.5, 8 mm



10

KÖRKIVÁGÓ - KLT.  
SET COROANE

FESTA®



Ø 64 mm  
Ø 76 mm  
Ø 89 mm  
Ø 102 mm  
Ø 127 mm  
imbusz/  
cheie hexagonala  
Fej, fejecske/  
portscula



24706 8 db/buc

20

KÖRKIVÁGÓ ÁLLÍTHATÓ  
DISPOZITIV PENTRU GAURIT, REGLABIL



24716 Ø 30 - 120 mm



5

KÖRKIVÁGÓ - KLT.  
SET COROANE  
imbusz/cheie hexagonala 2x  
Fej, fejecske/portscula

FESTA®



Ø 19 mm  
Ø 22 mm  
Ø 25,5  
mm  
Ø 36 mm  
Ø 44 mm  
Ø 51 mm  
Ø 60 mm  
Ø 67 mm  
Ø 82 mm



24712 12 db/buc

20

KÖRKIVÁGÓ FÁRA ÉS GIPSZKARTONRA  
COROANA

FESTA®



24715 Ø 67 mm  
24714 Ø 102 mm  
24713 Ø 73 mm



5

5

5

TÖRTCSAVAR KISZEDŐ  
EXTRACTOR SURUBURI

FESTA®



20387 PROFI 8 db/buc- Ø 4, 4.5, 6.5, 7.5, 11, 15, 19, 24



1

KÖRKIVÁGÓ - KLT.  
SET COROANE

FESTA®



24721 1" - Ø 26, 32, 38, 45, 50, 56, 63 mm  
24722 2" - Ø 26, 32, 38, 45, 50, 56, 63 mm

HOBBY



10

10

▼ TÖRTCSAVAR KISZEDŐ  
EXTRACTOR SURUBURI



FESTA®

∅ 4 mm  
∅ 4,5 mm  
∅ 6 mm  
∅ 7,5 mm  
∅ 11 mm



20386 5 db/buc PROFI

10

▼ TÖRTCSAVAR KISZEDŐ  
EXTRACTOR SURUBURI



∅ 4 mm  
∅ 4,5 mm  
∅ 6 mm  
∅ 7,5 mm  
∅ 11 mm

HOBBY



20385 5 db/buc HOBBY

10

▼ SZORÍTÓ TOKMÁNY  
MANDRINA CU CHEIE



FESTA®

20960 1-13 mm + klucs/cu cheie, 1/2" - 20 UNF  
20966 13 mm 1/2"



50

50

▼ TOLDAT 90° FÚRÁSRA  
ADAPTOR PENTRU GAURIRE LA 90°



20365



10

▼ GYORSBEFOGÓ TOKMÁNY  
MANDRINA RAPIDA



20961 1,5-13 mm, 1/2" - 20 UNF



50

▼ GYORSBEFOGÓ TOKMÁNY  
MANDRINA RAPIDA

FESTA®



20965 1,5-13 mm, 1/2" - 20 UNF



50

▼ Adapter SDS MAX / SDS +  
Adaptor SDS MAX / SDS +



20744



10

▼ ADAPTER SDS+/1/2 UNF  
ADAPTOR SDS+/1/2 UNF



20745



10

▼ KÉZIFÚRÓ KLT.  
SET SFREDELE



20381 4 db/buc ∅ 2,3,4,5 mm

HOBBY



12

▼ MENETFÚRÓ KLT., FÉM DOBOZ  
TAROZI SET

FESTA®



20390 21 db/buc M3,4,5,6,8,10,12



20



MENETVÁGÓ ÉS FÚRÓ KLT.  
TAROZI SI FILIERE SET

FESTA®



20391 32 db/buc M3,4,5,6,8,10,12



10

MENETFÚRÓ HAJTÓSZÁR  
SUPORT PENTRU TAROZI

FESTA®



20395 1-1/2", M3-M12

DIN 1814



10

HAJTÓSZÁR RACSNIS  
CLICHET REGLABIL M3- M8



20397 M3-M8



30

MENETVÁGÓ HAJTÓSZÁR  
SUPORT PENTRU FILIERE

FESTA®



20396 25x9 mm

DIN 225



10

BETŰ BEÚTÓ  
POANSON LITERE



20970 6 mm  
20971 8 mm



5

5

SZÁM BEÚTÓ  
POANSON NUMERE



20972 6 mm  
20973 8 mm



5

5

LYUKASZTÓ  
SET PENE ROTUNDE



24695 13 db/buc Ø 5, 6, 8, 10, 11, 13, 16, 19  
22, 25, 28, 32, 35 mm

küze, lino, plasty  
leather, lino, plastics



5

LYUKASZTÓ  
SET PENTRU PREDUCIT



24690 9 db/buc Ø 2,5-10 mm  
24691 15 db/buc Ø 2-22 mm



10

10

PROFILMARÓ KLT.  
FREZE METALICE - SET



21541 5 db/buc



10

CSAPOSKÓ KLT.  
PIETRE CU TIJA (BIAX) - SET



21540 5 db/buc



25

▼ SAROKCSISZOLÓ TOLDAT  
ACCESORII PENTRU SLEFUIT



**24755** 100 db/buc



▼ SAROKCSISZOLÓ TOLDAT  
ACCESORII PENTRU SLEFUIT



**24756** 150 db/buc



▼ RS-G ÜVEGVÁGÓ  
TAIETOR GEAM RS-G



**20350**



▼ CSAPÁGYLEHÚZÓ  
EXTRACTOR 3 BRATE



**23730** 100 mm

**23731** 150 mm

**23732** 200 mm



30

10

6

# FESTA®

## Forgó csiszolókefe

Szabadalmazott (edzett) drótok  
A lengés magasfokú kiegyensúlyozása  
Tipusok a rozsdamentes anyagokra is

## perii rotative abrazive

sarme intarite  
grad inalt de echilibrare  
tipuri de materiale inoxidabile

### KÖRKEFE DÖNTÖTT PERIE CONICA

**FESTA®**

**22001** Ø 100 mm M14 s 0,3

60

### FAZÉKKEFE PERIE CUPA

**FESTA®**

**22002** Ø 75 mm M14 s 0,3  
**22003** Ø 100 mm M14 s 0,3

80

36

### FAZÉKKEFE SODROTT PERIE CUPA RASUCITA

**FESTA®**

<b>22004</b>	Ø 65 mm	M14	s 0,5	60
<b>22005</b>	Ø 80 mm	M14	s 0,5	24
<b>22006</b>	Ø 100 mm	M14	s 0,5	24
<b>22037</b>	Ø 65 mm	M14	s 0,5 inox	1
<b>22038</b>	Ø 80 mm	M14	s 0,5 inox	1



### KÖRKEFE + HÉZAGOLÓ GYÜRÜK PERIE ROTATIVA

**FESTA®**

 + Redukciós gyűrűk  
/rinele de reductie

<b>22007</b>	Ø 100 mm	Ø 20,0	s 0,3	60
<b>22008</b>	Ø 125 mm	Ø 20,2	s 0,3	42
<b>22009</b>	Ø 150 mm	Ø 32,2	s 0,3	32
<b>22010</b>	Ø 175 mm	Ø 32,2	s 0,3	20
<b>22011</b>	Ø 200 mm	Ø 32,2	s 0,3	20



### KÖRKEFE SODROTT SAROKCSISZOLÓRA PERIE ROTATIVA RASUCITA

**FESTA®**

<b>22012</b>	Ø 100 mm	M 14	s 0,5	60
<b>22013</b>	Ø 115 mm	M 14	s 0,5	42
<b>22014</b>	Ø 125 mm	M 14	s 0,5	42
<b>22015</b>	Ø 150 mm	M 14	s 0,5	32
<b>22016</b>	Ø 178 mm	M 14	s 0,5	20
<b>22039</b>	Ø 100 mm	M 14	s 0,5 inox	1
<b>22040</b>	Ø 125 mm	M 14	s 0,5 inox	1



### KÖRKEFE SODROTT DÖNTÖTT PERIE CONICA RASUCITA

**FESTA®**

**22017** Ø 100 mm M14 s 0,5

60

### ECSETKEFE PERIE PENSULA, TIJA

**FESTA®**

<b>22018</b>	Ø 12 mm	s 0,3	15
<b>22019</b>	Ø 17 mm	s 0,3	15
<b>22020</b>	Ø 25 mm	s 0,3	25



### ECSETKEFE SODROTT PERIE PENSULA RASUCITA

**FESTA®**

22021, 22022      22058, 22059

<b>22021</b>	Ø 19 mm	s 0,5	30
<b>22022</b>	Ø 22 mm	s 0,5	25
<b>NEW 22058</b>	Ø 12 mm	s 0,3	25
<b>NEW 22059</b>	Ø 25 mm	s 0,3	25



▼ KÖRKEFE CSAPOS, SODROTT  
PERIE ROTATIVA RASUCITA CU TIJA

FESTA®



22023 Ø 75 mm s 0,5



▼ FAZÉKKEFE CSAPOS, SODROTT  
PERIE CUPA RASUCITA

FESTA®



22024 Ø 75 mm s 0,5



▼ KÖRKEFE CSAPOS DÖNTÖTT  
PERIE CONICA RASUCITA CU TIJA

FESTA®



22025 Ø 75 mm s 0,5



▼ KÖRKEFE CSAPOS  
PERIE MULTIFUNCTIONALA, TIJA

FESTA®



22026 Ø 50 mm s 0,3  
22027 Ø 63 mm s 0,3  
22028 Ø 75 mm s 0,3  
22029 Ø 100 mm s 0,3



▼ FAZÉKKEFE CSAPOS  
PERIE MULTIFUNCTIONALA CUPA, TIJA

FESTA®



22030 Ø 65 mm s 0,3  
22031 Ø 75 mm s 0,3



▼ POLÍR KÖRKEFE CSAPOS  
PERIE EVANTAI, TIJA

FESTA®

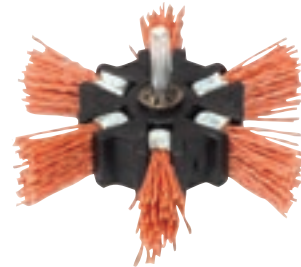

karbid/carbura nylon

22032 Ø 100 mm



▼ DRÓTKEFE  
PERIE MANUALA



22033 4 soros/randuri 300 mm  
22034 5 soros/randuri 300 mm



▼ DRÓTKEFE MŰA.NYELŰ  
PERIE MANUALA OTEL, METAL



22035 Acél/otel 270 mm  
22036 Rozsdamentes/otel inoxidabil 270 mm



▼ BRONZSZÁLAS DRÓTKEFE, FÁRA  
PERIE MICA DE SARMA, LEMN



22078 kis / mic



▼ BRONZSZÁLAS DRÓTKEFE, FÁRA  
PERIE MICA DE SARMA, LEMN



22079 standard / standard



DRÓTKEFE MŪA.NYELŰ  
PERIE MANUALA DE PLASTIC



22080 5 soros/randuri plastic 300 mm 12



DRÓTKEFE MŪA.NYELŰ  
PERIE MANUALA DE PLASTIC

NEW



22080 5 soros/randuri plastic 300 mm 12



BRONZ ÉS FÉM SZÁLAS DRÓTKEFE KÉSZLET  
SET DE PERII SARMA PLASTIC



22081 3 db/buc plastic 10



KÖRKEFE NYLON  
DISC NYLON



22088	Ø 65 mm	stopka	15
22090	Ø 100 mm	stopka	10
22094	Ø 150 mm	bez stopky	10
22095	Ø 178 mm	bez stopky	10



GUMITÁNYÉR CSAPOS  
SUPORT PENTRU DISC VELCRO

FESTA®



22062	Ø115mm, M14 + Szár/maner Ø8mm, EVA 10 mm	10
22063	Ø125mm, M14 + Szár/maner Ø8mm, EVA 10 mm	10
22064	Ø150mm, M14 + Szár/maner Ø8mm, EVA 10 mm	10



KÖRKEFE NYLON  
DISC NYLON



22083	Ø 115 mm	10
22084	Ø 125 mm	10
22085	Ø 150 mm	10



GUMITÁNYÉR CSAPOS  
SUPORT PENTRU DISC VELCRO



22041	Ø 125 mm Csavarral való befogás/prindere cu surub	11
22042	Ø 125 mm Tépőzárás rögzítés / prindere prin piulita	11



GUMITÁNYÉR SAROKKÖSZÖRŰHÖZ  
SUPORT PENTRU DISC VELCRO



22044	Ø 125 mm, M14, Tépőzárás rögzítés, sarok köszörű prindere prin piulita, pentru polizor unghiular	15
22060	Ø 150 mm, M14, Tépőzárás rögzítés, sarok köszörű prindere prin piulita, pentru polizor unghiular	6



GUMITÁNYÉR CSAPOS  
SUPORT PENTRU DISC VELCRO



22061 Ø 125 mm, Tépőzárás rögzítés / prindere prin piulita 5



POLÍROZÓKORONG TÉPŐZÁRAS  
DISC LUSTRIURE



22065	Ø 125 mm, na čičak	20
22066	Ø 150 mm, na čičak	20

40% PES  
60% COTON



**POLÍROZÓKORONG TÉPŐZÁRAS**  
DISC LUSTRIRE



40% **PES**  
60% **COTON**

**22068** Ø 125 mm  
**22069** Ø 150 mm

20  
20

**POLÍROZÓKORONG TÉPŐZÁRAS**  
DISC LUSTRIRE



**22070** Ø 115 mm, se suchým zipem/bind with velcro  
**22071** Ø 125 mm, se suchým zipem/bind with velcro  
**22072** Ø 150 mm, se suchým zipem/bind with velcro

20  
20  
20

**CSISZOLÓTÁRCSA TÉPŐZÁRAS Ø 125 MM**  
DISCURI ABRAZIVE VELCRO Ø 125 MM PRINDERE  
PRIN PIULITA



<b>22045</b> 3 db/buc, hr. 40	1	<b>22049</b> 3 db/buc, hr. 120	1
<b>22046</b> 3 db/buc, hr. 60	1	<b>22050</b> 3 db/buc, hr. 150	1
<b>22047</b> 3 db/buc, hr. 80	1	<b>22051</b> 3 db/buc, hr. 180	1
<b>22048</b> 3 db/buc, hr. 100	1	<b>22052</b> 3 db/buc, hr. 220	1

**CSISZOLÓTÁRCSA TÉPŐZÁRAS Ø 150 MM**  
DISCURI ABRAZIVE VELCRO Ø 150 MM PRINDERE  
PRIN PIULITA



<b>22053</b> 3 db/buc, hr. 40	1	<b>22056</b> 3 db/buc, hr. 100	1
<b>22054</b> 3 db/buc, hr. 60	1	<b>22057</b> 3 db/buc, hr. 120	1
<b>22055</b> 3 db/buc, hr. 80	1		

**FIBER DISK Ø125 MM**  
FIBER DISK Ø125 MM

**NEW**

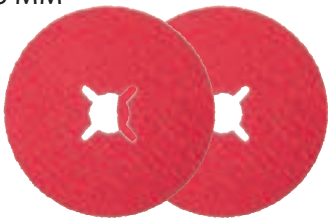

<b>22160</b> hr. 40 3 db/buc	1	<b>22163</b> hr. 100 3 db/buc	1
<b>22161</b> hr. 60 3 db/buc	1	<b>22164</b> hr. 120 3 db/buc	1
<b>22162</b> hr. 80 3 db/buc	1		

**FIBER DISK Ø150 MM**  
FIBER DISK Ø150 MM

**NEW**

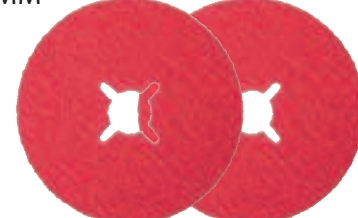

<b>22165</b> hr. 40 3 db/buc	1	<b>22168</b> hr. 100 3 db/buc	1
<b>22166</b> hr. 60 3 db/buc	1	<b>22169</b> hr. 120 3 db/buc	1
<b>22167</b> hr. 80 3 db/buc	1		

**CSISZOLÓTÁRCSA TÉPŐZÁRAS**  
DISCURI ABRAZIVE VELCRO



<b>22096</b> Ø 125 mm, P40	20
<b>22097</b> Ø 125 mm, P60	20
<b>22098</b> Ø 125 mm, P80	20
<b>22099</b> Ø 125 mm, P120	20

**CSISZOLÓVÁSZON 230X280 MM**  
PANZA ABRAZIVA 230X280 MM



<b>21732</b> 10 db/buc, hr. 40	25	<b>21736</b> 10 db/buc, hr. 100	50
<b>21734</b> 10 db/buc, hr. 60	25	<b>21737</b> 10 db/buc, hr. 120	50
<b>21735</b> 10 db/buc, hr. 80	25		

**CSISZOLÓPAPÍR VÍZÁLLÓ 230X280 MM**  
HARTIE ABRAZIVA HIDROREZISTENTA 230X280 MM



<b>21701</b> 10 ks/pcs, hr. 60	50	<b>21704</b> 10 db/buc, hr. 12050	
<b>21702</b> 10 ks/pcs, hr. 80	50	<b>21705</b> 10 db/buc, hr. 15050	
<b>21703</b> 10 ks/pcs, hr. 100	50	<b>21706</b> 10 db/buc, hr. 18050	
		<b>21709</b> 10 db/buc, hr. 24050	

**CSISZOLÓPAPÍR 230X280 MM**  
HARTIE ABRAZIVA 230X280 MM

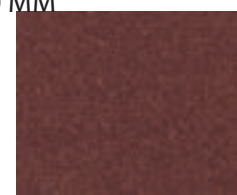

<b>21715</b> 10 db/buc, hr. 40	50	<b>21719</b> 10 db/buc, hr. 12050	
<b>21716</b> 10 db/buc, hr. 60	50	<b>21720</b> 10 db/buc, hr. 15050	
<b>21717</b> 10 db/buc, hr. 80	50	<b>21721</b> 10 db/buc, hr. 18050	
<b>21718</b> 10 db/buc, hr. 100	50	<b>21724</b> 10 db/buc, hr. 24050	

CSISZOLÓVÁSZON 8 LYUKU 93X230 MM  
HARTIE ABRAZIVA 93X230 MM



8 otvorú B/D



<b>21740</b>	5 db/buc, P40	20
<b>21741</b>	5 db/buc, P60	20
<b>21742</b>	5 db/buc, P80	20
<b>21743</b>	5 db/buc, P100	20
<b>21744</b>	5 db/buc, P120	20

CSISZOLÓVÁSZON 10 LYUKU 115X280 MM  
HARTIE ABRAZIVA 115X280 MM



10 otvorú



<b>21750</b>	5 db/buc, P40	20
<b>21751</b>	5 db/buc, P60	20
<b>21752</b>	5 db/buc, P80	20
<b>21753</b>	5 db/buc, P100	20
<b>21754</b>	5 db/buc, P120	20

CSISZOLÓ SZIVACS 100x70x25 mm  
BURETE ABRAZIV 100x70x25 mm

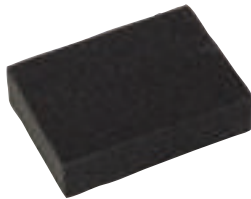

<b>22100</b>	P60	1
<b>22101</b>	P80	1
<b>22102</b>	P100	1
<b>22103</b>	P120	1
<b>22104</b>	P180	1
<b>22105</b>	P220	1

CSISZOLÓ SZIVACS 120x95x10 mm  
BURETE ABRAZIV 120x95x10 mm

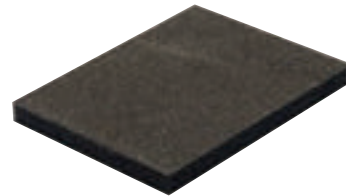

<b>22110</b>	P80	1
<b>22111</b>	P120	1
<b>22112</b>	P180	1
<b>22113</b>	P220	1

CSISZOLÓ TUSKÓ  
SUPORT CAUCIUC



<b>22075</b>	210 x 105 mm	plastic	60
<b>22076</b>	160 x 85 mm	plastic	60

CSISZOLÓ TUSKÓ  
SUPORT CAUCIUC



<b>22077</b>	125 x 68 mm	gumi/cauciuc	60
--------------	-------------	--------------	----

GIPSKARTON GYALU  
RAZUITOARE GIPS-CARTON



22120 250 x 40 mm



6

GIPSKARTON GYALU  
RAZUITOARE GIPS-CARTON



22121 250 x 40 mm



6

GIPSKARTON GYALU  
RAZUITOARE GIPS-CARTON



22122 140 x 40 mm



6

GIPSKARTON GYALU  
RAZUITOARE GIPS-CARTON



22123 60 x 40 mm



8

GIPSKARTON GYALU  
RAZUITOARE GIPS-CARTON



22124 Ø 16 x 250 mm



10

GIPSKARTON GYALU  
RAZUITOARE GIPS-CARTON



22125 250 x 40 mm



6

VÁGÓ TÁJOLÓ GIPSKARTON  
TAIERE PENTRU GIPS-CARTON COMPASS

NEW



24191



1

GIPSKARTON GYALU  
RINDEA GIPSCARTON



34315



1

GIPSKARTON LYUKFÚRÓ  
FREZE TAIERE GIPSCARTON



24190 270 mm



10

TART. KÉSEK GIPSKART. GYALUHOZ  
REZERVE PENTRU RAZUITOARE



22130 250 x 40 mm  
22132 140 x 40 mm  
22133 60 x 40 mm  
22134 Ø 16 x 250 mm



20

20

20

20



LAPOS FÉMRESZELŐ  
PILA DREAPTA

FESTA®



Vastagság/rugozitate 2



22180 250 mm

GÖMBÖLYŰ FÉMRESZELŐ  
PILA ROTUNDA

FESTA®



Vastagság/rugozitate 2



22181 250 mm

FÉLGÖMBÖLYŰ FÉMRESZELŐ  
PILA SEMIROTUNDA

FESTA®



Vastagság/rugozitate 2



22182 250 mm

HÁROMSZÖGŰ FÉMRESZELŐ  
PILA TRIUNGHIULARA

FESTA®



Vastagság/rugozitate 2



22183 250 mm

NÉGYSZÖGŰ FÉMRESZELŐ  
PILA PATRATA

FESTA®



Vastagság/rugozitate 2



22184 250 mm

HÁROMSZÖGŰ RESZELŐ  
PILA TRIUNGHIULARA

FESTA®



Vastagság/rugozitate 1



22178 150 mm

FÉMRESZELŐ KÉSZLET  
PILE SET

FESTA®

Vastagság 2  
rugozitate 2

22185 3 db/buc, 250 mm

30

FÉMRESZELŐ KÉSZLET  
PILE SET

FESTA®

Vastagság 2  
rugozitate 2

22186 5 db/buc, 250 mm

20

TŰRESZELŐ  
SET PILE FINE

FESTA®



22188 10 db/buc

20

GYÉMÁNT RESZELŐ  
SET PILE DIAMANTATE

FESTA®

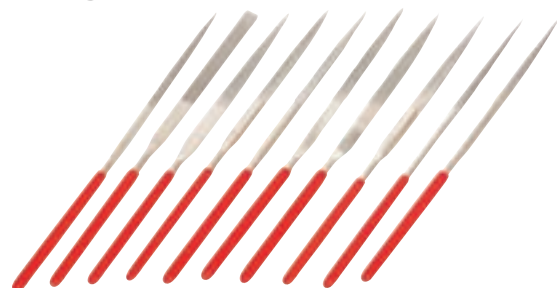

22189 10 db/buc

10

LÁNCFŰRÉSZ RESZELŐ  
PILA PENTRU LANT DE FERASTRAU

FESTA®



22170	200 mm	3,5 mm	20
22171	200 mm	4 mm	10
22172	200 mm	4,5 mm	10
22173	200 mm	5 mm	10
22174	200 mm	5,5 mm	10

RÁSPOLY  
RASPILE

FESTA®



22198	300 mm	6
-------	--------	---

RÁSPOLY  
RASPILE

FESTA®



22197	300 mm	6
-------	--------	---

RÁSPOLY KÉSZLET  
RAZUITOARE GIPS-CARTON

FESTA®



22195	3 db/buc, 300 mm	10
-------	------------------	----

RÁSPOLY  
RASPILE

FESTA®



22199	300 mm	6
-------	--------	---

LÁNCFŰRÉSZ RESZELŐ ADAPTER  
ADAPTOR PENTRU ASCUTIT CU PILA

FESTA®

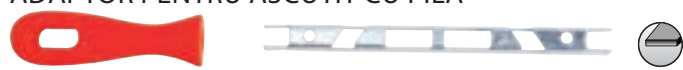

Ø 4 mm



22190		6
-------	--	---

KÖRFŰRÉSZ TÁRCSA, VIDIA LAPPAL TCT  
PANZA CIRCULAR TCT



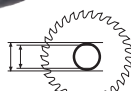

FESTA®



22300	Ø 115 / Ø22 mm / 40z	10
22301	Ø 125 / Ø22 mm / 40z	10
22302	Ø 140 / Ø20 mm / 24z	10
22303	Ø 140 / Ø20 mm / 30z	10
22305	Ø 150 / Ø20 mm / 24z	10
22307	Ø 160 / Ø20 mm / 18z	10
22309	Ø 160 / Ø20 mm / 24z	10
22310	Ø 160 / Ø20 mm / 30z	10
22311	Ø 160 / Ø20 mm / 36z	10
22312	Ø 160 / Ø20 mm / 48z	10
22313	Ø 160 / Ø20 mm / 60z	15
22315	Ø 180 / Ø30 mm / 24z	10
22317	Ø 180 / Ø30 mm / 50z	10
22318	Ø 180 / Ø20 mm / 50z	10
22319	Ø 190 / Ø20 mm / 40z	10
22320	Ø 190 / Ø30 mm / 40z	10
22322	Ø 200 / Ø30 mm / 24z	10
22324	Ø 200 / Ø30 mm / 40z	10
22326	Ø 200 / Ø30 mm / 60z	10



22328	Ø 205 / Ø30 mm / 40z	10
22329	Ø 205 / Ø30 mm / 60z	10
22332	Ø 210 / Ø30 mm / 40z	10
22333	Ø 210 / Ø30 mm / 60z	10
22335	Ø 250 / Ø30 mm / 40z	10
22337	Ø 250 / Ø30 mm / 60z	10
22340	Ø 300 / Ø30 mm / 40z	10
22343	Ø 300 / Ø30 mm / 60z	10
22345	Ø 300 / Ø30 mm / 96z	5
22350	Ø 350 / Ø30 mm / 40z	5
22351	Ø 350 / Ø30 mm / 54z	5
22355	Ø 400 / Ø30 mm / 40z	5
22357	Ø 400 / Ø30 mm / 60z	5
22365	Ø 500 / Ø30 mm / 60z	4
22370	Ø 600 / Ø30 mm / 60z	4
22398	redukcios gyuru/Inel reductie Ø30/Ø25 mm	1
22399	redukcios gyuru/Inel reductie Ø20/Ø16 mm	1

	TÉGLA / CARAMIDA	BEVONAT/ COATING	KŐ / PIATRA	KONKRÉT / BETON	VASBETON/ BETON ARMAT	STRÉŠNÍ TAŠKY / ROOF TILES	UVEG / STICLĀ	MÁRVÁNY / MARMURA	GRANIT/ GRANITE	HOMOKKO / GRESIE	ASFALT / ASPHALT	KVARC / CUARȚ
 <b>FESTA INDUSTRY</b>	√√	√√	√√	√√√	√√√	√√	—	√	√√√	√√	—	√√
 <b>TELJES/COMPLET</b>	√√	√√√	√√	√	—	√	√√√	√√	√√	—	√√	√
 <b>TURBO</b>	√√	√√	√√	√√√	√√√	√√	—	√	√√√	√√	—	√√
 <b>SEGMENT</b>	√√	—	√√	√√√	—	√√	—	√	√√	√√	√√	√

### GYÉMÁNT VÁGÓTÁRCSA DISC DIAMANTAT

**FESTA®  
INDUSTRY**

<b>21200</b>	Ø 115 mm	Ø 22,2 mm	10
<b>21201</b>	Ø 125 mm	Ø 22,2 mm	10
<b>21203</b>	Ø 230 mm	Ø 22,2 mm	10
<b>NEW 21204</b>	Ø 200 mm	Ø 25,4 mm	10

### GYÉMÁNT VÁGÓTÁRCSA FOLYTONOS DISC DIAMANTAT

**FESTA®**



<b>21210</b>	Ø 110/Ø22,2 mm	10
<b>21211</b>	Ø 115/Ø22,2 mm	10
<b>21212</b>	Ø 125/Ø22,2 mm	10
<b>21215</b>	Ø 150/Ø22,2 mm	10
<b>21218</b>	Ø 180/Ø22,2 mm	10
<b>21219</b>	Ø 180/Ø25,4 mm	10
<b>21220</b>	Ø 200/Ø25,4 mm	10
<b>21223</b>	Ø 230/Ø22,2 mm	10
<b>21224</b>	Ø 300/Ø25,4 mm	10

### GYÉMÁNT VÁGÓTÁRCSA SZEGMENTÁLT DISC DIAMANTAT

**FESTA®**

<b>21310</b>	Ø 110/Ø22,2 mm	10
<b>21311</b>	Ø 115/Ø22,2 mm	10
<b>21312</b>	Ø 125/Ø22,2 mm	10
<b>21315</b>	Ø 150/Ø22,2 mm	10
<b>21318</b>	Ø 180/Ø22,2 mm	10
<b>21323</b>	Ø 230/Ø22,2 mm	10
<b>21324</b>	Ø 300/Ø25,4 mm	10

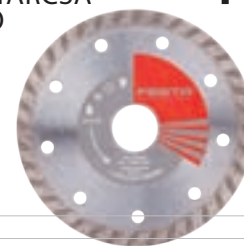
### TURBO GYÉMÁNT VÁGÓTÁRCSA DISC DIAMANTAT TURBO

**FESTA®**

<b>21410</b>	Ø 110/Ø22,2 mm	10
<b>21411</b>	Ø 115/Ø22,2 mm	10
<b>21412</b>	Ø 125/Ø22,2 mm	10
<b>21415</b>	Ø 150/Ø22,2 mm	10
<b>21418</b>	Ø 180/Ø22,2 mm	10
<b>21423</b>	Ø 230/Ø22,2 mm	10
<b>21424</b>	Ø 300/Ø25,4 mm	10

### GYÉMÁNT VÁGÓTÁRCSA FOLYTONOS DISC DIAMANTAT



<b>21010</b>	Ø 110/Ø22,2 mm	10
<b>21011</b>	Ø 115/Ø22,2 mm	10
<b>21012</b>	Ø 125/Ø22,2 mm	10
<b>21015</b>	Ø 150/Ø22,2 mm	10
<b>21018</b>	Ø 180/Ø22,2 mm	10
<b>21023</b>	Ø 230/Ø22,2 mm	10

### GYÉMÁNT VÁGÓTÁRCSA SZEGMENTÁLT DISC DIAMANTAT



<b>21110</b>	Ø 110/Ø22,2 mm	10
<b>21111</b>	Ø 115/Ø22,2 mm	10
<b>21112</b>	Ø 125/Ø22,2 mm	10
<b>21115</b>	Ø 150/Ø22,2 mm	10
<b>21118</b>	Ø 180/Ø22,2 mm	10
<b>21123</b>	Ø 230/Ø22,2 mm	10

### GYÉMÁNT VÁGÓTÁRCSA TURBO DISC DIAMANTAT TURBO



<b>21130</b>	Ø 110/Ø22,2 mm	10
<b>21135</b>	Ø 115/Ø22,2 mm	10
<b>21140</b>	Ø 125/Ø22,2 mm	10
<b>21150</b>	Ø 150/Ø22,2 mm	10
<b>21180</b>	Ø 180/Ø22,2 mm	10
<b>21190</b>	Ø 230/Ø22,2 mm	10

▼ GYÉMÁNT VÁGÓTÁRCSA  
DISC DIAMANTAT



21430	Ø 155/Ø22,2 mm	10
21431	Ø 125/Ø22,2 mm	10
21432	Ø 250/Ø22,2 mm	10



▼ GYÉMÁNT CSISZOLÓTÁRCSA  
DISC DIAMANTAT POLIZARE TURBO

FESTA®

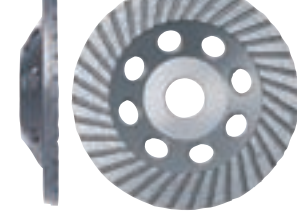

21425	Ø 100/Ø22,2 mm	5
21426	Ø 115/Ø22,2 mm	5
21427	Ø 125/Ø22,2 mm	5
21428	Ø 150/Ø22,2 mm	5



▼ FÉMVÁGÓ KORONG  
DISC TAIERE METAL

FESTA®  
INDUSTRY

pro nerez/for stainless steel



22260	Ø 115/Ø22,2 mm x 1 mm	1
22263	Ø 115/Ø22,2 mm x 1,6 mm	1
22264	Ø 115/Ø22,2 mm x 2 mm	1
22265	Ø 115/Ø22,2 mm x 2,5 mm	1
22266	Ø 125/Ø22,2 mm x 1 mm	1
22269	Ø 125/Ø22,2 mm x 1,6 mm	1
22270	Ø 125/Ø22,2 mm x 2 mm	1
22271	Ø 125/Ø22,2 mm x 2,5 mm	1
22273	Ø 150/Ø22,2 mm x 1,6 mm	1
22274	Ø 150/Ø22,2 mm x 2 mm	1
22275	Ø 150/Ø22,2 mm x 2,5 mm	1
22277	Ø 180/Ø22,2 mm x 2 mm	1
22278	Ø 180/Ø22,2 mm x 2,5 mm	1
22280	Ø 230/Ø22,2 mm x 2 mm	1
22281	Ø 230/Ø22,2 mm x 2,5 mm	1

▼ FÉMVÁGÓ KORONG  
DISC TAIERE METAL

FESTA®



22211	Ø 115/Ø22,2 mm x 1,0 mm	50
22212	Ø 115/Ø22,2 mm x 1,2 mm	50
22215	Ø 115/Ø22,2 mm x 2,0 mm	50
22216	Ø 115/Ø22,2 mm x 2,5 mm	50
22217	Ø 125/Ø22,2 mm x 1,2 mm	50
22218	Ø 125/Ø22,2 mm x 2,5 mm	50
22219	Ø 150/Ø22,2 mm x 1,2 mm	25
22220	Ø 150/Ø22,2 mm x 2,5 mm	25
22222	Ø 180/Ø22,2 mm x 2,5 mm	25
22224	Ø 230/Ø22,2 mm x 2,5 mm	25
22225	Ø 125/Ø22,2 mm x 1,0 mm	50
22251	Ø 115/Ø22,2 mm x 1,6 mm	50
22252	Ø 125/Ø22,2 mm x 1,6 mm	50
22253	Ø 150/Ø22,2 mm x 1,6 mm	25
22254	Ø 180/Ø22,2 mm x 1,6 mm	25
22255	Ø 230/Ø22,2 mm x 1,6 mm	25

▼ FÉM TISZTÍTÓ KORONG  
DISC POLIZARE METAL

FESTA®  
INDUSTRY

pro nerez/for stainless steel



22295	Ø 115/Ø22,2 mm x 6,4 mm	1
22296	Ø 125/Ø22,2 mm x 6,4 mm	1
22297	Ø 150/Ø22,2 mm x 6,4 mm	1
22298	Ø 180/Ø22,2 mm x 6,4 mm	1

▼ FÉM TISZTÍTÓ KORONG  
DISC POLIZARE METAL

FESTA®



22240	Ø 115/Ø22,2 mm x 6,4 mm	25
22242	Ø 125/Ø22,2 mm x 6,4 mm	25
22244	Ø 150/Ø22,2 mm x 6,4 mm	25
22246	Ø 180/Ø22,2 mm x 6,4 mm	25
22248	Ø 230/Ø22,2 mm x 6,4 mm	25

▼ KÖVÁGÓ KORONG  
DISC TAIERE PIATRA

FESTA®  
INDUSTRY

22290	Ø 115/Ø22,2 mm x 2,5 mm	1
22291	Ø 125/Ø22,2 mm x 2,5 mm	1
22292	Ø 150/Ø22,2 mm x 2,5 mm	1
22293	Ø 180/Ø22,2 mm x 2,5 mm	1
22294	Ø 230/Ø22,2 mm x 2,5 mm	1

▼ KÖVÁGÓ KORONG  
DISC TAIERE PIATRA

FESTA®



22230	Ø 115/Ø22,2 mm x 2,5 mm	50
22232	Ø 125/Ø22,2 mm x 2,5 mm	50
22234	Ø 150/Ø22,2 mm x 2,5 mm	25
22236	Ø 180/Ø22,2 mm x 2,5 mm	25
22238	Ø 230/Ø22,2 mm x 2,5 mm	25

LAMELLÁS TÁRCSA  
DISC LAMELAR FRONTAL

FESTA®

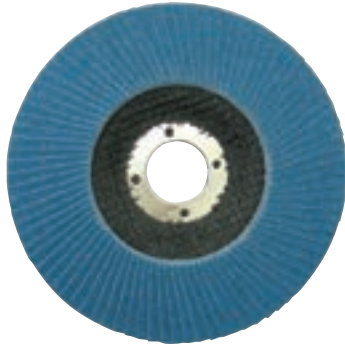

rozsdamentes acél csiszolásra / Pentru slefuire inox

22140	Ø 115/Ø22,2 mm hr. 40	20	
22141	Ø 115/Ø22,2 mm hr. 60	20	
22142	Ø 115/Ø22,2 mm hr. 80	20	
22143	Ø 115/Ø22,2 mm hr. 100	20	
22145	Ø 125/Ø22,2 mm hr. 40	20	
22146	Ø 125/Ø22,2 mm hr. 60	20	
22147	Ø 125/Ø22,2 mm hr. 80	20	
22148	Ø 125/Ø22,2 mm hr. 100	20	
22150	Ø 150/Ø22,2 mm hr. 40	10	
22151	Ø 150/Ø22,2 mm hr. 60	10	
22155	Ø 150/Ø22,2 mm hr. 80	10	
22156	Ø 150/Ø22,2 mm hr. 100	10	

LAMELLÁS TÁRCSA  
DISC LAMELAR FRONTAL



21780	Ø 115 mm, hr. 40	1	
21781	Ø 115 mm, hr. 60	1	
21782	Ø 115 mm, hr. 80	1	
21783	Ø 115 mm, hr. 100	1	
21784	Ø 115 mm, hr. 120	1	
21786	Ø 125 mm, hr. 40	1	
21787	Ø 125 mm, hr. 60	1	
21788	Ø 125 mm, hr. 80	1	
21789	Ø 125 mm, hr. 100	1	
21790	Ø 125 mm, hr. 120	1	
21792	Ø 150 mm, hr. 40	1	
21793	Ø 150 mm, hr. 60	1	
21794	Ø 150 mm, hr. 80	1	
21795	Ø 150 mm, hr. 100	1	
21796	Ø 150 mm, hr. 120	1	

DISC FA LYUKAK  
DISC PENTRU LEMN CU GĂURI

NEW



21800 Ø 125 x 22,2 mm



1

WOLFRAM BEVONATOS LEMEZ  
DISC DE ACOPERIRE WOLFRAMUL

NEW

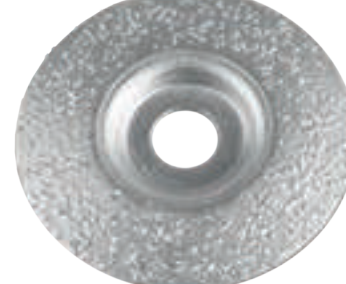

21805 Ø 115 x 22,2 mm



6

**Profi dekopirfűrészlapok**  
Németországban gyártott lézerkiégetéses technológiával







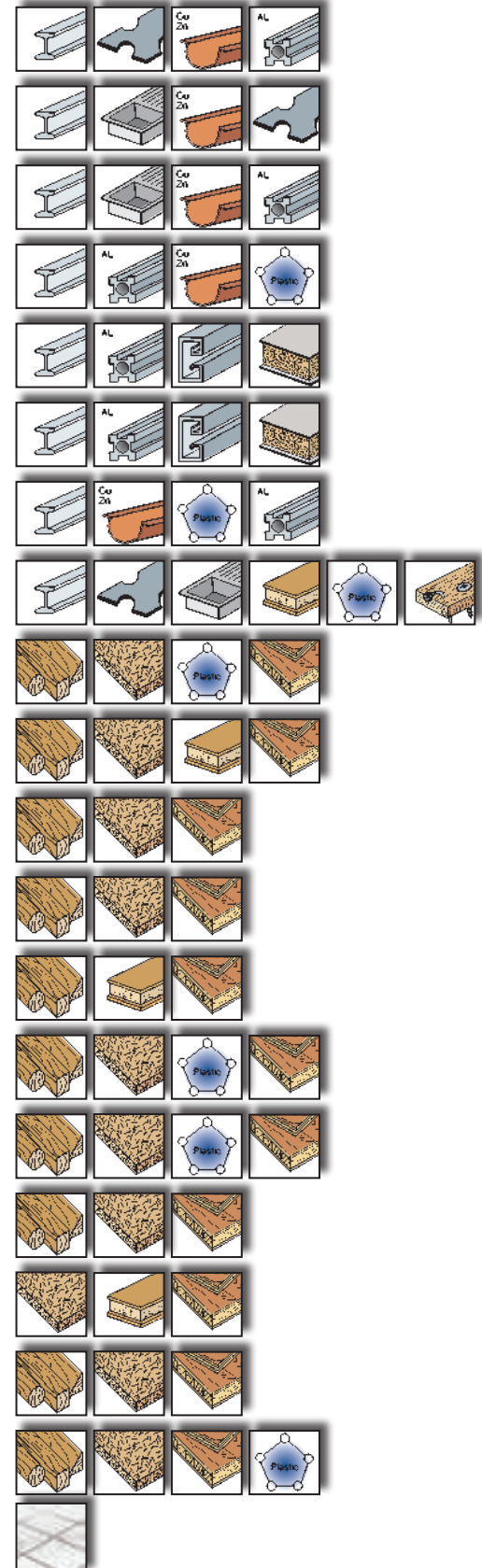

**lama profesionala de ferastrau**  
fabricat in Germania cu tehnologie laser

DEKOPIRFŰRÉS Z LAPOK, HSS (AEG, Bosch, Festo, Makita, Metabo)  
LAME DE FERASTRUU HSS (AEG, Bosch, Festo, Makita, Metabo)

	<b>24060</b>	50mm/1mm	0,7mm/36TPI	31007	5 db/buc	10	
	<b>24061</b>	50mm/1mm	1,2mm/21TPI	31012	5 db/buc	10	
	<b>24062</b>	50mm/1mm	2,0mm/13TPI	31020	5 db/buc	10	
	<b>24063</b>	75mm/1mm	3,0mm/8TPI	31030	5 db/buc	10	
	<b>24064</b>	100mm/1mm	1,2mm/21TPI	31112	5 db/buc	10	
	<b>24065</b>	100mm/1,3mm	2,0mm/13TPI	31120	5 db/buc	10	
	<b>24066</b>	75mm/1,45mm	2,0mm/13TPI	31220	5 db/buc	10	
	<b>24067</b>	120mm/1,3mm	1,8-2,4mm/10-14TPI	31528	5 db/buc	10	
	<b>24068</b>	75mm/1,45mm	2,5mm/10TPI	32225	5 db/buc	10	
	<b>24069</b>	75mm/1,45mm	4,0mm/6TPI	32240	5 db/buc	10	
	<b>24070</b>	75mm/1,3mm	4,0mm/6TPI	32340	5 db/buc	10	
	<b>24071</b>	75mm/1,3mm	4,0mm/6TPI	32440	5 db/buc	10	
	<b>24072</b>	75mm/1,45mm	2,5mm/10TPI	32625	5 db/buc	10	
	<b>24073</b>	85mm/1,45mm	3,0mm/8TPI	32730	5 db/buc	10	
	<b>24074</b>	85mm/1,45mm	4,0mm/6TPI	32740	5 db/buc	10	
	<b>24075</b>	75mm/1,45mm	2,5/1,2mm/10/21TPI	32825	5 db/buc	10	
	<b>24076</b>	75mm/1,7mm	4,0mm/6TPI	32940	5 db/buc	10	
	<b>24077</b>	120mm/1,3mm	4,0mm/6TPI	33040	5 db/buc	10	
	<b>24078</b>	105mm/1,45mm	4,0mm/6TPI	34040	5 db/buc	10	
	<b>24055</b>	55mm	karbid/carbura		5 db/buc	20	



**DEKOPIRFŰRÉSZ LAPOK, HSS (Black & Decker, Skil)**  
**LAME DE FERASTRU HSS (Black & Decker, Skil)**

	<b>24080</b>	50mm/1,0mm	1,2mm/21TPI	11012	5 db/buc	10	
	<b>24081</b>	75mm/1,0mm	3,0mm/8TPI	11030	5 db/buc	10	
	<b>24082</b>	75mm/1,45mm	2,5mm/10TPI	12225	5 db/buc	10	
	<b>24083</b>	75mm/1,45mm	4mm/6TPI	12240	5 db/buc	10	
	<b>24084</b>	75mm/1,3mm	4,0mm/6TPI	12340	5 db/buc	10	
	<b>24085</b>	50mm/1,0mm	2,0mm/13TPI	12420	5 db/buc	10	
	<b>24086</b>	75mm/1,3mm	4,0mm/6TPI	12440	5 db/buc	10	
	<b>24087</b>	75mm/1,45mm	2,5mm/10TPI	12625	5 db/buc	10	

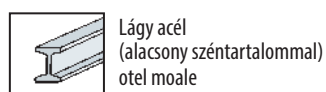
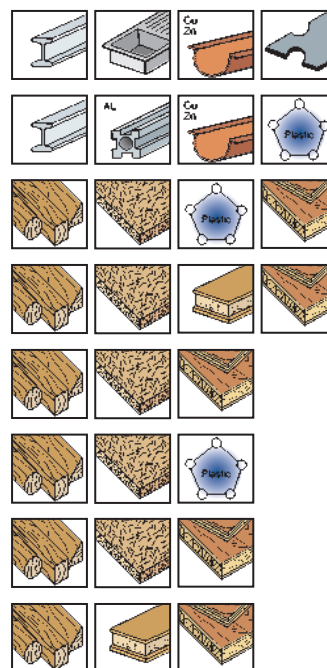
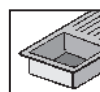
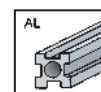
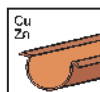
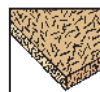
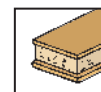
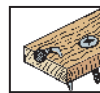
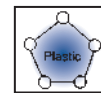
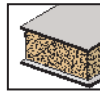
Lágy acél  
(alacsony széntartalommal)  
otel moaleAcéllemez  
foi de tablaRozsdamentes acél  
otel inoxidabilAL  
Aluminium  
aluminiumNem vastartalmú fémek  
metale neferoaseKemény- és puhafa  
lemn tare si moaleForgácsdeszka  
palFóliakaszított deszka  
pal melaminatFunérlemez  
placajLeces furnélemez  
panelSzögcséc  
scanduri cu cuieMűanyagok – plasztok  
plasticSzendvicsanyag  
material tip sandwichcsempére, kerámiához  
pavaj
**DEKOPIRFŰRÉSZ LAP ÁLLVÁNY**  
**STAND PENTRU LAME DE FERASTRU**

**24098**  
**tartalom/sumar:**

<b>24060</b>	5db/buc
<b>24080</b>	5db/buc
<b>24061</b>	3db/buc
<b>24062</b>	5db/buc
<b>24081</b>	5db/buc
<b>24063</b>	3db/buc
<b>24066</b>	5db/buc
<b>24067</b>	5db/buc
<b>24082</b>	5db/buc
<b>24068</b>	3db/buc
<b>24083</b>	5db/buc
<b>24069</b>	3db/buc
<b>24084</b>	5db/buc
<b>24070</b>	3db/buc
<b>24086</b>	5db/buc
<b>24071</b>	3db/buc
<b>24087</b>	5db/buc
<b>24072</b>	3db/buc
<b>24073</b>	5db/buc
<b>24074</b>	5db/buc
<b>24075</b>	5db/buc
<b>24076</b>	5db/buc

**24099** 64 x 50 cm - penge nélkül/sec  
**24098** 64 x 50 cm - pengével/brut

1

1

**SZŰRŐFŰRÉSZ LAP KLT.**  
**LAME DE FERASTRU, SET**

**24045** sada/set 5 db/buc

HOBBY



25

**DEKOPIRFŰRÉSZ LAPOK HS**  
**PANZA PENDULAR HS**

**24050** 203 mm

25

▼ FÉMFŰRÉSZ ERGONOMIKUS  
FERASTRAU PENTRU METALE

FESTA®



24104 300 mm



▼ FÉMFŰRÉSZ  
FERASTRAU PENTRU METALE

FESTA®



24102 300 mm



▼ FÉMFŰRÉSZ  
FERASTRAU PENTRU METALE



24103 300 mm



▼ FÉMFŰRÉSZ  
FERASTRAU PENTRU METALE



24153 300 mm



▼ FÉMFŰRÉSZ MŰA.NYÉLLEL  
FERASTRAU PENTRU METALE

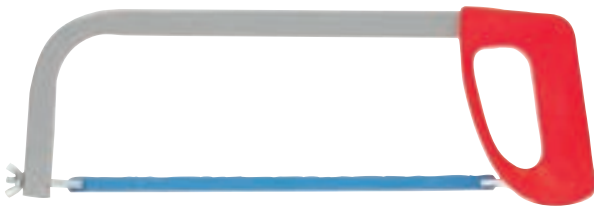

24100 300 mm



▼ FŰRÉSZKERET, FORGATHATÓ NYÉLLEL  
FERASTRAU PENTRU LEMN

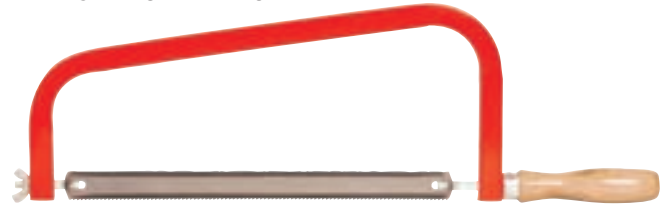

24170 300 mm



▼ KÉZI FŰRÉSZ  
FERASTRAU MANUAL



24125 150 mm



▼ METSZŐ FŰRÉSZ  
FERASTRAU CRENGI



24124 260 mm



▼ EGYKEZES ÁGFŰRÉSZ, FORG.  
FERASTRAU ARC MOBIL



24173 350 mm





**EGYKEZES ÁGVÁGÓFŰRÉSZ  
FERASTRAU PENTRU CRENGI**

<b>24141</b>	450 mm	24
<b>24140</b>	550 mm	24
<b>24135</b>	610 mm	24
<b>24136</b>	760 mm	24
<b>24142</b>	800 mm	24
<b>24137</b>	914 mm	24

**RÓKAFARK FŰRÉSZ  
FERASTRAU**

3x élezett, edzett fogazás  
3 randuri de dinti tratati termic

<b>24143</b>	300 mm	10
<b>24144</b>	400 mm	10
<b>24145</b>	500 mm	10

**ILLESZTŐ FŰRÉSZ  
FERASTRAU DE SLITUIT**

3x élezett, edzett fogazás  
3 randuri de dinti tratati termic

<b>24147</b>	300 mm	10
--------------	--------	----

**LYUKFŰRÉSZ  
FERASTRAU PENTRU LEMN SI PAL**

3x élezett, edzett fogazás  
3 randuri de dinti tratati termic

<b>24149</b>	300 mm	10
--------------	--------	----

**POKOSNICE  
MITER BOX**

<b>24171</b>	80 x 300 mm	50
--------------	-------------	----

**FŰRÉSZLAP ÁGVÁGÓBA  
LAMA DE FERASTRU**



<b>24185</b>	550 mm	1
<b>24186</b>	610 mm	1
<b>24187</b>	760 mm	1
<b>24188</b>	800 mm	1
<b>24189</b>	914 mm	1

**FŰRÉSZLAP ÁGVÁGÓBA  
LAMA DE FERASTRU**

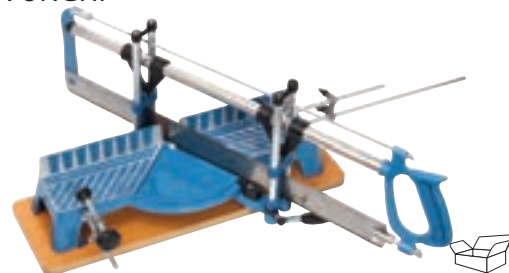

<b>24169</b>	350 mm	1
<b>24167</b>	450 mm	1
<b>24166</b>	550 mm	1
<b>24163</b>	610 mm	1
<b>24164</b>	760 mm	1
<b>24168</b>	800 mm	1
<b>24165</b>	914 mm	1

**ILLESZTŐ FŰRÉSZ  
FERASTRAU DE SLITUIT**

<b>24146</b>	300 mm	10
--------------	--------	----

**GHÉRVÁGÓ FŰRÉSZ  
FERASTRAU IN UNGHI**

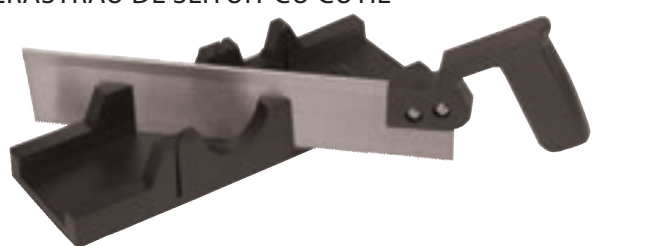
<b>24130</b>	600 mm	1
<b>24131</b>	600 mm, FŰRÉSZLAP / PANZA	1

**GÉRVÁGÓ FŰRÉSZ + LÁDA  
FERASTRAU DE SLITUIT CU CUTIE**

<b>24148</b>	300 mm	50
--------------	--------	----

▼ KERETES FAFŰRÉSZ  
FERASTRAU ARC PENTRU CRENGI

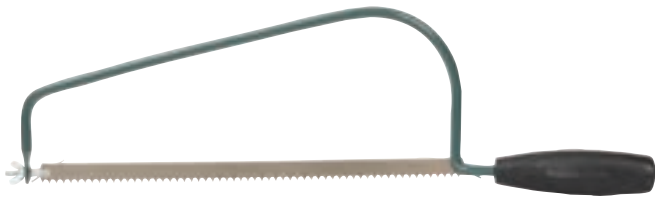

24151 300 mm



10

▼ GALLYAZÓ FŰRÉSZ  
FERASTRAU PENTRU CRENGI

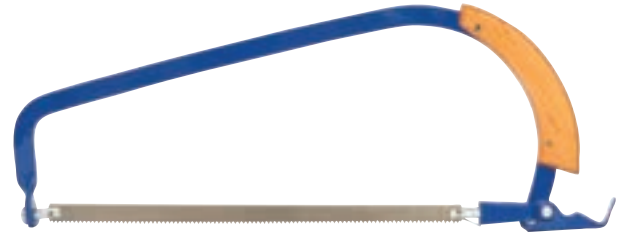

24150 300 mm



10

▼ GALLYAZÓ FŰRÉSZ  
FERASTRAU CRENGI



24154 300 mm



10

▼ POLYSTIROL FŰRÉSZ  
FERASTRAU PENTRU POLISTIREN



24174 370 mm



1

▼ GIPSKARTON FŰRÉSZ  
FERASTRAU GIPS-CARTON

**FESTA®**



24159 150 mm



15

▼ YTONG FŰRÉSZ  
FERASTRAU PENTRU POROTERM



24181 550 mm CZ



6

▼ YTONG FŰRÉSZ  
FERASTRAU PENTRU BCA



24158 22/22 SK fogú /dinti - 450 mm



6

▼ YTONG FŰRÉSZ  
FERASTRAU PENTRU BCA



24155 34/17 SK fogú /dinti - 630 mm

24156 34/34 SK fogú /dinti - 630 mm



2

▼ YTONG FŰRÉSZ  
FERASTRAU YTONG



24176 34/17 SK fogú /dinti - 750 mm

24177 34/34 SK fogú /dinti - 750 mm



6

6

▼ YTONG FŰRÉSZ  
FERASTRAU YTONG



24175 600 mm EU

24178 600 mm



6

6

▼ BECSUKHATÓ KERTFŰRÉSZ  
FERASTRAU PLIANT

FESTA®



3x élezett, edzett fogazás  
3 randuri de dinti tratati termic

45061 150 mm

6

▼ KERTIFŰRÉSZ TOKKAL  
FERASTRAU PLIANT

FESTA®



3x élezett, edzett fogazás  
3 randuri de dinti tratati termic

45062 260 mm, Tokkal/cu carcasa

24

▼ ÁGVÁGÓ FŰRÉSZ  
FERASTRAU TELESCOPIC



45030 Fém , fűrésszel/metal, cu ferastrau 30 cm 6

Teleszkopikus rúd/coada telescopica 240 cm

45031 Fém , fűrésszel/metal, cu ferastrau 30 cm 24

▼ ÁGVÁGÓ FŰRÉSZ  
FERASTRAU TELESCOPIC



45032 Fém, fűrészes nélkül/metal, fara ferastrau 30

▼ FŰRÉSZ  
FERASTRAU UNIVERSAL



INOX

24128 450 mm fűrészlapp / panza 24192

1

▼ BECSUKHATÓ KERTFŰRÉSZ  
FERASTRAU PLIANT

FESTA®



3x élezett, edzett fogazás  
3 randuri de dinti tratati termic

45060 180 mm

12

▼ TELESZKÓPOS ÁGVÁGÓ FŰRÉSZ  
FERASTRAU TELESCOPIC

FESTA®

3x élezett, edzett fogazás  
3 randuri de dinti tratati termic



45033 2,3-3,8 m

1

▼ ÍVES ÁGVÁGÓ FŰRÉSZ  
FERASTRAU PENTRU CRENGI

FESTA®



24152 350 mm

10

▼ FŰRÉSZLAP  
PANZA



24109 12,5 mm/300 mm Fémre /pentru metal 72

24118 25 mm/300 mm for metal, double sided 72

24119 25 mm/300 mm for metal and wood 72

FŰRÉSZLAP  
PANZA

FESTA®



24108 6 mm/150 mm na dřevo/for wood



1

CSERE FŰRÉSZLAP FOGAZÁS 300 MM  
PANZE FERA STRAU 300 MM

24160 Arasz/deschidere 3 mm / 300 mm



1

24161 Arasz/deschidere 4 mm / 300 mm

1

24162 Arasz/deschidere 5 mm / 300 mm

1

VÁGÓSZÁL GYÉMÁNTOS KERÁMIÁRA  
FIR CU CARBURA

24120 300 mm



50

BI-METAL FŰRÉSZLAP  
PANZA BI-METAL

24180 300 mm 24T 8% COBALT



100

FŰRÉSZLAP  
PANZA

24195 3 mm / 300 mm



1

24196 4 mm / 300 mm ferde fogazás/oblică dinti

1

24197 5 mm / 300 mm edzett fogazás/tratati termic

1

24192 450 mm, fűrés / ferastrau 24128

1

GLETTVAS ROZSDAMENTES 280x130 mm **FESTA®**  
 GLETIERA INOX CU MANER CAUCIUC 280x130 mm

Gumimarkolat/  
 maner de cauciuc



INOX



31140

GLETTVAS ROZSDAMENTES 280x130 mm **FESTA®**  
 GLETIERA INOX CU MANER CAUCIUC 280x130 mm

Gumimarkolat/  
 maner de cauciuc



INOX



31141 e4  
 31142 e6  
 31143 e8  
 31144 e10  
 31145 e12

10  
 10  
 10  
 10  
 10

GLETTVAS ROZSDAMENTES 280x130 mm **FESTA®**  
 GLETIERA INOX CU MANER CAUCIUC 280x130 mm

Gumimarkolat/  
 maner de cauciuc

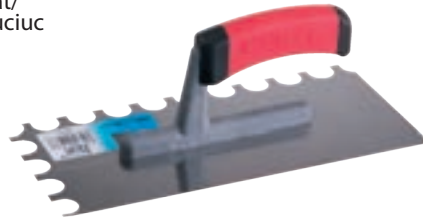

INOX



31146 O16

GLETTVAS ROZSDAMENTES 280x130 mm **FESTA®**  
 GLETIERA INOX 280x130 mm



INOX



31091

GLETTVAS ROZSDAMENTES 280x130 mm **FESTA®**  
 GLETIERA INOX 280 x 130 mm



INOX



31101 e4  
 31111 e6  
 31121 e8  
 31131 e10

10  
 10  
 10  
 10

GLETTVAS ROZSDAMENTES 280x130 mm **FESTA®**  
 GLETIERA INOX 280x130 mm



INOX



31011

GLETTVAS ROZSDAMENTES 280x130 mm **FESTA®**  
 GLETIERA INOX 280x130 mm



INOX



31021 e4  
 31031 e6  
 31041 e8  
 31051 e10

24  
 24  
 24  
 24

GLETTVAS ROZSDAMENTES 270x125 mm **FESTA®**  
 GLETIERA INOX 270x125 mm

NEW



INOX



31005

GLETTVAS ROZSDAMENTES 270x125 mm **FESTA®**  
 GLETIERA INOX 270x125 mm

NEW



INOX



31006 e4  
 31007 e6  
 31008 e8  
 31009 e10

24  
 24  
 24  
 24

GLETTVAS ROZSDAMENTES **FESTA®**  
 GLETIERA INOX



INOX

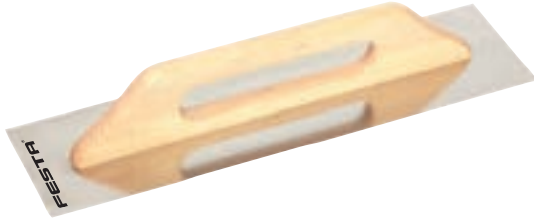

31151 360 x 130 mm EXTRA

GLETTVAS ROZSDAMENTES  
GLETIERA INOXFESTA®  

INOX



<b>31082</b>	480 x 130 mm EXTRA	10
<b>31150</b>	360 x 130 mm EXTRA	10

GLETTVAS ROZSDAMENTES 500x130 mm  
GLETIERA INOX 500x130 mm

FESTA®



INOX



<b>31052</b>	e 4	10
<b>31061</b>	e 6	10
<b>31062</b>	e 8	10
<b>31071</b>	e 10	10

GLETTVAS ROZSDAMENTES  
GLETIERA INOX

FESTA®



INOX



<b>31081</b>	500 x 130 mm	10
--------------	--------------	----

GLETTVAS ROZSDAMENTES  
GLETIERA INOX

FESTA®



INOX



<b>31155</b>	680 x 130 mm EXTRA	18
--------------	--------------------	----

ROZSDAMENTES KANÁL  
MISTRIE INOX

FESTA®



INOX



<b>31232</b>	120 mm	12
<b>31233</b>	140 mm	12
<b>31234</b>	160 mm	12
<b>31235</b>	180 mm	12

ROZSDAMENTES BÁDOGOS KANÁL  
MISTRIE PENTRU CHIT

FESTA®



INOX



<b>31320</b>	140 mm	12
--------------	--------	----

KÜLSŐSAROK KANÁL ROZSDAMENTES  
MISTRIE PENTRU COLT EXTERIOR

FESTA®



INOX



<b>31270</b>	40 mm	12
--------------	-------	----

BELSŐSAROK KANÁL ROZSDAMENTES  
MISTRIE PENTRU COLT INTERIOR

FESTA®



INOX



<b>31280</b>	80x60x60 mm	12
--------------	-------------	----

ROZSDAMENTES MACSKA NYELV KANÁL  
MISTRIE LIMBA DE PISICA

FESTA®



INOX



<b>31330</b>	140 mm	12
<b>31340</b>	160 mm	12

ROZSDAMENTES GIPSZELŐ KANÁL  
MISTRIE PENTRU CHIT

FESTA®



INOX



<b>31360</b>	40 mm	12
<b>31380</b>	60 mm	12
<b>31390</b>	80 mm	12
<b>31400</b>	100 mm	12
<b>31403</b>	120 mm	12

ROZSDAMENTES SPAKLI - KAPARÓ  
SPAÇLURI

FESTA®



INOX



31461	40 mm	12
31471	60 mm	12
31481	80 mm	12
31491	100 mm	12
31467	120 mm	12
31468	140 mm	12

ROZSDAMENTES KANÁL  
MISTRIE INOX

FESTA®



INOX



31220	120 x 80 mm	12
31221	140 x 80 mm	12
31222	160 x 115 mm	12
31231	180 x 120 mm	12

KÜLSŐSAROK KANÁL ROZSDAMENTES  
MISTRIE PENTRU COLT EXTERIOR

FESTA®



INOX



31271 80 x 60 x 60 mm

12

ROZSDAMENTES BÁDOGOS KANÁL  
MISTRIE PENTRU CHIT

FESTA®



INOX



31322 140 x 75 mm

12

ROZSDAMENTES SPAKLI  
SPAÇLU INOX

FESTA®



INOX



31510	40 mm	10
31511	60 mm	12
31512	80 mm	12
31513	100 mm	12
31514	120 mm	12
31515	140 mm	12

ROZSDAMENTES KANÁL  
MISTRIE INOX

FESTA®



INOX



31218 180 mm

12

ROZSDAMENTES GIPSZELŐ KANÁL  
MISTRIE PENTRU CHIT

FESTA®



INOX



31362	40 mm	12
31382	60 mm	12
31392	80 mm	12
31402	100 mm	12
31404	120 mm	12

BELSŐSAROK KANÁL ROZSDAMENTES  
MISTRIE PENTRU COLT INTERIOR

FESTA®



INOX



31281 80 x 60 x 60 mm

12

ROZSDAMENTES MACSKA NYELV KANÁL  
MISTRIE LIMBA DE PISICA

FESTA®



INOX



31332	140 x 50 mm	12
31341	160 x 60 mm	12

SPAKLI CSAVH. VÉGGEL  
SPAÇLURI + BIT

FESTA®

Cserélhető bit/  
bit înlocuibil

INOX



31455	150 mm	12
31456	200 mm	12

TÖBBFUNKCIÓS ROZSDAMENTES SPAKLI  
RAZUITOR ROSTURI **FESTA®**

INOX



31497

KITTKÉS  
CUTIT TAPET **FESTA®**

INOX



31503 150 mm

HOMLOKZATI ROZSDAMENTES SPAKLI  
SPACLU PENTRU FATADE **FESTA®**

INOX

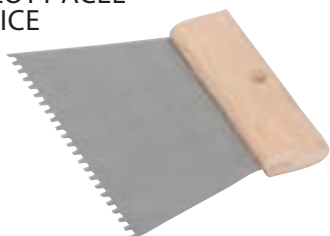
31541 250mm  
31551 250mm keskeny/ingust10  
10JAPÁN SPAKLI  
SET SPAKLURI JAPONEZE **FESTA®**31452 rozsdamentes/inox 50, 80, 100, 120 mm  
31453 acél/otel 50, 80, 100, 120 mm  
31454 plastic 50, 80, 100, 120 mm10  
10  
10SPATULA FOGAZOTT ACÉL  
SPAKLURI ELASTICE31641 180 mm - e4  
31655 250 mm - e4  
31601 180 mm - sima/sima  
31651 250 mm - sima/sima12  
12  
12  
12ROZSDAMENTES SPAKLI  
SPACLU INOX **FESTA®**

INOX

31498 150 mm  
31499 200 mm  
31500 100 mm12  
12  
12ROZSDAMENTES FESTÉKKAPARÓ  
SPACLU **FESTA®**

INOX

31493 40 mm  
31494 60 mm  
31495 80 mm  
31496 100 mm20  
20  
20  
20HOMLOKZATI ROZSDAMENTES SPAKLI  
SPACLU PENTRU FATADE **FESTA®**

INOX

31552 400 mm  
31553 600 mm10  
10KAPARÓ RIGIPS  
SPACLU RIGIPS **FESTA®**

INOX

31505 200 mm  
31506 250 mm  
31507 300 mm6  
6  
6FESTÉKKAPARÓ  
RAZUITOARE31501 100 mm  
31502 Pótpenge / Lame rezerva30  
1



KŐMŰVES KANÁL ACÉL  
MISTRIE OTEL

<b>32015</b>	160 x 130 mm	10
<b>32014</b>	180 x 130 mm	10
<b>32016</b>	200 x 140 mm	10

KŐMŰVES KANÁL ACÉL  
MISTRIE OTEL

<b>32001</b>	160 x 110mm	10
<b>32002</b>	160 x 130mm	10
<b>32003</b>	180 x 130mm	10
<b>32013</b>	200 x 140mm	10
<b>32018</b>	160 x 110 mm - Gömbölyű/rotunjít	10

FUGÁZÓKANÁL ACÉL  
MISTRIE

<b>32022</b>	140 x 20 mm	10
<b>32023</b>	125 x 40 mm	10

GIPSZELŐKANÁL ACÉL  
MISTRIE

<b>32024</b>	140 x 80 mm	10
--------------	-------------	----

BÁDOGOSKANÁL ACÉL  
MISTRIE

<b>32026</b>	140 x 95 mm	10
--------------	-------------	----

KŐMŰVES MACSKANYELV KANÁL ACÉL  
MISTRIE OTEL

<b>32020</b>	140 x 65 mm	10
<b>32021</b>	140 x 40 mm	10

SPAKLI ACÉL  
SPAFLURI OTEL

<b>32176</b>	30 mm	12
<b>32186</b>	40 mm	12
<b>32196</b>	50 mm	12
<b>32206</b>	60 mm	12
<b>32216</b>	80 mm	12
<b>32226</b>	100 mm	12
<b>32234</b>	125 mm	12

ACÉL SPAKLI - KAPARÓ KÉSZLET  
SET SPAFLURI

<b>32240</b>	30, 50, 80 mm, 3db/buc	10
--------------	------------------------	----

SPAKLI ACÉL  
SPAFLURI OTEL

<b>32161</b>	30 mm	12	<b>32165</b>	80 mm	12
<b>32162</b>	40 mm	12	<b>32171</b>	90 mm	12
<b>32163</b>	50 mm	12	<b>32166</b>	100 mm	12
<b>32164</b>	60 mm	12	<b>32172</b>	110 mm	12
<b>32169</b>	70 mm	12	<b>32167</b>	120 mm	12
			<b>32168</b>	140 mm	12



FESTA®

PADLÓSZÖNYEG KAPARÓ, NYELEZHETŐ  
RAZUITOR, MARGINE ASCUTITA

<b>32170</b>	100 mm	12
--------------	--------	----

nyél 52010 / maner 52010



**FUGÁZÓ KANÁL**  
**MISTRIE PENTRU IMBINARI**

<b>32040</b>	10 mm	10
<b>32041</b>	12 mm	10
<b>32042</b>	15 mm	10
<b>32043</b>	18 mm	10
<b>32044</b>	20 mm	10

**FUGÁZÓ**  
**MISTRIE PENTRU IMBINARI, DOUA CANTURI**

<b>32050</b>	10/12 mm	10
<b>32051</b>	10/15 mm	10
<b>32052</b>	10/18 mm	10
<b>32053</b>	15/20 mm	10

**KŐMŰVES SERPENYŐ**  
**CANCIOC**

<b>32273</b>	Ø 160 mm	10
<b>32283</b>	Ø 180 mm	10
<b>32293</b>	Ø 215 mm	10

**HORONYMARÓ YTONGHOZ**  
**DISPOZITIV PENTRU SCOBITURI**

**32037** 600 mm

18

**KŐMŰVES SERPENYŐ, HORGANYZOTT**  
**CANCIOG INOXIDABIL**

**32285** Ø 180 mm

INOX



10

**KŐMŰVES SERPENYŐ, POZINK MARKOLAT**  
**CANCIOG ZINCAT**

**32265** Ø 180 mm

Zn



10

**HABARCSMERŐ**  
**CANCIOC**

 es nyél átmérő/maner  
 Ø30mm

<b>32302</b>	Ø 180 mm	10
<b>32313</b>	Ø 215 mm	10
<b>32301</b>	Ø 235 mm	10

**KŐMŰVES SERPENYŐ MŰANYAG**  
**CANCIOC PLASTIC**

**32270** Ø 160 mm

10

**HABARCSMERŐ, HORGANYZOTT**  
**CANCIOG**

es nyél átmérő/maner Ø38mm

<b>32268</b>	Ø215 mm	10
<b>32269</b>	Ø235 mm	10
<b>32296</b>	Ø215 mm	10

**HABARCSMERŐ, HORGANYZOTT**  
**CANCIOG**

es nyél átmérő/maner Ø38mm

<b>32295</b>	Ø180 mm	fogantyú/maner	160 cm	5
<b>32297</b>	Ø215 mm	fogantyú/maner	160 cm	5
<b>32298</b>	Ø235 mm	fogantyú/maner	160 cm	5



YTONG KAPARÓ  
GLETIERA RAZUIITORFESTA®  

32317 450 x 95 mm

YTONG KAPARÓ  
GLETIERA YTONGFESTA®  

32337 260 x 95mm

VAKOLATGYALU FA  
GLETIERAFESTA®  

32327 220 x 140 mm

KAPARÓ  
GLETIERAFESTA®  

32325 210 x 105 mm

KAPARÓ RÉGI VAKOLATRA  
GLETIERA RAZUIITORFESTA®  

32314 400 x 180 mm

KAPARÓ RÉGI VAKOLATRA  
GLETIERA RAZUIITORFESTA®  



32329 270 x 130 mm

KAPARÓ RÉGI VAKOLATRA  
GLETIERA RAZUIITORFESTA®  

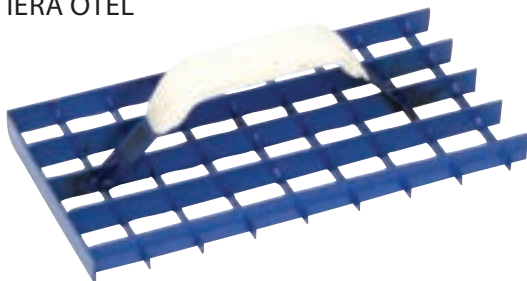

33169 380 x 160 mm, s otvory/with holes

KAPARÓ RÉGI VAKOLATRA  
GLETIERA RAZUIITOR CU LAMEFESTA®  

32320 dřevo/wood 400 x 180 mm

VAKALATGYALU RÁCSOS  
GLETIERA OTEL

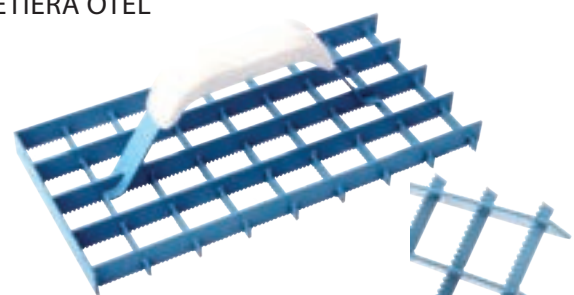
32316 280 x 150 mm

VAKALATGYALU RÁCSOS  
GLETIERA OTEL

32335 290 x 145 mm

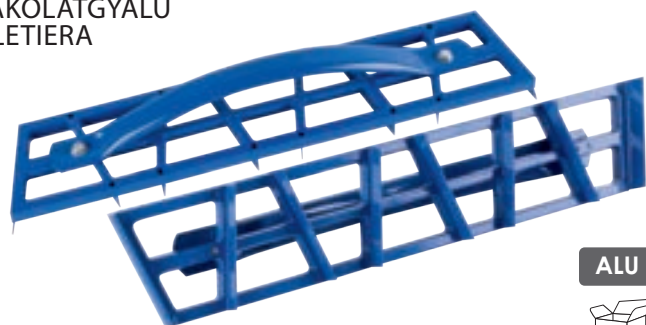

VAKOLATGYALU  
GLETIERA

ALU



32326 450 x 90 mm

6

VAKOLATGYALU MŰANYAG  
GLETIERA RAZUITOR CU LAME

32315 6 - pengevel / 6 lame



30

STYROPOR CSISZOLÓ  
SLEFUITOR POLISTIREN

FESTA®



32318 400 x 180 mm

1

32319 500 x 250 mm

1

32321 400 x 180 mm hr. 16 Csiszoló pótlap /Hartie abraziva

50

32322 500 x 250 mm hr. 16 Csiszoló pótlap /Hartie abraziva

50

STYROPOR CSISZOLÓ PLASTIC  
SLEFUITOR POLISTIREN PLASTIC

FESTA®



32324 270 x 130 mm hr. 16

40

32323 270 x 130 mm hr. 16 Csiszoló pótlap /Hartie abraziva

50

STYROPOR CSISZOLÓ PLASTIC  
GLETIERE PLASTIC CU ABRAZIV

FESTA®



32330 400 x 180 mm

1

32331 270 x 130 mm

1

MŰANYAG SIMÍTÓ ERŐSÍTETT  
GLETIERA PLASTIC

FESTA®



34027 400 x 180 mm

50

FA SIMÍTÓ  
GLETIERA LEMN

FESTA®



34005 400 x 150 mm

30

FA SIMÍTÓ  
GLETIERA LEMN

FESTA®



34007 290 x 140 mm

40

34008 250 x 120 mm

40

34010 450 x 145 mm

20

34012 450 x 70 mm

35

ACÉLSIMÍTÓ  
GLETIERA ASCUTITA

32076 400 x 100 mm

36

32060 500 x 140 mm

36

32062 280 x 160 mm

36

ACÉLSIMÍTÓ ,HEGYES  
GLETIERA ASCUTITA

32064 500 x 90 mm

36

32066 550 x 140 mm

36

MŰANYAG SIMÍTÓ ERŐSÍTETT  
GLETIERA ROSTURI

34033 240 x 95 mm



1

MŰANYAG SIMÍTÓ ABS  
GLETIERA ABS

FESTA®

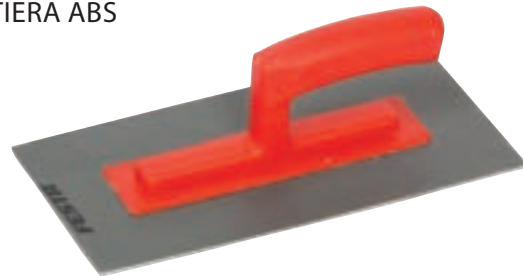
34041 280 x 140 - 2 mm  
34051 280 x 140 - 3 mm  
34053 280 x 140 - 3 mm - e610  
10  
10MŰANYAG CSISZOLÓ  
GLETIERA CU SUPRAFETE CURATARE

34495 250 x 130 x 20 mm



25

MŰANYAG SIMÍTÓ ERŐSÍTETT  
GLETIERA PLASTIC

FESTA®

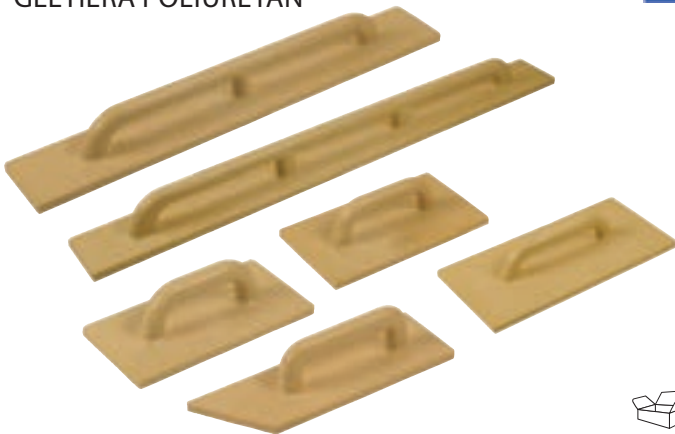
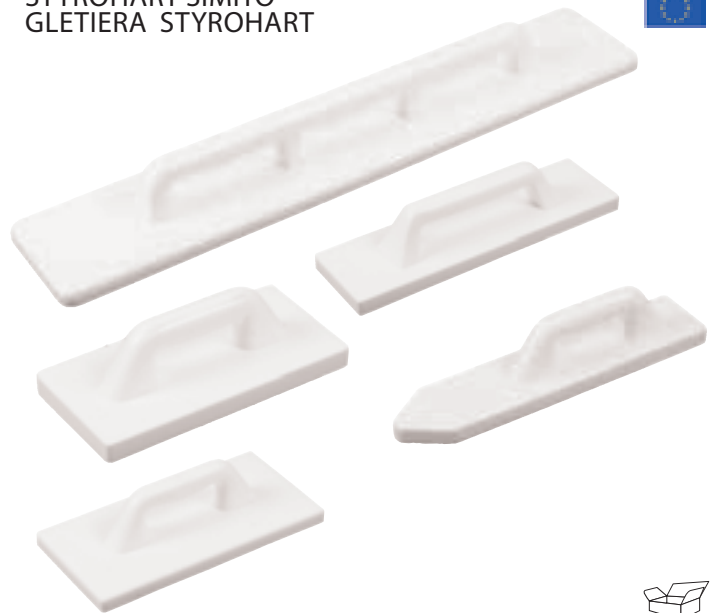
30003 270 x 125 mm  
30004 235 x 115 mm  
30005 205 x 115 mm  
30007 205 x 60 mm40  
40  
40  
40PUR SIMÍTÓ  
GLETIERA POLIURETAN34122 120 x 240 mm  
34132 140 x 280 mm  
34142 180 x 320 mm  
34152 200 x 360 mm  
34121 80 x 260 mm tesit  
34153 100 x 400 mm  
34154 220 x 420 mm  
34155 240 x 480 mm  
34156 280 x 500 mm  
34157 330 x 330 mm  
34158 120 x 800 mm  
34159 120 x 1000 mm  
34160 120 x 1200 mm50  
40  
25  
20  
50  
30  
15  
15  
10  
5  
5  
5  
5STYROHART SIMÍTÓ  
GLETIERA STYROHART34061 140 x 280 mm  
34071 140 x 450 mm  
34081 140 x 750 mm  
34091 140 x 900 mm  
34101 80 x 350 mm tesit  
34111 180 x 320 mm10  
10  
10  
5  
10  
10PUR SIMÍTÓ  
GLETIERA POLIURETAN34115 140 x 280 mm 36  
34116 180 x 320 mm 36  
34117 200 x 360 mm 24  
NEW 34118 220 x 420 mm 24  
NEW 34119 240 x 480 mm 2424  
24CSISZOLÓTUSKÓ GYORSRÖGZÍTŐS  
SUPPORT PENTRU SLEFUIT34301 235 x 105 mm  
34304 235 x 80 mm50  
50

CSISZOLÓ TUSKÓ CSAVAROS  
SUPPORT PENTRU SLEFUIT



<b>34200</b>	210 x 115 mm	30
<b>34201</b>	230 x 105 mm	10
<b>34202</b>	230 x 80 mm	10



CSISZOLÓ TUSKÓ NYELEZHETŐ  
SUPPORT CU ARTICULATIE MOBILA



<b>34203</b>	230 x 80 mm aluminiu	12
<b>52030</b>	Teleskopikus rúd/coada telescopica	12



CSISZOLÓ RÁCS 10 DB  
PLASA ABRAZIVA 10 BUC



<b>34271</b>	115 x 290 - zrn. 120	100
<b>34272</b>	115 x 290 - zrn. 100	100
<b>34273</b>	115 x 290 - zrn. 80	100
<b>34274</b>	93 x 290 - zrn. 120	100
<b>34275</b>	93 x 290 - zrn. 100	100
<b>34276</b>	93 x 290 - zrn. 80	100



CSISZOLÓ RÁCS 3 DB  
PLASA ABRAZIVA 3 BUC



<b>34280</b>	115 x 290 - zrn. 120	100
<b>34281</b>	115 x 290 - zrn. 100	100
<b>34282</b>	115 x 290 - zrn. 80	100
<b>34283</b>	93 x 290 - zrn. 120	100
<b>34284</b>	93 x 290 - zrn. 100	100
<b>34285</b>	93 x 290 - zrn. 80	100



GIPSKARTONÓZÓ SPATULA  
SPACLU PENTRU GIPS



<b>34305</b>	150 mm	12
<b>34306</b>	100 mm	12
<b>34307</b>	80 mm	12
<b>34308</b>	40 mm	12



LEHÚZÓGUMI  
UNEALTA PENTRU INTINS



<b>15886</b>	45 cm	nyél / maner Ø 23 mm	30
<b>15887</b>	60 cm	nyél / maner Ø 23 mm	30
<b>15888</b>	75 cm	nyél / maner Ø 23 mm	30



LEHÚZÓLÉC  
TAVA NIVELARE BETON



<b>15889</b>	98 x 38 cm	nyél / maner Ø 32 mm	20
--------------	------------	----------------------	----



LEHÚZÓLÉC  
UNEALTA PENTRU INTINS

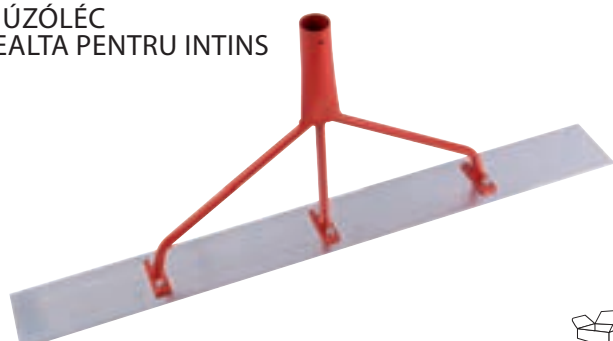

<b>15885</b>	80 cm	nyél / maner Ø 30 mm	40
--------------	-------	----------------------	----



GIPSKARTONÓZÓ SZETT, KOMPLET KLT.  
SET PENTRU GIPS



<b>34300</b>	Gipszkartonkészlet/ komplet/complet	10
<b>34303</b>	Kádacska/vas	48



VAKOLÓ HENGER  
ROLA TRANSFER



<b>32080</b>	25cm	1
<b>32081</b>	30cm	1



SIMÍTÓK HASZNÁLATA  
APLICATIILE GLETIERELOR

FELÜLET SUPRAFATA	ANYAG MATERIAL		VAKOLAT TENCUIALA				RAGASZTÓK ES FUGÁZÓ ANYAGOK MATERIAL ADEZIV SAU DE IMBINARE	HOMLOKZATI RAGASZTÓ FINISARI FATADA	HASZNÁLATA APPLICATION
	BETON BETON	VASTAG DUR	MÁZOLT FINISARE	FAL VAKOLAT GAURILIN ZIDARIE	FINOM BELSŐ FINISARI INTERIOR	FINOM TŰZTŰZ FINISARI ZIDARIE			
FEKETE FILC (BARNA, SZÜRKE) PASLA NEAGRA ( MARO,GRI)				XXXX		XX			finom vakolat simítása, nagyobb vakolat szemcsékre Nivelarea stratului de finisare; pentru uz la finisaje cu granulat mare
FEHÉR FILC PASLA ALBA				XXXX	XXXX	XXXX			finom vakolat simítása, kisebb vakolat szemcsékre Nivelarea stratului de finisare; pentru uz la finisaje cu granulat mare
FINOM HABSZIVACS SPUMA FINA				XXXX	XXXX	XXXX			szabad homok eltávolítására, finom vakolatra, csempe lemosása fugázás után Eliminarea surplusului de nisip din stucaturile fine; curatarea placilor dupa imbinare
DURVA HABSZIVACS SPUMA DURA				XXXX	XXXX	XXXX			szabad homok eltávolítására, durva vakolatra Eliminarea surplusului de nisip; pentru stucaturi grosiere
RASZTERES HABSZIVACS SPUMA MOLITAN				XXXX	XXXX	XXXX			szabad homok eltávolítására, raszter segítségével jobban felfogja a durva szemcséket, csempe lemosása fugázás után Eliminarea surplusului de nisip, multumita buretelui molitan curatarea sucaturilor dur este mai buna
TENGERI SZIVACS BURETE DE MARE					XXX		XXXX		fuga anyag lemosása Spalarea materialului de lipire
HYDRO SZIVACS DURVA, FINOM BURETE HYDRO FIN/DUR					X		XXXX		fuga anyag lemosása Spalarea materialului de lipire
SZIVACS BURETE				XX	XXXX	XX	XXXX		fuga anyag lemosása, finom vakolat végső tisztítása, vakolat lesimítása Spalarea materialului de lipire, asigurarea tencuielilor fine; gletuire.
MIKROGUMI CAUCIUC							XXXX		fuga anyag benyomása a fugába Aduna materialul de lipire in zona lipirii
GUMI SZIVACS SPUMA CAUCIUCATA							XXXX		fuga anyag benyomása a fugába Aduna materialul de lipire in zona lipirii
MIRELON BURETE TIP MIRELON		XXXX	XXX						beton megmunkálása, durva stukk vakolat megmunkálása Folosita la aplicarea cimentului acopera gaurile din zidarie
DUREN BURETE TIP DUREN				XXXX	XX	XXXX			finom vakolat egyenesítése, általában a vakolatok befejezésére Potrivita pentru tencuieli fine; finisare.
FA LEMN	XXXX	XXXX	XXXX						beton megmunkálása, durva stukk vakolat megmunkálása Folosita la aplicarea cimentului acopera gaurile din zidarie
ACÉL LAP PLACA DE OTEL	XX	XXXX		XX		XX	XX		beton glettelés, elkenése, nehezen elérhető helyek Netezirea cimentului in locuri inaccesibile.
POLISZTIROL POLISTIREN	XXX	XXXX	XXXX	XX		XX			beton megmunkálása, durva stukk vakolat megmunkálása Folosita la aplicarea cimentului acopera gaurile din zidarie
POLYURETAN POLIURETAN	XXXX	XXXX	XXXX						beton megmunkálása, durva vakolat megmunkálása Folosita la aplicarea cimentului acopera gaurile din zidarie
ABS		XX		XXXX	XXXX	XXXX		XXXX	ragasztó, vakolat, stukk vakolat felrakása Uniformizarea pe suprafata a adezivilor,tencuielilor.etc
SIMA ROZSDAMENTES OTEL NETED				XXXX	XXXX	XXXX		XXXX	ragasztó, vakolat, stukk vakolat felrakása Uniformizarea pe suprafata a adezivilor,tencuielilor.etc
FOGAS ROZSDAMENTES OTEL INOXIDABIL CU DINTI							XXXX		ragasztó felkenése csempére, padlócsempére Uniformizarea adezivilor pentru fatade sau pavari.
CSISZOLÓ SIMÍTÓ POLISZTIROLRA, MŰANYAG RAZUITOR			XX					XXXX	polisztirol csiszolása, cement ragasztók csiszolása Razuirea polistirenului si a adezivilor de ciment.
CSISZOLÓ SIMÍTÓ POLISZTIROLRA, FALAP RAZUITOR			XX					XXXX	polisztirol csiszolása, cement ragasztók csiszolása Razuirea polistirenului si a adezivilor de ciment.

FEHÉR FILCES SIMITÓ  
GLETIERA CU CAUCIUC

FESTA®



34400	280 x 140 x 10 mm	8
34415	250 x 130 x 10 mm	8
34450	220 x 130 x 10 mm	8
34445	220 x 70 x 10 mm	1

PÓT FILC  
REZERVA



34241	280 x 140 x 10 mm	1
34223	250 x 130 x 10 mm	1
34460	220 x 130 x 10 mm	1
34475	220 x 70 x 10 mm	1

MŰANYAG SIMITÓ FEKETE FILCES  
GLETIERA CU PASLA

FESTA®



34401	280 x 140 x 10 mm	8
34416	250 x 130 x 10 mm	8
34451	220 x 130 x 10 mm	40
34446	220 x 70 x 10 mm	1

PÓT FILC  
REZERVA PASLA



34243	280 x 140 x 10 mm	1
34221	250 x 130 x 10 mm	1
34461	220 x 130 x 10 mm	1
34476	220 x 70 x 10 mm	1

KEMÉNY SZIVACSOS SIMITÓ  
GLETIERA CU BURETE MOLITAN

FESTA®

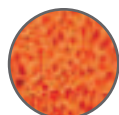

34441	280 x 130 x 12 mm	8
34440	250 x 130 x 12 mm	8

PÓT SZIVACS  
REZERVA

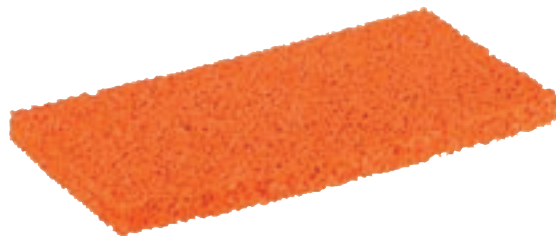

34473	280 x 130 x 12 mm	1
34472	250 x 130 x 12 mm	1

SZIVACSOS SIMITÓ  
GLETIERA CU BURETE

FESTA®



34405	280 x 140 x 18 mm	NEW 34480	280 x 140 x 12 mm	1
34420	250 x 130 x 18 mm	NEW 34481	250 x 130 x 12 mm	1
34454	220 x 130 x 18 mm	NEW 34482	220 x 130 x 12 mm	1
34449	220 x 70 x 18 mm			1

SZIVACSOS SIMITÓ  
REZERVA



34262	280 x 140 x 18 mm	NEW 34490	280 x 140 x 12 mm	1
34227	250 x 130 x 18 mm	NEW 34491	250 x 130 x 12 mm	1
34465	220 x 130 x 18 mm	NEW 34492	220 x 130 x 12 mm	1
34474	220 x 70 x 18 mm			1

KEMÉNY SZIVACSOS SIMITÓ  
GLETIERA CU BURETE MOLITAN

FESTA®

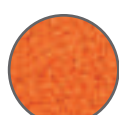

34442	250 x 130 x 12 mm	8
34443	280 x 130 x 12 mm	8

PÓT SZIVACS  
REZERVA



34471	280 x 130 x 12 mm	1
34470	250 x 130 x 12 mm	1



SZIVACSOS SIMÍTÓ  
GLETIERA CU BURETE MOLITAN

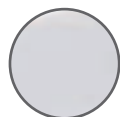

<b>34404</b>	280 x 140 x 30 mm	<b>34419</b>	250 x 130 x 20 mm	8
<b>NEW 34485</b>	280 x 130 x 20 mm	<b>34453</b>	220 x 130 x 20 mm	8
<b>NEW 34486</b>	250 x 130 x 30 mm	<b>34447</b>	220 x 70 x 10 mm	8

SZIVACSOS SIMÍTÓ HASÍTOTT  
GLETIERA CU BURETE MOLITAN



<b>34409</b>	280 x 140 x 30 mm	8
<b>34425</b>	250 x 130 x 20 mm	8

KEMÉNY SZIVACSOS SIMÍTÓ  
GLETIERA CU BURETE MOLITAN



<b>34410</b>	280 x 140 x 30 mm	8
<b>34426</b>	250 x 130 x 20 mm	8

TENGERI SZIVACSOS SIMÍTÓ  
GLETIERA CU BURETE



<b>34406</b>	280 x 140 x 40 mm	8
<b>34421</b>	250 x 130 x 30 mm	8
<b>34455</b>	220 x 130 x 30 mm	40

TENGERI SZIVACSOS SIMÍTÓ HASÍTOTT  
GLETIERA CU BURETE



<b>34413</b>	280 x 140 x 40 mm	8
<b>34428</b>	250 x 130 x 30 mm	8

PÓT SZIVACS  
REZERVA



<b>34251</b>	280 x 140 x 30 mm	1	<b>34224</b>	250 x 130 x 20 mm	1
<b>NEW 34295</b>	280 x 130 x 20 mm	1	<b>34464</b>	220 x 130 x 20 mm	1
<b>NEW 34296</b>	250 x 130 x 30 mm	1	<b>34477</b>	220 x 70 x 20 mm	1

PÓT SZIVACS ROVÁTKÁLT  
REZERVA



<b>34253</b>	280 x 140 x 30 mm	1
<b>34225</b>	250 x 130 x 20 mm	1

PÓT SZIVACS  
REZERVA



<b>34261</b>	280 x 140 x 30 mm	1
<b>34226</b>	250 x 130 x 20 mm	1

PÓT TENGERI SZIVACS  
REZERVA



<b>34265</b>	280 x 140 x 40 mm	1
<b>34228</b>	250 x 130 x 30 mm	1
<b>34466</b>	220 x 130 x 30 mm	1

PÓT TENGERI SZIVACS HASÍTOTT  
REZERVA



<b>34264</b>	280 x 140 x 40 mm	1
<b>34233</b>	250 x 130 x 30 mm	1

SZIVACOS SIMÍTÓ  
GLETIERA CU BURETE

FESTA®

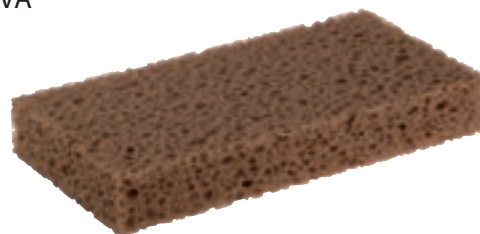

<b>34412</b>	280 x 140 x 40 mm	8
<b>34424</b>	250 x 130 x 30 mm	8
<b>34458</b>	220 x 130 x 30 mm	10

PÓTSZIVACS  
REZERVA

<b>34238</b>	280 x 140 x 40 mm	1
<b>34236</b>	250 x 130 x 30 mm	1
<b>34469</b>	220 x 130 x 30 mm	1

SZIVACOS SIMÍTÓ  
GLETIERA CU BURETE

FESTA®



NEW



<b>34490</b>	280 x 140 x 30 mm	8
<b>34491</b>	250 x 130 x 30 mm	8

PÓTSZIVACS  
REZERVA

NEW

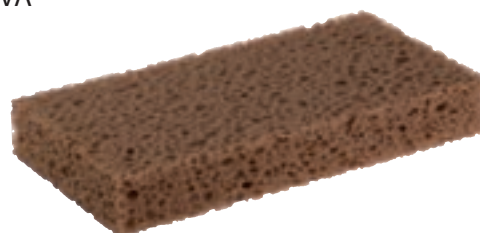

<b>34298</b>	280 x 140 x 30 mm	1
<b>34299</b>	250 x 130 x 30 mm	1

SZIVACOS SIMÍTÓ  
GLETIERA CU BURETE

FESTA®



<b>34411</b>	280 x 140 x 40 mm	10
<b>34423</b>	250 x 130 x 30 mm	10
<b>34457</b>	220 x 130 x 30 mm	10

PÓTSZIVACS  
REZERVA

<b>34237</b>	280 x 140 x 40 mm	1
<b>34235</b>	250 x 130 x 30 mm	1
<b>34468</b>	220 x 130 x 30 mm	1

GUMIS SIMÍTÓ  
GLETIERA CU CAUCIUC

FESTA®



<b>34402</b>	280 x 140 x 10 mm	8
<b>34417</b>	250 x 130 x 10 mm	8
<b>34452</b>	220 x 130 x 10 mm	40

PÓT GUMI  
REZERVA

<b>34231</b>	280 x 140 x 10 mm	1
<b>34222</b>	250 x 130 x 10 mm	1
<b>34462</b>	220 x 130 x 10 mm	1

MŰANYAG SIMÍTÓ MIKROGUMIVAL  
GLETIERA CU CAUCIUC

FESTA®



<b>34403</b>	280 x 140 x 8 mm	8
<b>34418</b>	250 x 130 x 8 mm	8

PÓT SZIVACS  
REZERVA MICRORUBBER

<b>34232</b>	280 x 140 x 8 mm	1
<b>34230</b>	250 x 130 x 8 mm	1
<b>34463</b>	220 x 130 x 8 mm	1

SZIVACSOS SIMÍTÓ  
GLETIERA CU BURETE

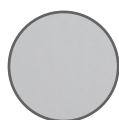

**34408** 280 x 140 x 20 mm  
**34427** 250 x 130 x 20 mm

8  
8

SZIVACSOS SIMÍTÓ  
REZERVA



**34268** 280 x 140 x 20 mm  
**34229** 250 x 130 x 20 mm

1  
1

SZIVACSOS SIMÍTÓ DUREN  
GLETIERA CU DUREN



**34407** 280 x 140 x 20 mm  
**34422** 250 x 130 x 20 mm  
**34456** 220 x 130 x 20 mm  
**34448** 220 x 70 x 20 mm

8  
8  
8  
1

PÓT SZIVACS  
REZERVA



**34266** 280 x 140 x 20 mm  
**34267** 250 x 130 x 20 mm  
**34467** 220 x 130 x 20 mm  
**34478** 220 x 70 x 20 mm

1  
1  
1  
1

SZIVACSOS SIMÍTÓ DUREN  
GLETIERA CU DUREN



**34448** 220 x 70 x 10 mm

10

FEHÉR FILCES SIMÍTÓ  
GLETIERA CU CAUCIUC



**34445** 220 x 70 x 10 mm

40

SIMITÓ  
GLETIERA



**30003** 270 x 125 mm  
**30004** 235 x 115 mm  
**30005** 205 x 115 mm  
**30007** 205 x 60 mm

40  
40  
40  
40

SZIVACSOS SIMÍTÓ 90°  
GLETIERA CU BURETE 90°



**34500**

6

**ELEKTROMOS HABARCS ÉS FESTÉKKEVERŐ 850W**  
**AMESTECĂTOR MATERIALE DE CONSTRUCȚIE, 850 W**

35300

NEW 35316 Náhradní uhlík/ Spare carbon

Teljesítmény/ Putere:	850W
Hálózati feszültség/ Tensiune:	230V/50Hz
Fokozatok száma/ Number of gears:	1
1. Üresjárat fordulatszám/ nivel (turații libere):	0-500 ot./min.
2. Üresjárat fordulatszám/ nivel (turații libere):	-
Védelem/ Protecție la suprasolicitare:	igen/ Yes
Závit míchací metly/ Filet tel de mestecare:	M14
Keverőlapát/ Diametrul coșului de amestecat:	120mm
Keverőlapát hossza/ Lungimea telului de amestecat:	600mm
Tömeg/ Weight:	3,7kg



Zn

1  
1
**ELEKTROMOS HABARCS ÉS FESTÉKKEVERŐ 1600W**  
**AMESTECĂTOR MATERIALE DE CONSTRUCȚIE, 1600 W**

35310

NEW 35317 Náhradní uhlík/ Spare carbon

Teljesítmény/ Putere:	1600W
Hálózati feszültség/ Tensiune:	230V/50Hz
Fokozatok száma/ Number of gears:	2
1. Üresjárat fordulatszám/ nivel (turații libere):	0-480 ot./min.
2. Üresjárat fordulatszám/ nivel (turații libere):	0-800 ot./min.
Védelem/ Protecție la suprasolicitare:	igen/ Yes
Závit míchací metly/ Filet tel de mestecare:	M14
Keverőlapát/ Diametrul coșului de amestecat:	140mm
Keverőlapát hossza/ Lungimea telului de amestecat:	600mm
Tömeg/ Weight:	4,7kg



Zn

1  
1
**HABARCS KEVERŐSZÁR**  
**PALETA**

Zn



35059	M14	∅ 90 mm	2 lame	24
35085	M14	∅ 120 x 600mm		12
35086	M14	∅ 140 x 600mm		12
35087	M14	∅ 160 x 600mm		12

bal kezés, órájással ellentétes- nagy terjedelmű cementhabarcs keverésére.

Paleta spirala cu 3 lame si prindere cu filet M14 -sens de rotire orar. Datorita faptului ca in timpul rotirii paleta impinge in jos materialul, se evita stropirea si totodata se obtine o pigmentatie uniforma a vopselelor.

**HABARCS KEVERŐSZÁR**  
**PALETA**

Zn



35091	M14	∅ 120 x 600mm		12
35092	M14	∅ 140 x 600mm		12
35093	M14	∅ 160 x 600mm		12

Spiral mixer: -jobb kezés- nehezen keverhető anyagokhoz. Vakolóanyagok, méasztartalmú vakolatok, beton és bitumenes kötőanyagok keverésére

Paleta spirala cu 3 lame cu prindere cu filet M14 -sens antiorar. Pentru materiale cu grad mare de vascozitate : ciment, mortar, beton, materiale de imbinare , mortare epoxidice, rasini, materiale bituminoase. In timpul rotirii paleta creaza un efect de ridicare a materialului care genereaza o fixare si circulare a paletii in masa mixturii asemeni unui surub.

**KEVERŐSZÁR KÖRREL HORGANYZOTT**  
**PALETA SPIRALA MIXER**

Zn



35038	∅ 80 x 500mm	24
35058	∅ 100 x 500mm	24
35023	∅ 120 x 500mm	24

Habarcsok, készvakolatok, csemperagasztók, glett anyagok keverésére.

Paleta spirala cu 2 lame pentru amestecarea cimentului si materialelor de imbinare, sapelor, mortarelor usoare, si materialelor de finisare.

### HABARCS KEVERŐSZÁR PALETA



Zn

SDS+



<b>35094</b>	∅ 80 x 500mm	24
<b>35095</b>	∅ 100 x 500mm	24
<b>35096</b>	∅ 120 x 500mm	24

Habarcok, készvakolatok, csempereasztók, glett anyagok keverésére.

Paleta spirala cu 2 lame si prindere SDS+ pentru amestecarea cimentului, materialelor de imbinare si finisare.

### KEVERŐSZÁR HORGANYZOTT PALETA SPIRALA

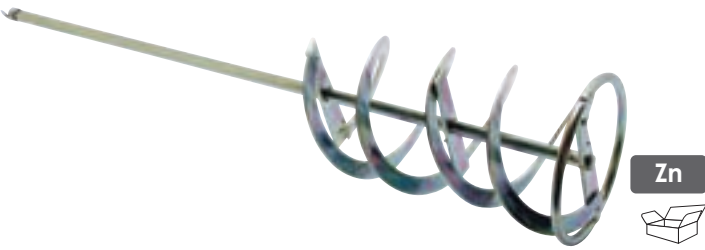

Zn



<b>35013</b>	∅ 80 x 500mm	24
<b>35006</b>	∅ 100 x 500mm	24
<b>35007</b>	∅ 120 x 500mm	24

Habarcok, készvakolatok, csempereasztók, glett anyagok keverésére.

Paleta spirala cu 2 lame pentru amestecarea cimentului si materialelor de imbinare, sapelor, mortarelor usoare, si materialelor de finisare.

### HABARCS KEVERŐSZÁR PALETA SPIRALA CU FILET



Zn



<b>35069</b>	∅ 60 x 500mm	50
<b>35078</b>	∅ 80 x 500 mm	24
<b>35081</b>	∅ 100 x 500 mm	24

Habarcok, készvakolatok, csempereasztók, glett anyagok keverésére.

Paleta spirala cu 2 lame pentru amestecarea cimentului si materialelor de imbinare, sapelor, mortarelor usoare, si materialelor de finisare.

### HABARCS KEVERŐSZÁR PALETA SPIRALA CU FILET



Zn

SDS+



<b>35070</b>	∅ 60mm	50
<b>35079</b>	∅ 80mm	24
<b>35082</b>	∅ 100mm	24

Habarcok, készvakolatok, csempereasztók, glett anyagok keverésére.

Paleta spirala cu 2 lame pentru amestecarea cimentului si materialelor de imbinare, sapelor, mortarelor usoare, si materialelor de finisare.

### KEVERŐSZÁR KÖR NÉLKÜL HORGANYZOTT PALETA SPIRALA MIXER



Zn



<b>35048</b>	∅ 70 x 500mm	24
<b>35068</b>	∅ 90 x 500mm	24

Habarcok, készvakolatok, csempereasztók, glett anyagok keverésére.

Paleta spirala cu 2 lame pentru amestecarea cimentului si materialelor de imbinare, sapelor, mortarelor usoare, si materialelor de finisare.

**KEVERŐSZÁR HORGANYZOTT  
PALETA SPIRALA**

**35021** Ø 100 x 500mm

Zn



24

Habarcok, készvakolatok, csempereasztók, glett anyagok keverésére.

Paleta mixer elicoidala pentru amestecarea materialelor cu grad mare de vascozitate cum ar fi adezivii pentru constructii, mortar sau sape.

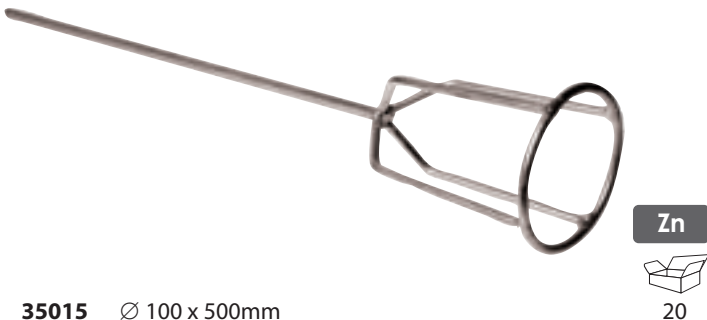
**KEVERŐSZÁR, KALITKÁS, HORGANYZOTT  
PALETA MIXER**

**35015** Ø 100 x 500mm

Zn



20

glettanyagok, tömítőanyagok, ragasztók, habarcok keverésére

Paleta mixer tip cusca pentru amestecul materialelor unde nu este permisă intrarea aerului în mixtura. Pentru materiale fluide, folosite la finisari, etansari sau adezivi.

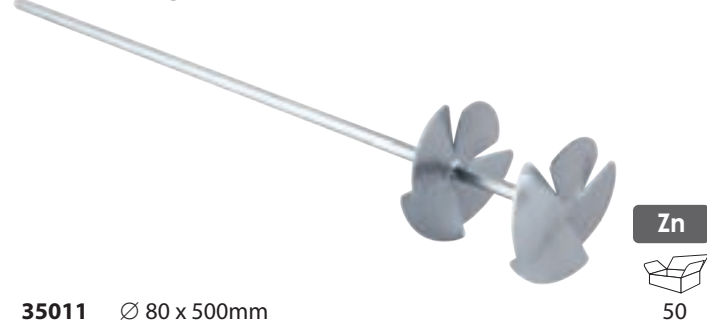
**KEVERŐSZÁR KÉT PROPELLERREL HORGANYZOTT  
PALETA ELICE**

**35011** Ø 80 x 500mm

Zn



50

folyékony anyagok, festékek, tapéta és csempereasztók keverésére.

Paleta mixer tip elice pentru amestecarea materialelor fluide; vopsele adezivi pentru tapet sau adezivi pentru placi cu grad mic de vascozitate

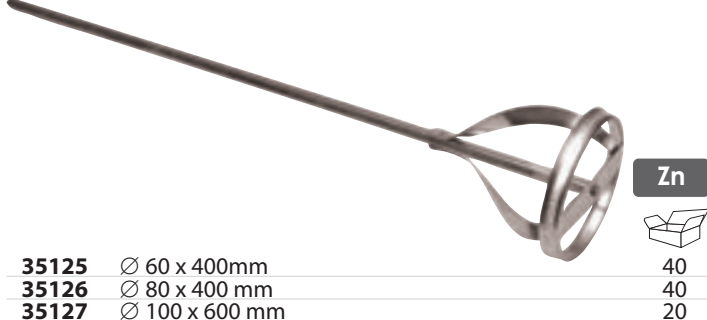
**KEVERŐSZÁR  
PALETA**

**35125** Ø 60 x 400mm

**35126** Ø 80 x 400 mm

**35127** Ø 100 x 600 mm

Zn



40

40

20

Mindenfajta falfesték és diszperziós festék, ragasztók, beton, esztrich, cement keverésére.

Paleta zincata tip arcada pentru amestecul vopselelor lavabile sau de dispersie; adezivilor, materialelor bituminoase..etc..

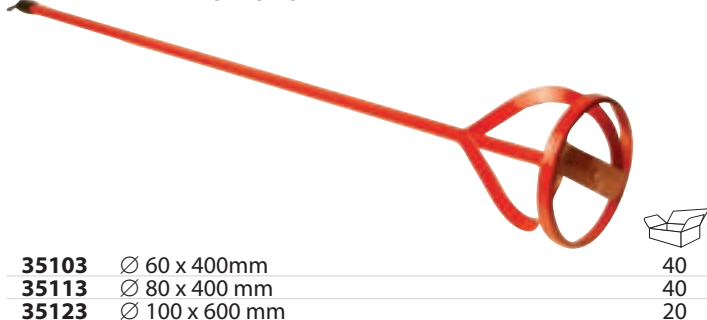
**KEVERŐSZÁR - FESTETT  
PALETA PENTRU VOPSELE**

**35103** Ø 60 x 400mm

**35113** Ø 80 x 400 mm

**35123** Ø 100 x 600 mm

40

40

20

Mindenfajta falfesték és diszperziós festék, ragasztók, beton, esztrich, cement keverésére.

Paleta tip arcada cu inel pentru amestecul vopselelor lavabile, adezivilor, sapelor, sau bitumului.

# Lescha

PROFI BETONKEVERŐK  
PROFESSIONAL BUILDING MIXERS

Profi igényeket kielégítő betonkeverők  
Öntöttvas hajtó fogaskoszorú .... rögzítéssel  
Pórszórt felületek  
DIN EN ISO 900 nak megfelelő minőség biztosítás  
Speciális formájú keverődob  
IP 45 splash biztos védelem  
220V és 380V-s meghajtás

Betoniera profesionala  
Betoniera pentru uz profesional  
Roata dintata din material de fonta cu dinti reglabili  
Cuva atasata de sasiu cu dublu rulmenti  
Izolație de protecție patentat, protecție de calitate conform DIN EN ISO 900  
Finisaj de calitate superioara  
Cuva conceputa cu un design special  
Alimentare 220V și 380V

## BETONKEVERŐ BETONIERA



**35500** Star 150 125L/220V



## BETONKEVERŐ BETONIERA



**35502** Euro-Mix 125L/220V  
**35503** Euro-Mix 125L/380V



## BETONKEVERŐ BETONIERA



**35501** BX 135 125L/220V



## BETONKEVERŐ BETONIERA



**35504** ABM 135/220V



## BETONKEVERŐ BETONIERA



**35505** SM 145 S 140L/220V  
**35506** SM 145 S 140L/380V  
**35507** SM 145 S 140L/220V NB  
**35508** SM 145 S 140L/380V NB



## BETONKEVERŐ BETONIERA



**35510** SM 165 S 160L/220V  
**35511** SM 165 S 160L/380V  
**35512** SM 165 G benzines

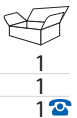

## BETONKEVERŐ BETONIERA



**35514** SM 185 S 180L/220V  
**35515** SM 185 S 180L/380V



## BETONKEVERŐ BETONIERA



**35516** S 180 HR 180L/220V  
**35517** S 180 HR 180L/380V



BETONKEVERŐ  
BETONIERA



**Lescha**



35520	LB200T/220V, 0.55kW	1
35522	LB200T/Honda G150QE	1
35523	LB200T/Robin EY15DU	1
35524	LB354/220V, 1.5kW	1
35525	LB354/380V, 1.5kW	1
35526	LB354/Briggs 3.5kW	1
35527	LB354/Honda G200	1
35528	LB354/Honda GX120LX	1
35529	LB354/Robin EH12B	1
35530	LB354/Robin EY20DU	1
35532	LB404/220V, 1.5kW	1
35533	LB404/380V, 1.5kW	1
35534	LB404/Briggs 3.5kW	1
35535	LB404/Honda G200	1
35536	LB404/Honda GX120LX	1
35537	LB404/Robin EH12B	1
35538	LB404/Robin diesel	1
35542	LB484/380V, 2kW	1
35539	LB484/Robin EH17B	1
35540	LB484/Honda GX160LX	1
35541	LB484/Robin Diesel	1

HIDRAULIKUS BETONKEVERŐ  
BETONIERA HIDRAULICA



**Lescha**



35543	LHB360/380V	1
35544	LHB360/HATZ Diesel	1
35545	LHB360, nahrn. lopata	1
35546	LHB550/380V	1
35547	LHB 550/Hatz Diesel	1
35548	LHB550, nahrn. lopata	1
35549	LHB800/380V	1
35550	LHB800/HATZ Diesel	1
35551	LHB800, nahrn. lopata	1
35552	LHB1000/380V	1
35553	LHB1000/HATZ Diesel	1
35554	LHB1000, Nahr.lopata	1
35555	LHB1200/380V	1
35556	LHB1200/HATZ Diesel	1

BETONKEVERŐ  
BETONIERA



**Lescha**



35518	S 230 HR 230L/220V	1
35519	S 230 HR 230L/380V	1

BETONKEVERŐ ROSTAKOSÁR  
CUVA CU SITA

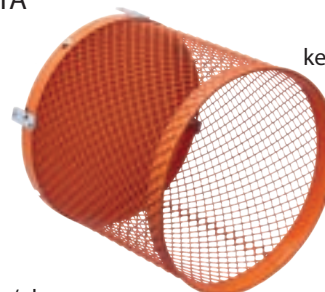

**Lescha**



keverőkhöz /for mixers:  
35500, 35501,  
35502, 35503,  
35504, 35505,  
35506, 35507,  
35508, 35510,  
35511, 35512



35560	durva / dura	1
35561	finom / fina	1

BETONKEVERŐ  
BETONIERA



37500	MK 130	szétszerelt/ unassembled	1
37501	MK 130	összeszerelt/ assembled	1
37505	MK 130	szétszerelt/ unassembled	1
37506	MK 130	összeszerelt/ assembled	1

BETONKEVERŐ  
BETONIERA



35557	SM-150/220V	1
35531	SM-150/400V	1

BETONKEVERŐ  
BETONIERA

**NEW**



37515	162L / 230V	rozložená/ unassembled	1
37516	162L / 230V	složená/ assembled	1

BETONKEVERŐ  
BETONIERA



37509	SM-126/230V -	összeszerelt/ assembled	1
37510	SM-126/230V -	szétszerelt/ unassembled	1



CSÚSZDA ÉPÍTÉSI TÖRMELEKNEK  
JGHEAB PENTRU MOLOZ

**Lescha**



<b>35600</b>	Csúszda építési törmeléknek 50/40cm x 110cm/ Jgheab pentru moloz din plastic diagonala 50/40cm, lungime 110cm	1
<b>35601</b>	Betöltő tölcser Cap jgheab plastic pentru umplere resturi de constructii	1
<b>35602</b>	Mellvédkeret Suport aluminiu pentru jgheab moloz	1



TALICSKA PVC  
ROABĂ



**37520** 180 l /38



TALICSKA  
ROABĂ CONSTRUCȚII ZINCATĂ



**37541** 80 l



HÁROM KERÉKŰ TALICSKA  
WHEELBARROW HULL BLACK



**37564** 60 l



TALICSKA  
ROABĂ CONSTRUCȚII



<b>37530</b>	60 l /38	tömör gumi/solid tyre	1
<b>37532</b>	60 l /40	gumiabroncsa/ pneumatic tyre	1



TALICSKA, HORGANYZOTT  
ROABĂ CONSTRUCȚII ZINCATĂ



<b>37527</b>	80 l /40	gumiabronccsal/ roată gonflabilă	1
<b>37533</b>	80 l /38	roată autoportantă	1



TALICSKA  
ROABĂ CONSTRUCȚII



**37539** 60 l



PÓTKERÉK  
ROATĂ



<b>48729</b>	typ AA 400	gumiabronccsal/ roată gonflabilă	1
<b>48730</b>	typ AA 380	roată autoportantă	1
<b>48731</b>	typ AA 380	roată autoportantă Slovakia	1



MOLNÁRKOCSI  
HAND TRUCK



**48719** 14/ 250 kg kerék 260 bantam



BURKOLAT TÖRŐ  
APARAT DE TAIAT PAVAJ



60119 PRO 011, 50cm



BURKOLAT TÖRŐ  
APARAT DE TAIAT PAVAJ



60120 PRO 013, 42cm



SZEGÉLY HORDOZÓ  
DISPOZITIV DE RIDICAT BOLTARE



60115 PRO 040



SZEGÉLY HORDOZÓ  
DISPOZITIV DE RIDICAT BOLTARE



60116 PRO 041



SZEGÉLY HORDOZÓ  
DISPOZITIV DE RIDICAT BOLTARE



60117 PRO 042  
60118 PRO 043



SOR EGYENGETŐ PÁLCA  
BAROS PIETRAR



60121 PRO 030



BURKOLAT ALÁTÉTT  
SUPORT REGLABIL



37166 D10 basic



BURKOLAT ALÁTÉTT  
SAIBA PAVAJ



37167 V3 Ki egyenesítő / leveling  
37168 V5 Ki egyenesítő / leveling



20

ÁLLÍTHATÓ BAK  
CAPRA AJUSTABILA



36300 79 - 130 cm, max. 150 kg



ÁLLÍTHATÓ BAK  
CAPRA AJUSTABILA



37545 140cm  
37546 120cm



1

# SUPER PRO

PROFI CSEMPEVÁGÓ  
MASINI DE TAIAT PLACI

Legigényesebb profi csempevágó.  
A mozgató 9 STK golyóscsapággal történik  
A mozgástér behatárolása végett ebből négy állítható.  
Alárugózott (lökés csillapított) asztal.  
Pót alkatrészek és szervíz biztosított.  
Krom-wolfrám acélos vágókerekek.

Masini de taiat placi pentru cele mai uzuale utilizari  
glisarea este asigurata de 9 rulmenti SFK  
4 dintre ei sunt reglabili si definesc limitele cursei platou ajustabil  
Posibilitatea de asamblare, pentru mana stanga  
Toate accesoriile si service-ul sunt garantate  
Discuri taietoare, din aliaj crom-wolfram

## CSEMPEVÁGÓ SUPER PRO 4 MASINA DE TAIAT PLACI SUPER PRO

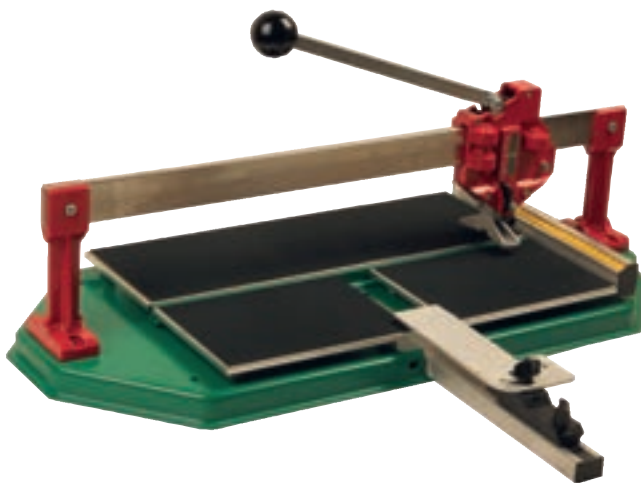

36145	SUPER PRO 450	1
36160	SUPER PRO 600	1
36175	SUPER PRO 750	1
36190	SUPER PRO 900	1
36195	Tartalék vágókerek / Disc de rezerva Ø 22 mm	6

## CSEMPEVÁGÓ BASIC PLUS MASINA DE TAIAT PLACI BASIC PLUS



36230	300 mm	1
36240	400 mm	1
36250	500 mm	1
36260	600 mm	1
36261	Tartalék vágókerek / Disc de rezerva Ø 15 mm	1

## BEMUTATÓ ÁLLVÁNY SUPER PRO STAND PENTRU SUPER PRO

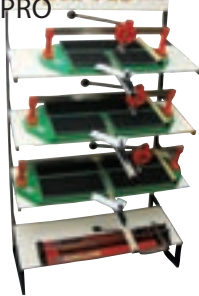

36200

1

## CSEMPEVÁGÓ KÖRKIVÁGÓVAL MASINA DE TAIAT

FESTA®



36080	600 mm	1
36081	750 mm	1
36082	900 mm	1

## CSEMPEVÁGÓ KÖRKIVÁGÓVAL MASINA DE TAIAT

FESTA®



36085	600 mm	1
NEW 36087	900 mm	1
NEW 36086	1300 mm	1
NEW 36138	Tartalék vágókerek / Disc de rezerva	1

## CSEMPEVÁGÓ KÖRKIVÁGÓVAL MASINA DE TAIAT

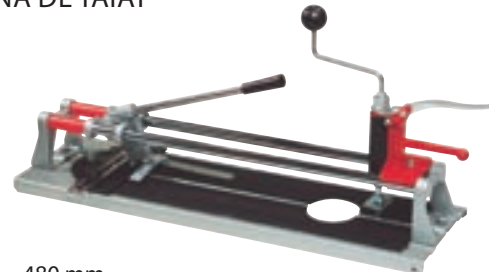

HOBBY

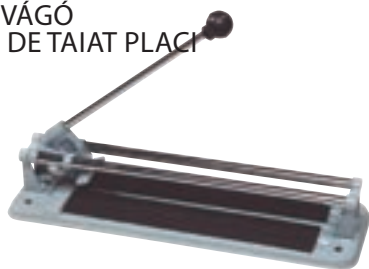

36014	480 mm	4
36128	Tartalék vágókerek Ø16 mm/3 mm / Disc de rezerva	1

CSEMPEVÁGÓ  
MASINA DE TAIAT PLACI

<b>36024</b>	300 mm	10
<b>36034</b>	400 mm	10
<b>36035</b>	600 mm	4
<b>36126</b>	Tartalék vágókerék / Disc de rezerva $\varnothing$ 15 mm	1

CSEMPEVÁGÓ  
MASINA DE TAIAT PLACI

<b>36036</b>	500 mm	4
<b>36136</b>	Tartalék vágókerék $\varnothing$ 22 mm / Disc de rezerva	1

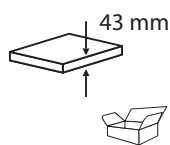
ELEKTROMOS CSEMPEVÁGÓ  
MASINA ELECTRICA PENTRU TAIAT PLACI230V 50Hz  
600W

<b>36090</b>		1
<b>21218</b>	Tartalék vágókerék / Disc de rezerva	10

SZÚRÓFŰRÉSZ LAP KERÁMIÁHOZ, BOSCH  
LAME DE FERASTRU

<b>24055</b>	karbid/carbura BOSCH	20
--------------	----------------------	----

KÉZI CSEMPEVÁGÓ  
DISPOZITIV MANUAL DE TAIAT PLACI

<b>36046</b>	22 mm	36
<b>36136</b>	Tartalék vágókerék / Disc de rezerva $\varnothing$ 22 mm	1

CSEMPE (VÁGÓ-LETÖRŐ) FOGÓ  
CLESTI PENTRU TAIAT PLACI

<b>36056</b>		50
--------------	--	----

TARTALÉK VÁGÓKERÉK  
DISC DE REZERVA

<b>36126</b>	a= $\varnothing$ 15 mm, b= $\varnothing$ 6 mm, c= 1,5 mm	1
<b>36128</b>	a= $\varnothing$ 16 mm, b= $\varnothing$ 6 mm, c= 3 mm	1
<b>36130</b>	a= $\varnothing$ 20 mm, b= $\varnothing$ 6 mm, c= 5 mm	1
<b>36136</b>	a= $\varnothing$ 22 mm, b= $\varnothing$ 6 mm, c= 2 mm	1

CSEMPECSÍPÓ FOGÓ  
CLESTE PENTRU PLACI

<b>36058</b>	200mm	6
--------------	-------	---

FUGA TISZTÍTÓ  
RAZUITOR CU CARBURI

<b>37006</b>	30 mm	20
<b>37007</b>	50 mm	20
<b>37008</b>	Pót pengeél 30 mm/lama de rezerva	50
<b>37009</b>	Pót pengeél 50 mm/lama de rezerva	50

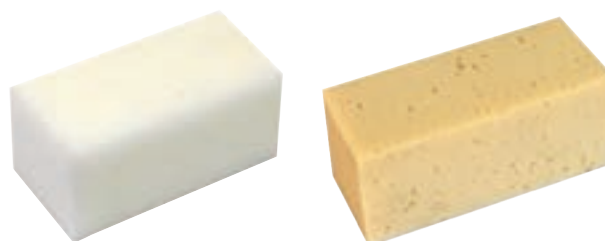
SZIVACSKOCKA 200x100x100 mm  
BURETE BLOC 200x100x100 mm

<b>37025</b>	finom szivacsokocka / Burete molitan bloc	40
<b>37026</b>	tengeri szivacsokocka / Burete bloc	40

PADLÓCSEMPE TARTÓ  
RIDICATOR CARAMIZI



**36310** 30-50cm



3

CSEMPELHÚZÓ GUMI FA NYÉLLEL  
SPACLU CAUCIUC

**FESTA**

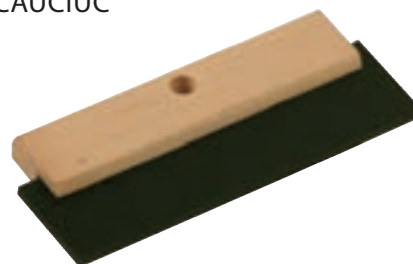

**37011** 180 mm  
**37021** 280 mm



12

12

MŰANYAG SPATULA  
SPACLU DIN PLASTIC



**37031** 4 x 6 mm  
**37041** 6 x 6 mm  
**37051** sima/sima



60

60

60

SZILIKON FUGAKIHÚZÓ  
SPATULA PENTRU SILICON

NEW



**37053** Sada 4 db/buc



1

SZILIKON FUGAKIHÚZÓ  
SPATULA PENTRU SILICON



**37054**



1

SZILIKON FUGAKIHÚZÓ  
SPATULA PENTRU SILICON



**37055** Ablak fúgasimitó / pentru imbinari de ferestre



1

MŰANYAG SPATULA  
SPATULA DINTATA-PLASTIC

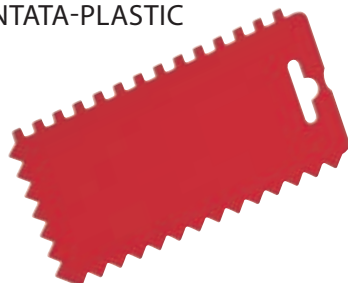

**37101** 150 x 80 mm  
**37111** 170 x 115 mm



100

100

MŰANYAG CSEMPEÉK  
PENE PLASTIC

**FESTA**



**37155** 0-8 mm 30 db/buc  
**37156** 0-4 mm 100 db/buc  
**37157** 2,5-8 mm 30 db/buc



100

100

100

MŰANYAG FUGAKERESZT  
DISTANTIÉRE PLASTIC

**FESTA**



100

100

100

100

100

100

100

100

100

100

100

100

ÜREGES MŰANYAG KERESZTEK  
DISTANTIÉRE PLASTIC IN CRUCE

**FESTA**



**37221** 4 mm 200 db/buc  
**37222** 5 mm 200 db/buc  
**37223** 6 mm 100 db/buc  
**37224** 7 mm 100 db/buc  
**37225** 8 mm 100 db/buc

20

20

100

20

20

BURKOLÓ VÖDÖR  
VAS PENTRU ZUGRAVI

37117	klt/set	1
90071	lehozó hengerek/role	25
90072	rács/grilaj	1
90070	vödör/vas 25l	6

FA ÉKEK  
PENE LEMN

37200	150x25x25-1mm, 8 db/buc	1
37201	100x25x16-1mm, 14 db/buc	1
37202	80x25x10-3mm, 20 db/buc	1
37203	65x18x12-0mm, 20 db/buc	1
37204	55x20x6-0mm, 20 db/buc	1
37205	55x8x10-0mm, 250 db/buc	1

PARKETTÁZÓ KLT.  
SET ASAMBLARE PARCHET LAMINAT

52130



1

FA ÉKEK  
PENE LEMN

37210 95 x 45 x 15-0 mm, 50 db/buc

37211 70 x 30 x 8-0 mm, 50 db/buc



1

1

TÁVTARTÓK 30 DB  
DISTANȚIERES 30 BUC

NEW



37170	1 mm	1
37171	2 mm	1
37172	3 mm	1

FA ÉKEK  
PENE LEMN

NEW

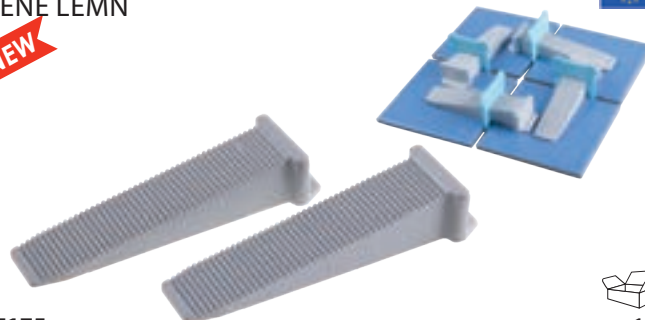

37175



1

NIVELAČNÍ KLEŠTĚ  
LEVELING GUNS

NEW



37177



1

KICSAPÓ ZSINOR KLT.  
PUDRA DE TRASAT37065 30 m - gyors csévézés / rulare rapida  
porfesték/pudra 120 g

12

FESTA®

PORFESTÉK  
PUDRA DE TRASAT

FESTA®

FESTA®

37096	180 g - kék/albastru	10
37094	180 g - fény kék/lumina albastru	10
37097	180 g - piros/rosu	10
37095	180 g - fény piros/lumina rosu	10
37098	180 g - fekete / negru	10



KICSAPÓZSINÓR - MŰANYAG  
FIR DE TRASAT DIN PLASTIC



37066 30 m



25

KICSAPÓZSINÓR - MŰANYAG ABS  
FIR DE TRASAT - CARCASA ABS, PLASTIC



37067 30 m



25

KICSAPÓZSINÓR  
FIR DE TRASAT - CARCASA METAL



37068 30 m



25

KICSAPÓZSINÓR KLT.  
FIR TRASAT



37069 30 m + porfesték 180 g/pudra



10

KŐMŰVES ZSINÓR 50 m  
SFOARA 50 m

**FESTA®**



38901 fehér/alb 1,0 mm  
38902 fehér/alb 1,7 mm  
38903 fehér/alb 2,0 mm



100  
100  
100

KŐMŰVES ZSINÓR 50 m  
SFOARA 50 m

**FESTA®**



38904 sárga/galben 1,0 mm  
38905 sárga/galben 1,7 mm  
38906 sárga/galben 2,0 mm



100  
100  
100

KŐMŰVES ZSINÓR 50 m  
SFOARA 50 m

**FESTA®**



38907 piros/rosu 1,0 mm  
38908 piros/rosu 1,7 mm  
38909 piros/rosu 2,0 mm



100  
100  
100

KŐMŰVES ZSINÓR 50 m  
SFOARA 50 m

**FESTA®**



38910 narancs/portocaliu 1,0 mm  
38911 narancs/portocaliu 1,7 mm  
38912 narancs/portocaliu 2,0 mm



100  
100  
100

KŐMŰVES ZSINÓR  
GREUTATE PENTRU FIR



38895 50 m piros/rosu  
38896 100 m piros/rosu  
38899 50 m sárga/galben  
38900 100 m sárga/galben



96  
96  
96  
96

FÖGGŐÓN 15m - ES ZSINÓRRAL  
FIR CU PLUMB 15 m

**FESTA®**

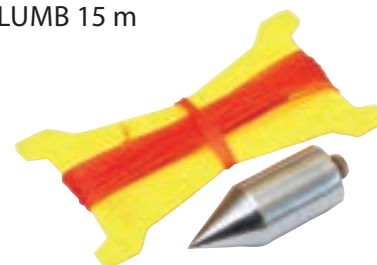

38916 150 g  
38917 300 g  
38918 500 g



5  
5  
5

FÖGGŐÓN  
PLUMB PENTRU FIR

FESTA®

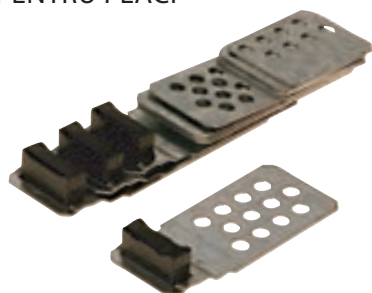

<b>38913</b>	150 g	5
<b>38914</b>	300 g	5
<b>38915</b>	500 g	5

CSEMPEMÁGNES  
MAGNETI PENTRU PLACI**38920** 4 db/buc

12

ALUMINIUM ÉLVÉDŐ  
COLTAR ALUMINIU

ALU

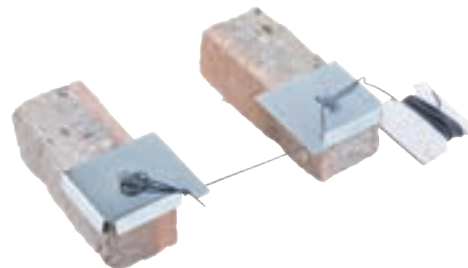

<b>39220</b>	2 m	100
<b>39225</b>	2,5 m	100
<b>39230</b>	3 m	100
<b>39221</b>	2 m dryvit háló/plasa fibra sticla	100
<b>39226</b>	2,5 m dryvit háló/plasa fibra sticla	100
<b>39231</b>	3 m dryvit háló/plasa fibra sticla	100

ÉPÍTÉSZETI SARKAK - KLT.  
COLTARE CU FIR DE NIVEL**38919**

50

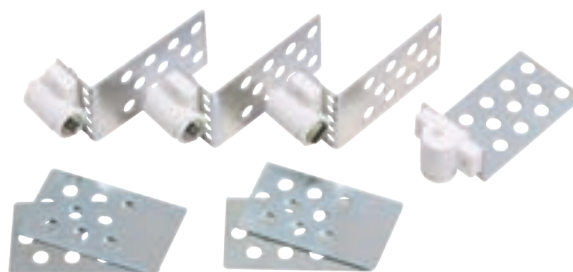
CSEMPEMÁGNES, ÁLLÍTHATÓ  
MAGNETI PENTRU PLACI**38923** 4 db/buc

80

ÉLVÉDŐ PVC.  
CORNIER PLASTIC

<b>39234</b>	2 m	100
<b>39236</b>	2,5 m	100
<b>39238</b>	3 m	100
<b>39235</b>	2 m dryvit háló/plasa fibra sticla	100
<b>39237</b>	2,5 m dryvit háló/plasa fibra sticla	100
<b>39239</b>	3 m dryvit háló/plasa fibra sticla	100

SZERELŐ ABLAK  
USI REVIZIE

nem szabványos  
méretek gyártására van  
lehetőség  
possibility of producing  
non-standard sizes



ALU

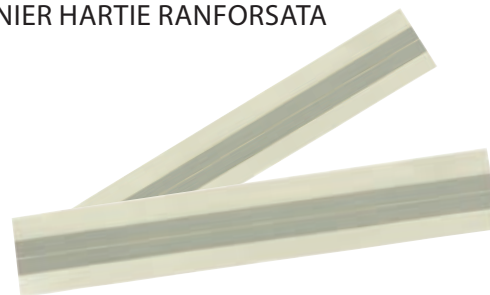

<b>82015</b>	15x15cm	1
<b>82020</b>	20x20 cm	1
<b>82030</b>	30x30 cm	1
<b>82040</b>	40x40 cm	1
<b>82050</b>	50x50 cm	1
<b>82060</b>	60x60 cm	1

PAPÍR ÉLVÉDŐ  
CORNIER HARTIE RANFORSATA**39245** AL 30 m x 5 cm

1

SZERELŐ ABLAK MÁGNESES  
USI REVIZIE MGNETIC

<b>82100</b>	25x25 cm SDK	1	<b>82105</b>	25x25 cm kőművesség/ zidarie	1
<b>82101</b>	35x35 cm SDK	1	<b>82106</b>	35x35 cm kőművesség/ zidarie	1
<b>82102</b>	45x45 cm SDK	1	<b>82107</b>	45x45 cm kőművesség/ zidarie	1
<b>82103</b>	55x55 cm SDK	1	<b>82108</b>	55x55 cm kőművesség/ zidarie	1
<b>82104</b>	63x63 cm SDK	1	<b>82109</b>	63x63 cm kőművesség/ zidarie	1

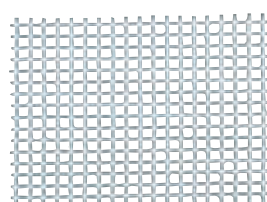
DRYVIT HÁLÓ  
PLASA FIBRA STICLA

<b>42110</b>	145 g/m <sup>2</sup>	4x5 mm	1 m x 50 m	4
<b>42112</b>	145 g/m <sup>2</sup>	4x5 mm	1 m x 10 m	10
<b>42113</b>	145 g/m <sup>2</sup>	4x5 mm	1 m x 20 m	8



DÜBEL  
DIBLU PLASTIC PENTRU POLISTIREN



39208	∅ 10 x 80 mm, 100db/buc	1
39210	∅ 10 x 100 mm, 100db/buc	1
39212	∅ 10 x 120 mm, 100db/buc	1
39214	∅ 10 x 140 mm, 100db/buc	1
39216	∅ 10 x 160 mm, 100db/buc	1
39217	∅ 10 x 200 mm, 100db/buc	1
39218	∅ 10 x 180 mm, 100db/buc	1
39219	∅ 10 x 220 mm, 100db/buc	1

SZIGETELÉS ALÁTÉT  
SPALATOR IZOLATII



39206	∅ 40mm	200db/buc	1
39207	∅ 60mm	100db/buc	1

KÖRKIVÁGÓ POLISZTIROLHOZ  
FREZÁ PENTRU POLISTIREN



24727	65 mm	1
<b>NEW</b> 24729	68 mm	1
24728	70 mm	1

MOSÓ RABICO  
RABICO MAȘINĂ DE SPĂLAT



42420	∅ 30 mm	1000 ks	AL rabico	1
42421	∅ 55 mm	100 ks	alátét szigetelés / izolație de spălare	1

GIPSKARTON EMEŐ  
CRIC PLACI GIPSCARTON



26775	Lift 153 - 344 cm Loading capacity max. 54 kg	1
-------	--	---

TELESZKÓPOS RÚD FÉM  
SUPPORTING POLE



max 30kg



52050	50 - 115 cm	10
52055	115 - 290 cm	10

TARTÓ  
SUPORT

FESTA®



80kg



36308	36x16.5x7.5cm	10
-------	---------------	----

KŐMŰVES KAMPÓSZEG  
CARLIG



Zn



37229	14,5 cm	25
-------	---------	----

KŐMŰVES KAMPÓSZEG  
CARLIG



Zn



37231	14 cm Különálló /separat	200
-------	--------------------------	-----

▼ KŐMŰVES KAMPÓSZEG  
CARLIG



**37232** 14,5 cm



▼ KŐMŰVES KAMPÓSZEG  
CARLIG



**37230** 6 db/buc, 16 cm



▼ ÁCSKAPOCS  
SCOABA



Zn



**37233** 320 x 10 mm  
**37234** 320 x 12 mm

▼ ÁCSKAPOCS  
SCOABA



Zn



**37235** 250 x 12 mm

▼ FERDE SZITA  
PLASA SARMA  
IMPLETITA

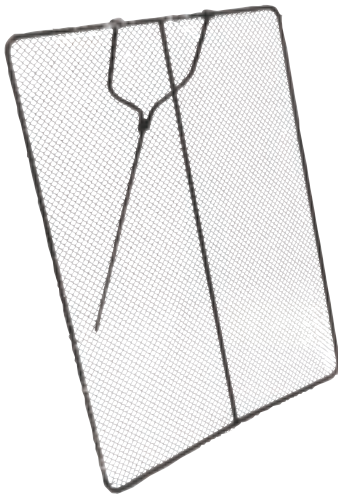

**37214** 1m x 1.3m x 10mm  
**37213** 1m x 1.3m x 15mm  
**37236** 0,8m x 1m x 10mm  
**37237** 0,8m x 1m x 12mm  
**37238** 0,8m x 1m x 16mm  
**37239** 0,8m x 1m x 20mm

▼ SZITA  
SITA PENTRU TENCUIALA



**37215** 500x500mm, 1mm  
**37216** 500x500mm, 2mm  
**37217** 500x500mm, 3mm  
**37218** 500x500mm, 4mm

▼ MŰGYANTA HENGER  
ROLA PLASTIC



**38950** Ø 69 mm x 12 mm, 25 cm  
**38951** Ø 69 mm x 12 mm, 40 cm  
**38952** Ø 122 mm x 34 mm, 25 cm  
**38953** Ø 122 mm x 34 mm, 40 cm  
**38954** Ø 122 mm x 34 mm, 60 cm

▼ KÜLSÓTALP TÜSKÉKKEL  
TALPA CU CRAMPOANE



**38970** tüské/crampoane 25 mm  
**38971** tüské/crampoane 30 mm



KŐPORSZORÓ  
TENCUIOR

NEW



37116



KŐPORSZORÓ  
TENCUIOR



37115



DRYVIT HÁLÓ  
PLASA PENTRU SCHELA



42120 2,5 m x 20 m, 80 g/m<sup>2</sup> green



HÁLÓT RABICO  
PLASĂ IZOLATI RABIO



42312 1m/ 50 bm 16 x 16



HUZAL RECÉZŐ  
SARMA KNURLING

NEW



42355 Ø 3,15 mm  
42356 Ø 2,0 mm



FA ESZTRICH  
SAPA DE LEMN



NEW



37120 200 cm



ÉGŐ, TÖMLŐ NÉLKÜL  
ARZATOR



**69900** Ø 35 mm, 550mm Tömlő nélkül/fara furtun  
**69901** Ø 35 mm, 550mm + Tömlő 3m/furtun 3m



10  
10

ÉGŐ, TÖMLŐ NÉLKÜL  
ARZATOR



**69902** Ø 55 mm, 550mm Tömlő nélkül/fara furtun  
**69903** Ø 55 mm, 550mm + Tömlő 3m/furtun 3m



10  
10

ÉGŐ, TÖMLŐ NÉLKÜL  
ARZATOR



**69905** Ø 55 mm, 850mm Tömlő nélkül/fara furtun  
**69906** Ø 55 mm, 850mm + Tömlő 3m/furtun 3m



10  
10

ÉGŐ, TÖMLŐ NÉLKÜL  
ARZATOR



**69915** 35 mm, 600mm Tömlő nélkül/fara furtun



10

ÉGŐ, TÖMLŐ NÉLKÜL  
ARZATOR



**69916** 35 mm, 250mm Tömlő nélkül/fara furtun



10

ÉGŐ, TÖMLŐ NÉLKÜL  
ARZATOR

NEW

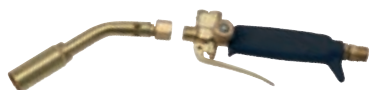

**69914** 300 mm, 2m hadice/ house,



10

TÖMLŐ  
FURTUN



**69910** 3 m  
**69911** 5 m  
**69912** 10 m



1  
1  
1

NYOMÁSSZABÁLYZÓ  
REGULATOR PRESIUNE

NEW



**69925** 50 mBar, trn  
**69926** 50 mBar, závit G 1/4"L



1  
1

NYOMÁSSZABÁLYZÓ  
REGULATOR PRESIUNE



**69908** 30 mBar, trn  
**69909** 30 mBar, filet G 1/4"L



1  
1

NYOMÁSSZABÁLYZÓ  
CASCA SUDURA



bemeneti nyomás/presiune admisie	25 bar
kimeneti nyomás/presiune evacuare	0,5-4,0 bar
névleges átfolyási sebesség/debit nominal	16 kg/h
bemeneti csatlakozás/conexiune admisie	W21,8x1/14" LH
kimeneti csatlakozás /conexiune evacuare	G 3/8" LH



**69907** P2 PB with pressure gauge

1

ONE WAY SZELEPL  
ONE WAY SUPAPA DE PRESIUNE

NEW



**69928** kijárat/ ieşire G 3/8L, 2 kg-os palack/ for 2 kg bottle

1

GIPSZELŐ EDÉNY  
VAS PENTRU GIPS

37121	Konikus/conic	25	
37122	Alacsony/joasa	25	
33275	Alacsony/joasa, rubber	1	

KŐMŰVES VÖDÖR  
GALEATA

39005	5 l	1	
39010	10 l	1	
39012	12 l	1	
39014	15 l Öntővel/cu gradatie	1	
39020	20 l	1	
39021	20 l Öntővel/cu gradatie	1	

HABARCSDÉZSA  
VAS PLASTIC

39045	45 l	∅ 54 x 27 cm	1	
39065	65 l	∅ 60 x 35 cm	1	
39090	90 l	∅ 66 x 35 cm	1	

HORGANYZOTT VÖDÖR  
GALEATA TABLA  
GALVANIZATA

39000	5 l	1	
39001	10 l	1	
39002	12 l	1	
39003	15 l	1	

Zn

HABARCSLÁDA  
VAS RECTANGULAR

39145	45 l	71 x 40 x 21 cm	1	
39165	65 l	71 x 40 x 30 cm	1	
39190	80 l	77 x 48 x 30 cm	1	
39191	90 l	78 x 48 x 31 cm	1	

KÖTÉLCSIGA Z 500  
ZIDARSKI KOTUR

26780	0,5 t A	horoggal/ cu cârling	1	
26781	0,5 t B	szem/ cu ochet	1	
26782	0,5 t C	horoggal és védővel/ cu cârling și protector	1	
26783	0,5 t D	szem és védővel/ cu ochet și protector	1	

CE

DÉZSA  
GALEATA

39192	30 l	1	
39193	45 l	1	

SITTESZSÁK  
SAL GUNOI CONSTRUCTII



<b>39194</b>	500x1100x0,160mm, 100l	1db/buc	50
<b>39196</b>	600x1200x0,160mm, 110l	1db/buc	50
<b>39198</b>	700x1100x0,160mm, 120l	1db/buc	50
<b>39200</b>	500x1100x0,200mm, 100l	1db/buc	50
<b>39202</b>	600x1200x0,200mm, 110l	1db/buc	50
<b>39204</b>	700x1100x0,200mm, 120l	1db/buc	50

SITTESZSÁK  
SAL GUNOI CONSTRUCTII

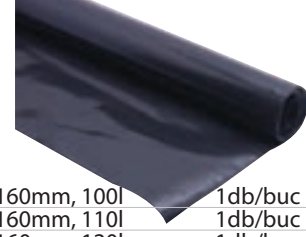

<b>39195</b>	500x1100x0,160mm, 100l	1db/buc	50
<b>39197</b>	600x1200x0,160mm, 110l	1db/buc	50
<b>39199</b>	700x1100x0,160mm, 120l	1db/buc	50
<b>39201</b>	500x1100x0,200mm, 100l	1db/buc	50
<b>39203</b>	600x1200x0,200mm, 110l	1db/buc	50
<b>39205</b>	700x1100x0,200mm, 120l	1db/buc	50

SZEMETESZSÁK  
SAC GUNOI

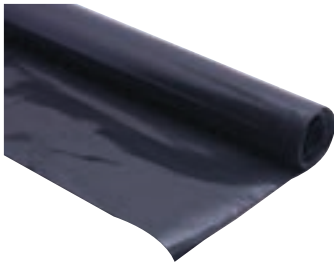

<b>38060</b>	700x1100x0,080mm	10db/buc	1
<b>38063</b>	700x1100x0,100mm	3db/buc	1
<b>38065</b>	700x1100x0,200mm	3db/buc	1

SZEMETESZSÁK  
SAC GUNOI



<b>38055</b>	120 x 100 x 0,080mm	5ks/pcs	1
--------------	---------------------	---------	---

SZEMETESZSÁK  
SAC GUNOI

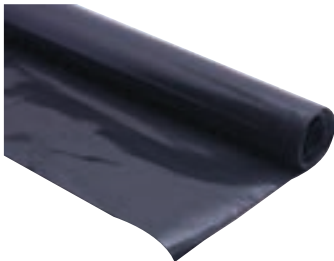

<b>38050</b>	500x600x0,040mm	25db/buc	1
<b>38052</b>	600x800x0,040mm	25db/buc	1
<b>38054</b>	700x1100x0,040mm	25db/buc	1

ZSUGOR FÓLIA HÁZ  
FOLIE STRETCH CASĂ



<b>38086</b>	1m x 0,1 m	150bm	1	
<b>38087</b>	1,2m x 0,1 m	150bm	1	
<b>38088</b>	1m x 0,1 m	150bm	fele ház/ jumătate din casa	1

ZSUGOR FÓLIA  
SĂRMĂ LIANT SPIRALĂ



**50050**

1

ZSUGOR FÓLIA  
FOLIE STRETCH



NEW

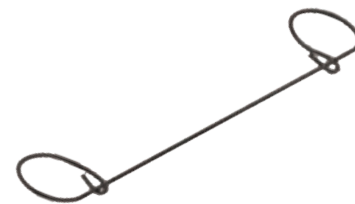

<b>38095</b>	50/200m-23μ	6
<b>38097</b>	10x150m/20μ	1
<b>38096</b>	fekete/black 50/200m/23μ	6

RÖGZÍTŐ HUZAL  
SĂRMĂ DE FIXARE



<b>42360</b>	1,25/ 125mm	1
<b>42361</b>	1,25/ 100 mm	1
<b>42362</b>	1,25/ 160mm	1
<b>42363</b>	1,25/ 80mm	1
<b>42364</b>	1,25/ 140mm	1

VAZÁČ ÚVAZKŮ - SVIDŘÍK  
SPIRAL BINDER WIRE



NEW



**50051**

1

PVC SZALAG  
PVC BENZI



**38925** 19mm x 0,13mm x 10m



RAGASZTÓSZALAG  
BANDA ADEZIVA



**38930** 19 mm x 5 m



PVC SZALAG KLT.  
BENZI PVC

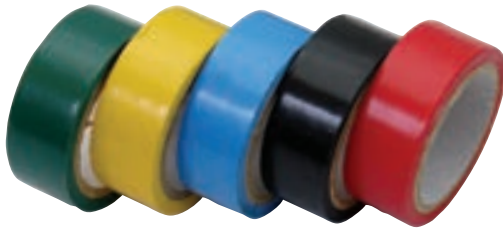

**38931** 5 db/buc 0,13 mm x 19 mm x 5 m



PVC SZALAG, FEKETE  
BANDA NEAGRA PVC



**38932** 0,13 mm x 19 mm x 10 m



TEFLON SZALAG  
BANDA TEFLON



**38933** 0,075 mm x 12 mm x 10 m



TEFLONSZALAG  
BANDA TEFLON



**38926** 2mm x 150m



ALU-TEXTILSZALAG  
BANDA ALU-TEX

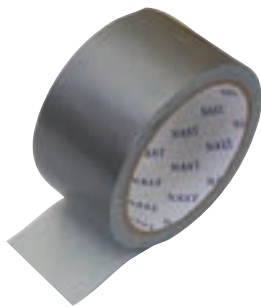

**NEW 38965** 30 mm x 10 m  
**38928** 50 mm x 10 m  
**38934** 50 mm x 45 m

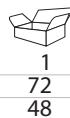

ÜVEGSZÁLAS RÁCSOSZALAG, ÖNTAPADÓS  
BANDA ADEZIVA PENTRU GIPS CARTON



**38935** 5 cm x 20 m  
**38937** 5 cm x 45 m  
**38939** 5 cm x 90 m  
**38940** 5 cm x 153 m

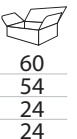

ÜVEGSZÁLAS SZALAG  
BANDA FIBRA



**38941** 50 mm x 25 m



PVC SZALAG  
BANDA PVC



**38942** 50 mm x 50 m





KÉTOLDALAS RAGASZTÓSZALAG, ÁTLÁTSZÓ  
BANDA DUBLU ADEZIVA

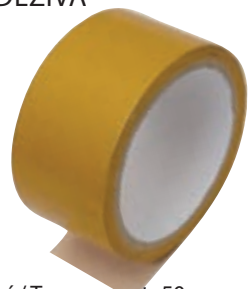

<b>38929</b>	Transparentní / Transparent	50 mm x 10 m	72
<b>NEW 38966</b>	Transparentní / Transparent	50 mm x 25 m	72

KORDON-SZALAG  
BANDA AVERTIZARE



<b>38944</b>	ZÁKAZ VSTUPU, SK	250 m	8
<b>38945</b>	VSTUP ZAKÁZÁN, CZ	250 m	8

KORDON-SZALAG  
BANDA AVERTIZARE



<b>38948</b>	250 m PIROS-FEHÉR / alb - rosu	8
--------------	--------------------------------	---

JELŐLŐ SZALAG  
BANDA MARCARE



<b>38949</b>	50mmx0.15mmx50m	36
--------------	-----------------	----

KITAKARÓSZALAG  
BANDA HARTIE MASCARE PROFÍ



<b>37263</b>	38 mm x 50 m	49
<b>37264</b>	48 mm x 50 m	42

ALU ÖNTAPADÓ FÓLIÁK  
BANDA ADEZIVA DE ALUMINIU



<b>NEW 38963</b>	48 mm x 10 m	1
<b>38943</b>	48 mm x 45 m	74

KORDON-SZALAG  
BANDA AVERTIZARE



<b>38946</b>	Fekete-sárga/negru-galben 250 m	8
--------------	---------------------------------	---

KORDON-SZALAG  
BANDA AVERTIZARE



<b>38947</b>	černo - sárga / negru-galben 33 m	jobbra	48
<b>38961</b>	černo - sárga / negru-galben 33m	balra	48

KREPP SZALAG  
BANDA ADEZIVA PENTRU MASCARE



<b>37255</b>	19 mm x 50 m	120
<b>37256</b>	25 mm x 50 m	96
<b>37257</b>	30 mm x 50 m	72
<b>37258</b>	38 mm x 50 m	60
<b>37259</b>	50 mm x 50 m	48

KITAKARÓSZALAG  
BANDA MASCARE



<b>NEW 37271</b>	38 mm x 20 m	24
<b>37270</b>	48 mm x 20 m	24
<b>NEW 37272</b>	48 mm x 50 m	24



**KITAKARÓSZALAG ABLAKHOZ  
BANDA PLASTIC MASCARE GEAMURI**

UV ellenálló/UV stable

ragadósság/stickiness  
39N/2,5cm

mü.a, fa ablakokhoz  
rame ferestre plastic sau lemn



**NEW 37282** 38 mm x 50 m  
**37273** 48 mm x 50 m

24  
24

**RAGASZTÓ SZALAG DUCT  
BANDA ADEZIVA PROFESIONALA**



**NEW 37276** 48 mm x 10 m  
**37275** 48 mm x 50 m

1  
24

**RAGASZTÓ SZALAG, UVEG  
BANDA NEAGRA RANFORSATA**



**38927** 19 mm x 10 m

10

**KÉTOLDALAS RAGASZTÓSZALAG, ÁTLÁTSZÓ  
BANDA DUBLU ADEZIVA**



**38924** 50 mm x 10 m

1

**CSÚSZÁSGÁTLÓSZALAG  
BANDA ANTI-ALUNTEGARE**



**37280** 25 mm x 0.8 mm x 15 m  
**37281** 50 mm x 0.8 mm x 15 m

72  
36

**PVC KÉTOLDALAS RAGASZTÓSZALAG  
PVC BANDA DUBLU**



**37266** 30 mm x 33 m  
**37267** 38 mm x 33 m  
**37268** 50 mm x 33 m

72  
36  
36

**RAGASZTÓSZALAG  
BANDA ADHEZIVĂ**



**37269** 48 mm x 50 mm

72

**PARTYTAPE**



**25700** fehér / alb 100 mm x 5 m

1

**TRUCKTAPE**



**25710** fehér / alb 100 mm x 5 m  
**25718** szürke / gri 100 mm x 5 m

1  
1

**VÉDELME PVC SAROK  
PROTEJAREA PVC COLȚUL**



**37284** 55 x 40 mm

1

PROFI KINYOMÓPISZTOLY  
PISTOL SKELETT PENTRU CARTUS

**FESTA®**



38012

6

PROFI KINYOMÓPISZTOLY  
PISTOL SKELETT PENTRU CARTUS

**FESTA®**



38001

12

PROFI KINYOMÓPISZTOLY  
PISTOL SKELETT PENTRU CARTUS

**FESTA®**



38013

6

KINYOMÓPISZTOLY LÉPTETŐS  
PISTOL CU PIEDICA



38010

24

KINYOMÓ PISZTOLY LÉPTETŐS,  
HORGANYZOTT  
PISTOL PENTRU FIXARI CHIMICE

**FESTA®**



38020

12

KINYOMÓPISZTOLY - ERŐSÍTETT  
PISTOL SKELETT PENTRU CARTUS



38002 Hatszögű/ax hexagonal

24

PURHAB KINYOMÓ ALUMÍNIUMBÓL  
PISTOL SKELETT PENTRU CARTUS ALU

**FESTA®**



38004

600 ml

12

38005

310 ml

20

38014

adapter 3 db/buc

50

KINYOMÓPISZTOLY 210 ML (105+105)  
PISTOL 2 COMPONENTE PENTRU SPUMA 210ML

**FESTA®**



38019

6

KINYOMÓPISZTOLY - KRÓMOZOTT  
PISTOL SKELETT PENTRU CARTUS



38007

24

KINYOMÓPISZTOLY - LÉPTETŐS  
PISTOL PENTRU CARTUS



38006

24

KINYOMÓPISZTOLY FÉLIG ZÁRT  
PISTOL SKELETT PENTRU CARTUS



38008



KINYOMÓPISZTOLY - FÉLIG ZÁRT  
PISTOL SKELETT PENTRU CARTUS



38009



KINYOMÓPISZTOLY - FÉLIG ZÁRT  
PISTOL PENTRU CARTUS SEMI-INCHIS



38000



KINYOMÓPISZTOLY - MŰANYAGBÓL  
PISTOL SKELETT PENTRU CARTUS



38003 Hatszögű/ax hexagonal



KINYOMÓPISZTOLY  
PISTOL SCURT PVC PENTRU SPUMA



38011



PURHAB KINYOMÓPISZTOLY  
PISTOL METALIC PENTRU SPUMA



38016



PURHAB KINYOMÓ TEFLONOS  
PISTOL SPUMA POLIURETANICA TEFLON



38017



PURHAB KINYOMÓ  
PISTOL PENTRU SPUMA PUR



38015



PURHAB KINYOMÓ PISZTOLY  
PISTOL SPUMA POLIURETANICA



38018



PURHAB PISZTOLY TARTALÉK FŰVÓKA  
DUZA DE SCHIMB PENTRU PISTOL SPUMA



38030 pisztoly / pistol 38015, 38016, 38017, 38018



PURHAB KINYOMÓ  
PISTOL PENTRU SPUMA PUR

FESTA®



38022 ABS



20

PURHAB KINYOMÓ  
PISTOL PENTRU SPUMA PUR

FESTA®



38023 600 mm



20

PURHAB KINYOMÓ  
PISTOL PENTRU SPUMA PUR



38021



20

FUGA KINYOMÓ TASAK  
PLASA CONICA PENTRU UMLUT ROSTURI



38042



1

RAGASZTÓ PISZTOLY  
PISTOL DE LIPIT



89970 15W / 240V, Ø 7,2 mm



20

RAGASZTÓ PISZTOLY  
PISTOL DE LIPIT



89973 60W / 240V, Ø 11,2 mm



20

OLVASZTÓ PÁLCIKA, ÁTLÁTSZÓ  
REZERVE BATON PLASTIC, TRANSPARENT



89980 Ø 7,2 x 100 mm, 12db/buc



1

OLVASZTÓ PÁLCIKA, ÁTLÁTSZÓ  
REZERVE BATON PLASTIC, TRANSPARENT

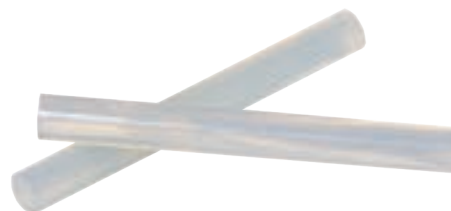

89985 Ø 11,2 x 200 mm, 10db/buc  
89987 Ø 11,2 x 200 mm, 1kg



1

1

ECSET  
PENSULE



<b>52202</b>	1" x 12,5 x 38 mm	1
<b>52203</b>	1,5" x 13 x 38 mm	1
<b>52204</b>	2" x 14 x 44 mm	1
<b>52205</b>	2,5" x 16 x 44 mm	1
<b>52206</b>	3" x 17 x 52 mm	1
<b>52207</b>	4" x 18 x 52 mm	1

ECSET  
PENSULE



<b>52212</b>	20 x 15 x 40 mm	1	<b>52216</b>	60 x 15 x 60 mm	1
<b>52213</b>	30 x 15 x 45 mm	1	<b>52217</b>	70 x 15 x 65 mm	1
<b>52214</b>	40 x 15 x 45 mm	1	<b>52218</b>	80 x 15 x 65 mm	1
<b>52215</b>	50 x 15 x 50 mm	1	<b>52220</b>	100 x 15 x 70 mm	1



SAROK ECSET  
PENSULA PENTRU VOPSIT CALORIFER



<b>52283</b>	1,0" x 10 x 44 mm	1
<b>52284</b>	1,5" x 10 x 44 mm	1
<b>52285</b>	2,0" x 10 x 44 mm	1
<b>52286</b>	2,5" x 10 x 50 mm	1
<b>52288</b>	3,0" x 10 x 50 mm	1

ECSET KLT  
SET PENSULE



Műanyag markolat/maner de plastic



<b>52070</b>	3 db/buc (20, 30, 50 mm)	50
--------------	--------------------------	----

ECSET KLT  
SET PENSULE



Műanyag markolat/maner de plastic



<b>52071</b>	5 db/buc (15, 25, 40, 60, 80 mm)	50
--------------	----------------------------------	----

KÖRKEFE  
BIDINEA



<b>52075</b>	Ø 120 mm	12
--------------	----------	----

KEFE  
BIDINEA



<b>52076</b>	170 x 70 mm	16
--------------	-------------	----

KÖRKEFE  
BIDINEA



<b>52077</b>	Ø 105 mm	12
--------------	----------	----

KEFE  
BIDINEA



<b>52078</b>	170 x 70 mm	12
--------------	-------------	----

FESTÉK ÉS LAKK KAPARÓ  
SPACLU



<b>37005</b>		12
--------------	--	----

FESTŐHENGEREK KIVÁLASZTÁSA  
TRAFLET

ANYAG MATERIAL	SZÁL HOSSZ. DIMENZIUNI ROLA	FESTÉKEK VAGY LAKKOK VOPSELE SI LACURI												
		DISZPERZIÓS DISPERSII	ROZSDAGÁTLÓ ANTICOROZIVE	GYANTÁS RASINI	OLAJFESTÉK ULEIURI	VÍZES BÁZISÚ LAVABILE	POLIÉSZTER VOPSELEPOLIES-	KÖTŐANYAG ADEZIVI	LAZUR LACURI	LATEX VOPSELE LATEX	EPOXY EPOXIDICE	KÉT KOMPONEN- SŰ	SŰRŰ ANYAGOK VOPSELE USOARE	AKRIL VOPSELE ACRI-
PES	20	✓								✓			✓	
PES	20	✓	✓			✓				✓				✓
PAC	18	✓								✓				
PAC	12, 13	✓								✓				
PAD	18, 21	✓								✓				
PAD	13	✓	✓							✓				
BÁRÁNY PIELE	23	✓								✓				
NYLON	13		✓	✓	✓	✓	✓			✓	✓	✓		
VELOUR	4		✓	✓			✓				✓	✓	✓	
MICROFIBRE	10					✓			✓	✓				
MOLITAN				✓		✓								✓

FESTŐHENGER SZETT  
SET TRAFLET

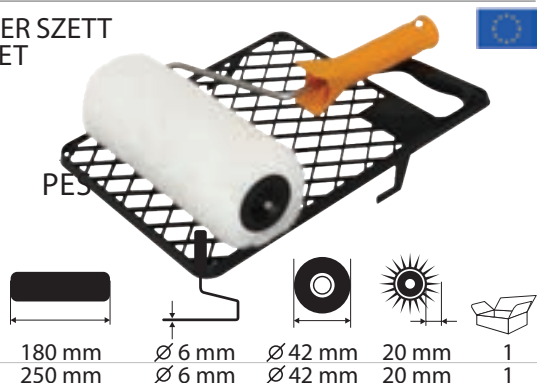

FESTŐHENGER SZETT  
SET TRAFLET



FESTŐHENGER SZETT  
SET TRAFLET



POLYESTER FESTŐHENGER  
TRAFLET DIN POLYESTER



PES



<b>52410</b>	100mm	∅ 6mm	∅ 17mm	16mm	50
<b>52411</b>	120mm	∅ 6mm	∅ 30mm	16mm	50
<b>52412</b>	180mm	∅ 8mm	∅ 48mm	16mm	50
<b>52413</b>	250mm	∅ 8mm	∅ 48mm	16mm	10
<b>52414</b>	270mm	∅ 8mm	∅ 54mm	16mm	10

POLYACRYL FESTŐHENGER  
TRAFLET DIN ACRYLIC



PAC



<b>52331</b>	100 mm	∅ 6 mm	∅ 17 mm	12 mm	50
<b>52363</b>	150 mm	∅ 6 mm	∅ 17 mm	12 mm	50
<b>52332</b>	120 mm	∅ 6 mm	∅ 30 mm	12 mm	50
<b>52333</b>	180 mm	∅ 8 mm	∅ 48 mm	12 mm	10
<b>52334</b>	250 mm	∅ 8 mm	∅ 48 mm	12 mm	10

POLYACRYL FESTŐHENGER  
TRAFLET DIN ACRYLIC



PAC

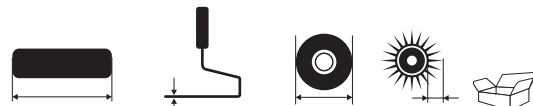

<b>52325</b>	180 mm	∅ 8 mm	∅ 48 mm	18 mm	10
<b>52326</b>	250 mm	∅ 8 mm	∅ 48 mm	18 mm	10
<b>52355</b>	180 mm	∅ 8 mm	∅ 44 mm	13 mm	10

POLYACRYL FESTŐHENGER  
TRAFLET DIN ACRYLIC

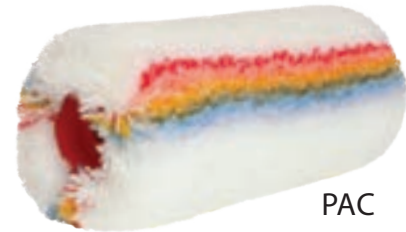

PAC



<b>52327</b>	<i>polster 5</i>	180 mm	∅ 8 mm	∅ 54 mm	18 mm	10
<b>52328</b>	<i>polster 5</i>	250 mm	∅ 8 mm	∅ 54 mm	18 mm	10
<b>52442</b>	<i>polster 7</i>	180 mm	∅ 8 mm	∅ 67 mm	18 mm	10
<b>52456</b>	<i>polster 7</i>	250 mm	∅ 8 mm	∅ 67 mm	18 mm	10

POLYACRYL FESTŐHENGER  
TRAFLET DIN ACRYLIC



PAC



<b>52391</b>	<i>polster 5</i>	250 mm	∅ 8 mm	∅ 54 mm	18 mm	10
<b>52409</b>	<i>polster 5</i>	180 mm	∅ 8 mm	∅ 54 mm	18 mm	10

POLYAMID FESTŐHENGER  
TRAFLET DIN POLYAMIDA



PAD



<b>52428</b>	<i>polster 7</i>	250 mm	∅ 8 mm	∅ 67 mm	18 mm	10
--------------	------------------	--------	--------	---------	-------	----

SAROK FESTÉKHENGER  
TRAFLET PENTRU CULTURI, DIN POLYACRYLE



PAC



<b>52601</b>	with handle	∅ 6 mm	18 mm	1
<b>52330</b>	spare roller	∅ 6 mm	18 mm	1

POLYESTER FESTŐHENGER  
TRAFLET PENTRU CULTURI, DIN POLYESTER



PES

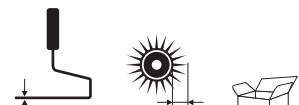

<b>52604</b>	with handle	∅ 6 mm	20 mm	1
<b>52371</b>	spare roller	∅ 6 mm	20 mm	1



POLYAMID FESTŐHENGER  
TRAFALLET DIN POLYAMIDA

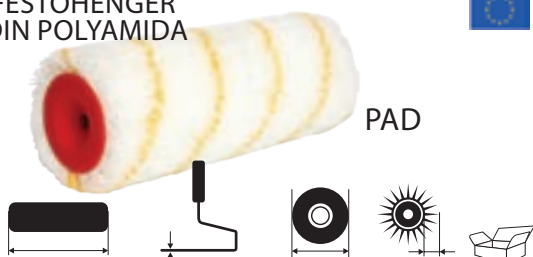

<b>52425</b>	250 mm	∅ 8 mm	∅ 56 mm	13 mm	10
<b>52426</b>	250 mm	∅ 8 mm	∅ 48 mm	13 mm	10
<b>52375</b>	180 mm	∅ 8 mm	∅ 42 mm	18 mm	10
<b>52376</b>	250 mm	∅ 8 mm	∅ 42 mm	18 mm	10

POLYESTER FESTŐHENGER  
TRAFALLET DIN POLYESTER

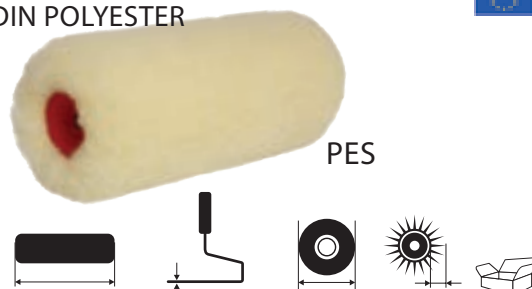

<b>52315</b>	<i>polster 5</i>	180 mm	∅ 8 mm	∅ 54 mm	20 mm	10
<b>52318</b>	<i>polster 5</i>	250 mm	∅ 8 mm	∅ 54 mm	20 mm	10

POLYACRYL FESTŐHENGER  
TRAFALLET DIN ACRYLIC



<b>52335</b>	<i>polster 5</i>	180 mm	∅ 8 mm	∅ 54 mm	18 mm	10
<b>52338</b>	<i>polster 5</i>	250 mm	∅ 8 mm	∅ 54 mm	18 mm	10
<b>52339</b>		180 mm	∅ 8 mm	∅ 42 mm	18 mm	10
<b>52340</b>		250 mm	∅ 8 mm	∅ 42 mm	18 mm	10

POLYAMID FESTŐHENGER  
TRAFALLET DIN POLYAMIDA

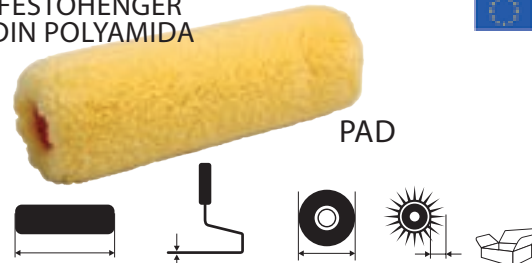

<b>52385</b>	<i>polster 4</i>	180 mm	∅ 8 mm	∅ 53 mm	18 mm	10
<b>52388</b>	<i>polster 4</i>	250 mm	∅ 8 mm	∅ 53 mm	18 mm	10
<b>52435</b>		180 mm	∅ 8 mm	∅ 44 mm	13 mm	10
<b>52436</b>		250 mm	∅ 8 mm	∅ 44 mm	13 mm	10

POLYAMID FESTŐHENGER  
TRAFALLET DIN POLYAMIDA

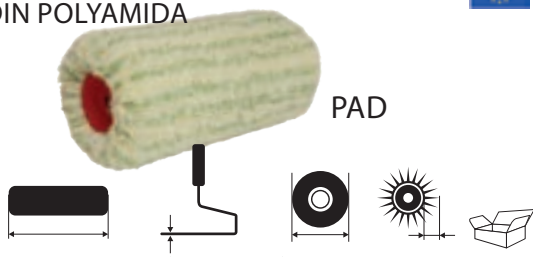

<b>52393</b>		150 mm	∅ 6 mm	∅ 30 mm	13 mm	50
<b>52395</b>	<i>polster 4</i>	180 mm	∅ 8 mm	∅ 53 mm	21 mm	10
<b>52398</b>	<i>polster 4</i>	250 mm	∅ 8 mm	∅ 53 mm	21 mm	10
<b>52399</b>	<i>polster 10</i>	250 mm	∅ 8 mm	∅ 64 mm	21 mm	10

FESTŐHENGER BÁRÁNYGYAPJÚ  
TRAFALLET DIN PIELE DE MIEL

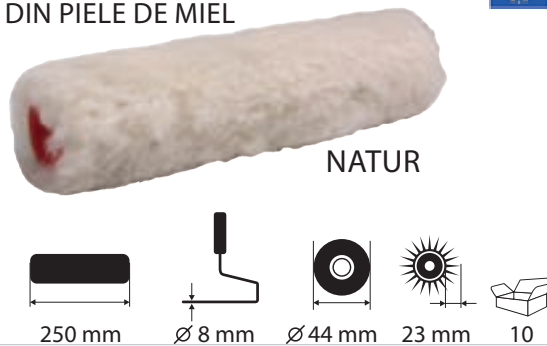

<b>52419</b>		250 mm	∅ 8 mm	∅ 44 mm	23 mm	10
--------------	--	--------	--------	---------	-------	----

POLYESTER FESTŐHENGER  
TRAFALLET DIN POLYESTER

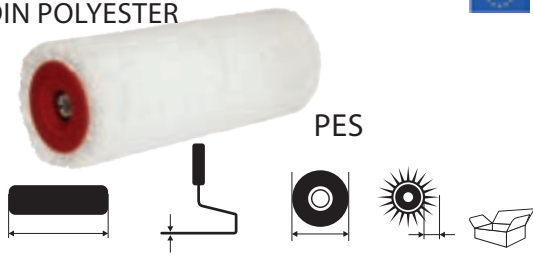

<b>52441</b>		100 mm	∅ 6 mm	∅ 17 mm	10 mm	50
<b>52438</b>		120 mm	∅ 6 mm	∅ 30 mm	10 mm	50
<b>52439</b>		180 mm	∅ 8 mm	∅ 48 mm	10 mm	10
<b>52440</b>		250 mm	∅ 8 mm	∅ 48 mm	10 mm	10

LAKKOZÓ FESTÉKHENGER,  
TRAFALLET DE NYLON, PENTRU LAC

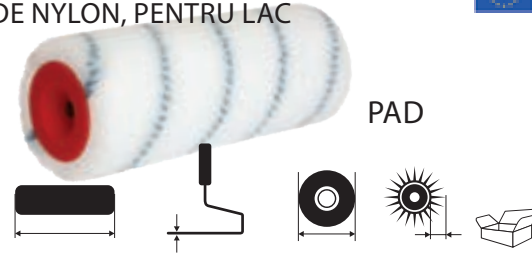

<b>52421</b>		100 mm	∅ 6 mm	∅ 17 mm	13 mm	50
<b>52422</b>		120 mm	∅ 6 mm	∅ 30 mm	13 mm	50
<b>52423</b>		180 mm	∅ 8 mm	∅ 48 mm	13 mm	10
<b>52424</b>		250 mm	∅ 8 mm	∅ 48 mm	13 mm	10

POLYESTER FESTŐHENGER  
TRAFALLET DIN POLYESTER

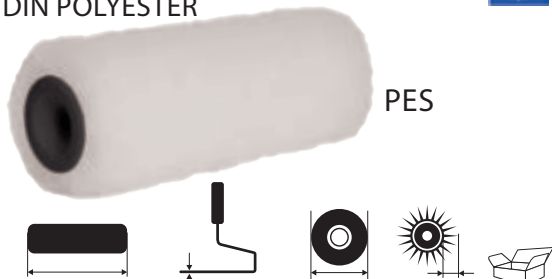

<b>52305</b>		180 mm	∅ 6 mm	∅ 42 mm	20 mm	10
<b>52306</b>		240 mm	∅ 6 mm	∅ 42 mm	20 mm	10

LAKKOZÓ FESTÉKHENGER VELOUR  
TRAFALLET DIN VELUR, PENTRU LAC

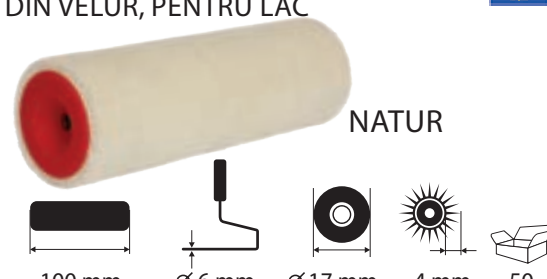

<b>52461</b>		100 mm	∅ 6 mm	∅ 17 mm	4 mm	50
<b>52465</b>		180 mm	∅ 8 mm	∅ 48 mm	4 mm	10
<b>52466</b>		250 mm	∅ 8 mm	∅ 48 mm	4 mm	10

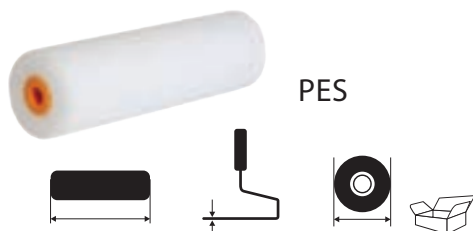
LAKKOZÓ FESTÉKHENGER  
TRAFLET DIN BURETE FINDERPT, PENTRU LAC

		50 mm	∅ 6 mm	∅ 35 mm	50
<b>52470</b>	rovny/straight	50 mm	∅ 6 mm	∅ 35 mm	50
<b>52471</b>	rovny/straight	100 mm	∅ 6 mm	∅ 35 mm	50
<b>52482</b>	obly/rounded	100 mm	∅ 6 mm	∅ 35 mm	50

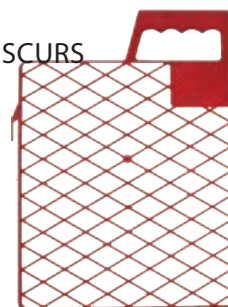
RÁCS  
GRATAR PENTRU SCURS

<b>52651</b>	110 mm x 200 mm	100
<b>52652</b>	230 mm x 250 mm	100
<b>52656</b>	270 mm x 290 mm	100

MARKOLAT  
MANER OTEL-PLASTIC PENTRU TRAFLET

<b>52640</b>	5 cm / ∅ 6 mm	100	<b>52630</b>	18 cm / ∅ 6 mm	100
<b>52645</b>	8,5 cm / ∅ 6 mm x 27 cm	100	<b>52635</b>	25 cm / ∅ 6 mm	100
<b>52649</b>	8,5 cm / ∅ 6 mm x 42 cm	100	<b>52620</b>	18 cm / ∅ 8 mm	50
<b>52629</b>	15 cm / ∅ 6 mm	100	<b>52625</b>	25 cm / ∅ 8 mm	50

FESTŐ VÖDÖR  
RECIPIENT VOPSEA

<b>52694</b>	8 l	25
<b>52695</b>	12 l	20

TÁL  
TAVA PENTRU VOPSEA

<b>52659</b>	100 x 200 mm	50 mm	100
<b>52660</b>	140 x 290 mm	100 mm	1
<b>52662</b>	150 x 270 mm	100 mm	100
<b>52665</b>	210 x 320 mm	150 mm	1
<b>52666</b>	260 x 290 mm	180 mm	50
<b>52670</b>	270 x 370 mm	180 mm	1
<b>52671</b>	330 x 340 mm	250 mm	50

UNIVERZÁLIS TAKARÓFÓLIA  
FOLIE PROTECTIE

<b>37250</b>	4x5 m	0,007 mm	100
<b>37251</b>	4x12,5 m	0,007 mm	40
<b>37252</b>	2x50 m	0,007 mm role/roll	20

UNIVERZÁLIS TAKARÓFÓLIA  
FOLIE PROTECTIE

NEW

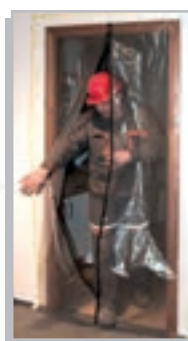

<b>37248</b>	1,2 x 2,2 m	100 µm	maskovací páska 45 mm x 25 m	10
--------------	-------------	--------	------------------------------	----

UNIVERZÁLIS TAKARÓFÓLIA  
FOLIE PROTECTIE

thickness 0,030mm

<b>37253</b>	4x5 m	0,030 mm	10
--------------	-------	----------	----

TAKARÓFÓLIA TEKERCSEBEN  
FOLIE PROTECTIE AUTOADEZIVA

<b>37242</b>	30 cm x 30 m	60
<b>37243</b>	55 cm x 30 m	60
<b>37244</b>	110 cm x 30 m	30
<b>37245</b>	140 cm x 30 m	30
<b>37246</b>	180 cm x 15 m	30
<b>37247</b>	240 cm x 15 m	30

HULLÁMPAPÍR  
CARTON GUDRONAT ONDULAT

<b>54008</b>	1 x 10m	1
--------------	---------	---

## PE BORITÓPONYVA PRELATE POLIETILENA

kétszeres forrasztású szegély polypropylén zsinórral  
ezüst réteg a napsugarak jobb visszaverődésére  
ALU szemek 1 méterenként

mansete cu dubla lipire si snur din polipropilena  
strat argintiu pentru cresterea reflexiei solare  
capse de aluminiu din metru in metru

### LETAKARÓ PONYVA PE PRELATE



kék-zelená  
albastru-verde



<b>25369</b>	2 x 2 m	50	<b>25374</b>	4 x 6 m	5
<b>25370</b>	2 x 3 m	20	<b>25376</b>	5 x 8 m	5
<b>25371</b>	3 x 4 m	10	<b>25378</b>	6 x 10 m	2
<b>25372</b>	3 x 5 m	10	<b>25379</b>	8 x 12 m	2
<b>25373</b>	4 x 5 m	10	<b>25380</b>	10 x 15 m	2

### LETAKARÓ PONYVA STANDARD 70G/M<sup>2</sup> PE PRELATE STANDARD 70G/M<sup>2</sup>



kék-ezüst  
albastru-argint



<b>25006</b>	2 x 3 m	50	<b>25040</b>	5 x 8 m	5
<b>25012</b>	3 x 4 m	20	<b>25048</b>	6 x 8 m	5
<b>25015</b>	3 x 5 m	10	<b>25060</b>	6 x 10 m	5
<b>25020</b>	4 x 5 m	10	<b>25096</b>	8 x 12 m	2
<b>25024</b>	4 x 6 m	10	<b>25150</b>	10 x 15 m	2
<b>25030</b>	5 x 6 m	10	<b>25153</b>	15 x 20 m	1

### LETAKARÓ PONYVA STANDARD 70G/M<sup>2</sup> PE PRELATE STANDARD 70G/M<sup>2</sup>



zöld-zöld  
verde-verde



<b>25180</b>	2 x 3 m	50	<b>25186</b>	5 x 8 m	5
<b>25181</b>	3 x 4 m	20	<b>25188</b>	6 x 10 m	5
<b>25182</b>	3 x 5 m	10	<b>25189</b>	8 x 12 m	2
<b>25183</b>	4 x 5 m	10	<b>25190</b>	10 x 15 m	2
<b>25184</b>	4 x 6 m	10			

### LETAKARÓ PONYVA PROFI 140G/M<sup>2</sup> PE PRELATE PROFI 140G/M<sup>2</sup>



kék-ezüst  
albastru-argint



<b>25206</b>	2 x 3 m	25	<b>25240</b>	5 x 8 m	4
<b>25212</b>	3 x 4 m	10	<b>25248</b>	6 x 8 m	3
<b>25215</b>	3 x 5 m	10	<b>25260</b>	6 x 10 m	3
<b>25220</b>	4 x 5 m	8	<b>25296</b>	8 x 12 m	2
<b>25224</b>	4 x 6 m	6	<b>25350</b>	10 x 15 m	1
<b>25230</b>	5 x 6 m	5			

### LETAKARÓ PONYVA PROFI 200G/M<sup>2</sup> PE PRELATE PROFI 200G/M<sup>2</sup>



zöld-zöld  
verde-verde



<b>25160</b>	2 x 3 m	15	<b>25167</b>	6 x 8 m	2
<b>25162</b>	3 x 5 m	5	<b>25169</b>	8 x 12 m	1
<b>25163</b>	4 x 5 m	4	<b>25170</b>	10 x 15 m	1
<b>25164</b>	4 x 6 m	3			

### LETAKARÓ PONYVA 120G/M<sup>2</sup> PE PRELATE 120G/M<sup>2</sup>



kék-ezüst  
albastru-argint



<b>25003</b>	Ø 3,6 m	10
<b>25004</b>	Ø 4,5 m	10
<b>25005</b>	Ø 5,5 m	5
<b>25002</b>	Ø 6,5 m	4

### GYŰRŰK PE PONYVÁRA CAPSE PENTRU PRELATE PE

NEW



**25001** 10 db/buc

1

### FESZÍTŐ PE PONYVÁK INTINZĂTORUL PENTRU Prelate PE

NEW



**25400** 20 cm 4 db/buc

1

FESZITŐ CSAVAR  
CATARAMA CORDELINA

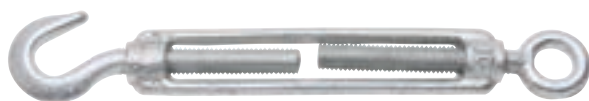

Zn

DIN 1480

50100	5 x 70 mm	10	50104	12 x 200 mm	10
50101	6 x 90 mm	10	50106	16 x 230 mm	10
50102	8 x 125 mm	10	50108	20 x 220 mm	10
50103	10 x 150 mm	10			

MENETES KARABÍNÉR  
CUPLAJ RAPID



Zn

51241	4 mm	10	51245	8 mm	10
51242	5 mm	10	51246	10 mm	10
51243	6 mm	10	51247	12 mm	10
51244	7 mm	10			

KÖTÉL BILINCS  
CLEMA FRANGHIE

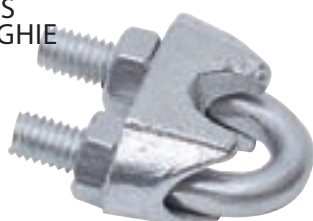

Zn

51280	3 mm	10	51284	10 mm	10
51281	5 mm	10	51286	12 mm	10
51282	6 mm	10	51287	14 mm	10
51283	8 mm	10	51288	16 mm	10

SZEMES ANYA  
PIULITA-INEL



Zn

DIN 582

51320	6 mm	10	51324	14 mm	10
51321	8 mm	10	51325	16 mm	10
51322	10 mm	10	51327	20 mm	10
51323	12 mm	10			

FORGÓ SZEM  
INEL



Zn

51225	3,8 mm	10			
51226	4,5 mm	10			
51227	6,0 mm	10			

ALUMÍNIUM KARABÍNÉR  
CARABINE ALUMINIU



Zn

DIN 5299 C

51204	4 mm	10	51208	8 mm	10
51205	5 mm	10	51209	9 mm	10
51206	6 mm	10	51210	10 mm	10
51207	7 mm	10	51211	11 mm	10
			51212	12 mm	10

S KAPOCS  
CARLIG



Zn

51271	3 mm	10	51275	7 mm	10
51272	4 mm	10	51276	8 mm	10
51273	5 mm	10	51278	10 mm	10
51274	6 mm	10			

SZEMES CSAVAR  
SURUB CAP-INEL



Zn

DIN 5820

51300	6 mm	10	51305	16 mm	10
51301	8 mm	10	51306	18 mm	10
51302	10 mm	10	51307	20 mm	10
51303	12 mm	10	51308	22 mm	10
51304	14 mm	10			

ALUMÍNIUM KARABÍNÉR  
CARABINE ALUMINIU



Zn

51220	53 mm	10			
51221	67 mm	10			
51222	76 mm	10			

SEKLI  
ETRIER DE RACORDARE OMEGA



Zn

51230	5 mm	10	51233	10 mm	10
51231	6 mm	10	51234	12 mm	10
51232	8 mm	10	51235	14 mm	10

RÖVID SZEMŰ LÁNC  
LANT OCHIURI SCURTE



Zn

DIN 5685 A



51402	2 x 12mm/110 m	1	51406	6 x 24mm/18 m	1
51403	3 x 16mm/60 m	1	51407	7 x 29mm/16 m	1
51404	4 x 21mm/40 m	1	51408	8 x 32mm/10 m	1
51405	5 x 23mm/30 m	1	51410	10 x 39mm/10 m	1

HOSSZÚ SZEMŰ LÁNC  
LANT OCHIURI LUNGI



Zn

DIN 5685 C



51412	2 x 12mm/80 m	1	51416	6 x 43mm/18 m	1
51413	3 x 26mm/60 m	1	51417	7 x 50mm/16 m	1
51414	4 x 32mm/38 m	1	51418	8 x 54mm/10 m	1
51415	5 x 35mm/32 m	1	51420	10 x 65mm/10 m	1

DRÓTKÖTÉL ÖSSZEKÖTŐ  
CONECTOR FRANGHII SI CABLURI



Zn

DIN 5685 C



51342	∅ 2 mm	10	51346	∅ 6 mm	10
51343	∅ 3 mm	10	51347	∅ 8 mm	10
51344	∅ 4 mm	10	51348	∅ 10 mm	10
51345	∅ 5 mm	10			

KÖTÉL SZEM  
INELE SIGURANTA FRANGHII



Zn



51250	∅ 3 mm	10	51258	∅ 16 mm	10
51251	∅ 4 mm	10	51259	∅ 18 mm	10
51252	∅ 5 mm	10	51260	∅ 20 mm	10
51253	∅ 6 mm	10	51261	∅ 22 mm	10
51254	∅ 8 mm	10	51262	∅ 24 mm	10
51255	∅ 10 mm	10	51263	∅ 26 mm	10
51256	∅ 12 mm	10	51264	∅ 28 mm	10
51257	∅ 14 mm	10	51265	∅ 30 mm	10

ACÉL HUZAL Zn  
CABLU IMPLFIT DE OTEL GALVANIZAT



Zn



51100	∅ 1 mm / 500 m	1	51106	∅ 5 mm / 75 m	1
51101	∅ 1,2 mm / 500 m	1	51107	∅ 6 mm / 75 m	1
51102	∅ 1,5 mm / 500 m	1	51130	∅ 8 mm / 75 m	1
51103	∅ 2 mm / 200 m	1	51131	∅ 10 mm / 50 m	1
51104	∅ 3 mm / 200 m	1	51132	∅ 12 mm / 50 m	1
51105	∅ 4 mm / 100 m	1			

LÁNC VICTOR  
LANT VICTOR



Zn

DIN 5686



51430	1,4mm/150 m	1	51434	2,2mm/80 m	1
51431	1,6mm/150 m	1	51435	2,5mm/70 m	1
51432	1,8mm/130 m	1	51436	2,8mm/50 m	1
51433	2,0mm/118 m	1	51439	3,8mm/30 m	1

LÁNC MŰANYAG  
LANT DE PLASTIC



51450 6 mm/25 m piros-fehér/ rosu - alb



1

DRÓTKÖTÉL ÖSSZEKÖTŐ  
CONECTOR FRANGHII SI CABLURI



Zn

DIN 5685 C



51335	∅ 2 mm	10	51339	∅ 6 mm	10
51336	∅ 3 mm	10	51340	∅ 8 mm	10
51337	∅ 4 mm	10	51341	∅ 10 mm	10
51338	∅ 5 mm	10			

BEMUTATÓ ÁLLVÁNY  
STAND PROMOTIONAL

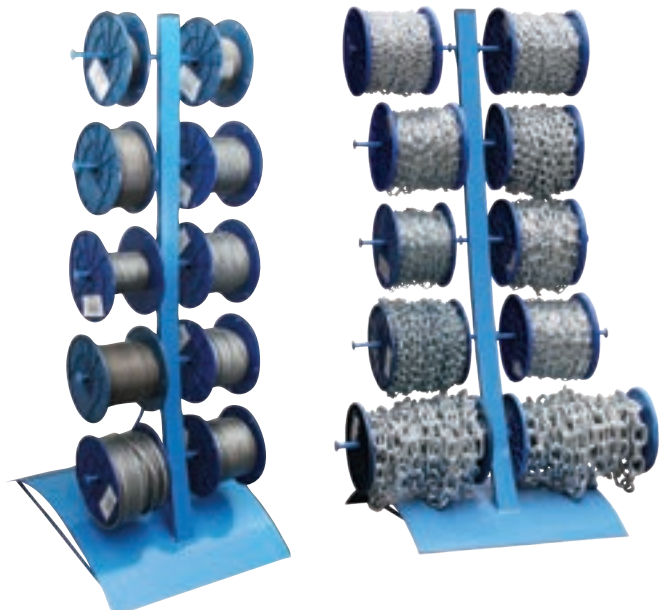

51199 állvány - láncok / stand - lant  
51198



1

ACÉL HUZAL PVC  
CABLU IMPLETIT DE OTEL MANTA PVC



51108	∅ 2/3 mm / 200 m	1
51109	∅ 3/4 mm / 100 m	1
51110	∅ 4/5 mm / 75 m	1
51111	∅ 5/6 mm / 50 m	1



ROZSDAMENTES ACÉL HUZAL  
CABLU IMPLETIT DE OTEL INOX



51120	∅ 1 mm / 300 m	1	51124	∅ 3 mm / 200 m	1
51121	∅ 1,2 mm / 300 m	1	51125	∅ 4 mm / 100 m	1
51122	∅ 1,5 mm / 300 m	1	51126	∅ 5 mm / 75 m	1
51123	∅ 2 mm / 200 m	1	51127	∅ 6 mm / 75 m	1



INOX



HALOGEN LAMPA  
HALOGEN CU SUPORT

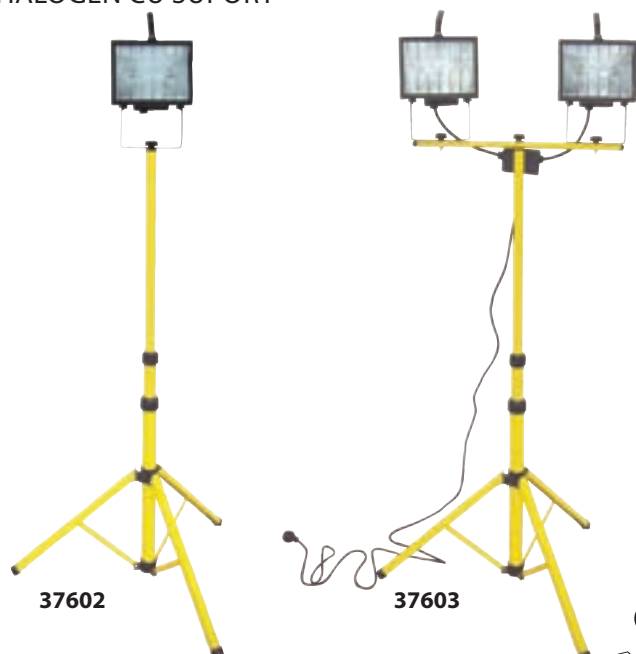

37602	500 W	2
37603	2 x 500 W	2



HALOGEN LAMPA  
HALOGEN CU SUPORT



37600	150 W	12
37601	500 W	8



CSÖRLŐ (KÖTÉLLEL ÉS KAMPÓVAL)  
TROLIU MANUAL



Zn



26705	450 kg	10 m / 4 mm	1
26706	900 kg	10 m / 5 mm	4
26707	1350 kg	10 m / 6 mm	4
26720	300 kg	10 m / 4 mm	8
26721	500 kg	10 m / 4 mm	8
26722	800 kg	10 m / 5 mm	4

HALOGEN LAMPA  
HALOGEN CU SUPORT



37611	20 W - 1300 lumen, IP 65, kabel 1,5 m	1
37615	20 W - 1300 lumen, IP 65, kabel 3 m	1
37616	2 x 20 W - 2 x 1300 lumen, IP 65, kabel 3 m	1



HALOGEN IZZÓ  
LAMPÁ HALOGEN



37604	150 W	1
37606	300 W	1
37605	500 W	3



ZSALUZAT TÁVTARTÓ, ÁLLÍTHATÓ  
POPI COFRAJ



48453	180/ 320 cm
48454	200/ 360 cm
48455	250/ 440 cm
48456	260/ 380 cm
48457	220/ 400 cm

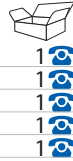

KÖRMÖK FEDEZÉSÉRE  
CUIE PENTRU ACOPERIREA

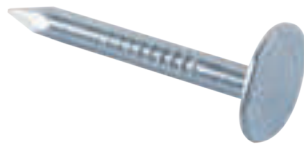

55486	25 mm Zn
55487	32 mm Zn
55545	25 mm
55546	32 mm
55555	25 mm Zn
55556	32 mm Zn

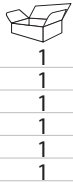

FACSAVAR  
WOOD ŞURUB

NEW

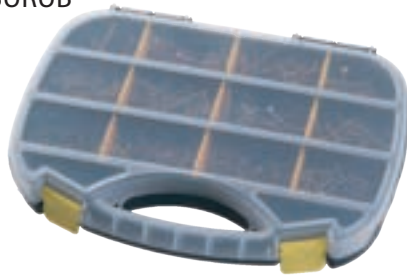

350 - 3,0 x 16 mm
280 - 3,0 x 20 mm
220 - 3,0 x 25 mm
250 - 3,5 x 20 mm
240 - 3,5 x 25 mm
180 - 3,5 x 30 mm
280 - 4,0 x 16 mm
80 - 4,0 x 30 mm
40 - 4,0 x 40 mm
30 - 4,0 x 50 mm
25 - 5,0 x 50 mm
25 - 5,0 x 60 mm

55640 2000 db, bud



ÉPÜLET KÖRMÖK  
CUIE DE CONSTRUCTII



55480	63 mm	1 kg	1	55508	110 mm	5 kg	1
55481	70 mm	1 kg	1	55509	120 mm	5 kg	1
55482	80 mm	1 kg	1	55510	130 mm	5 kg	1
55483	90 mm	1 kg	1	55511	140 mm	5 kg	1
55484	100 mm	1 kg	1	55512	150 mm	5 kg	1
55485	120 mm	1 kg	1	55513	160 mm	5 kg	1
55501	40 mm	5 kg	1	55514	180 mm	5 kg	1
55502	50 mm	5 kg	1	55515	200 mm	5 kg	1
55503	63 mm	5 kg	1	55516	210 mm	5 kg	1
55504	70 mm	5 kg	1	55517	220 mm	5 kg	1
55505	80 mm	5 kg	1	55519	240 mm	5 kg	1
55506	90 mm	5 kg	1	55520	250 mm	5 kg	1
55507	100 mm	5 kg	1	55522	300 mm	5 kg	1

AJTÓKÜSZÖBEINEK  
PRAG UŞA



61270	70 / 7 cm	1
61272	60 / 8 cm	1
61273	70 / 8 cm	1
61274	80 / 8 cm	1
61275	90 / 8 cm	1
61276	60 / 10 cm	1
61277	70 / 10 cm	1
61278	80 / 10 cm	1
61279	90 / 10 cm	1

KÉMÉNYAJTÓ, FÉM  
UŞA DE COŞ DIN TABLĂ



65062



KÉMÉNYAJTÓ, FÉM  
UŞA DE COŞ DIN TABLĂ



65063 szürke/ gri



KÉMÉNYAJTÓ, FÉM  
UŞA DE COŞ DIN TABLĂ



65064 fehér/ alb



KÉMÉNYAJTÓ, FÉM  
UŞA DE COŞ DIN TABLĂ



65065

Zn



**METSZŐOLLÓ  
FOARFECA PENTRU CRENGI**

penge HCS SK-5 - Japán acél  
lame HCS SK-5 - otel japonez

**INOX**



**45020** TW 3152 205mm  
**44980** tartalék rugó/ arc rezerva

**METSZŐOLLÓ  
FOARFECA PENTRU CRENGI**

penge HCS SK-5 - Japán acél  
lame HCS SK-5 - otel japonez

**INOX**



**45023** TW 3152-2 180mm  
**44980** tartalék rugó/ arc rezerva

**METSZŐOLLÓ  
FOARFECA PENTRU CRENGI**

penge HCS SK-5 - Japán acél  
lame HCS SK-5 - otel japonez

**SK5**



**45063** TW 3103A-5 215mm  
**44981** tartalék rugó/ arc rezerva

**METSZŐOLLÓ  
FOARFECA PENTRU CRENGI**

**NEW**



penge HCS SK-5 - Japán acél  
lame HCS SK-5 - otel japonez

**SK5**



**45064** 210 mm Nylon handle  
**44983** tartalék rugó/ arc rezerva

**METSZŐOLLÓ  
FOARFECA PENTRU CRENGI**

penge HCS SK-5 - Japán acél  
lame HCS SK-5 - otel japonez

**SK5**



**45098** 220 mm  
**44983** tartalék rugó/ arc rezerva

**METSZŐOLLÓ  
FOARFECA PENTRU CRENGI**

penge HCS SK-5 - Japán acél  
lame HCS SK-5 - otel japonez

**SK5**



**45099** 190 mm  
**44983** tartalék rugó/ arc rezerva

**METSZŐOLLÓ  
FOARFECA PENTRU CRENGI**

**SK5**

**TEFLON**



**45095** 200 mm  
**44982** tartalék rugó/ arc rezerva

**METSZŐOLLÓ  
FOARFECA PENTRU CRENGI**

**TEFLON**

Forgó markolat/  
maner rotativ



**45096** 220 mm  
**44982** tartalék rugó/ arc rezerva



METSZŐOLLÓ  
FOARFECA PENTRU CRENGI



INOX



45088 160 mm

10

METSZŐOLLÓ  
FOARFECA PENTRU CRENGI



INOX



45089 19,5 mm

10

METSZŐOLLÓ  
FOARFECA PENTRU CRENGI



SK5

TEFLON



penge HCS SK-5 - Japán acél  
lame HCS SK-5 - otel japonez

45097 210 mm

10

44981 tartalék rugó/ arc rezerva

1

TELESZKOPÓS OLLÓ  
FOARFECA PENTRU CRENGI CU MANERTELESCOPIC



45017 150 cm

10

TARTALÉK RUGÓ  
ARC REZERVA



44981 pro nůžky/for pruners 45021, 45025, 45063, 45097 1

44980 pro nůžky/for pruners 45020, 45023 1

44983 pro nůžky/for pruners 45098, 45099 1

44982 pro nůžky/for pruners 45027, 45095, 45096 1

NEW 44984 pro nůžky/for pruners 45110, 45014, 45026 1

PÓT PENGÉK WINLAND  
WINLAND LAMA REZERVA



Ollókhöz  
pentru gradina  
45095, 45096



SK5

TEFLON



45094

20

ÁGVÁGÓ OLLÓ  
FOARFECA LUNGA PENTRU CRENGI, ROTUNJITA



SK5

TEFLON



penge HCS SK-5 - Japán acél  
lame HCS SK-5 - otel japonez

44990 TW 7105, Kapcsolókerékkel / cu clichet

12

ÁGVÁGÓ OLLÓ  
FOARFECA LUNGA PENTRU CRENGI, ROTUNJITA

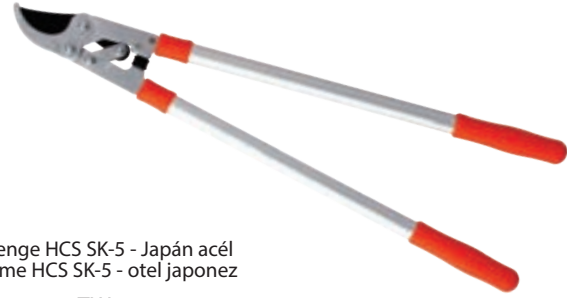

SK5

TEFLON



penge HCS SK-5 - Japán acél  
lame HCS SK-5 - otel japonez

44991 TW 7101

12

ÁGVÁGÓ OLLÓ  
FOARFECA LUNGA PENTRU CRENGI, ROTUNJITA



SK5

TEFLON



penge HCS SK-5 - Japán acél  
lame HCS SK-5 - otel japonez

44992 TW 7105, teleszkópikus / telescopic

10

SÖVÉNYVÁGÓ OLLÓ  
FOARFECA



TEFLON



44996 61 cm, hullámél / ondulat

10

SÖVÉNYVÁGÓ OLLÓ  
FOARFECA

TEFLON



44997 61 cm, egyenes él / drept

10

FŰNYÍRÓ OLLÓ, 360° FORGATHATÓ MARKOLAT  
FOARFECA PENTRU IARBA, INTOARCERE 360°

44998 TW 3159S-1



6

OLLÓ ÉLEZŐ GYÉMÁNTOS 6V1  
ASCUTITOR PENTRU CUȚITE ȘI FOARFECEI 6V1

45068



20

OLLÓ ÉLEZŐ GYÉMÁNTOS  
ASCUTITOR PENTRU CUȚITE ȘI FOARFECEI

45048



20

METSZŐOLLÓ  
FOARFECA

INOX



45010 190 mm

12

44984 Tartalék rugó/ Resort de rezervă

12

METSZŐOLLÓ  
FOARFECA

INOX



45014 190 mm

12

44984 Tartalék rugó/ Resort de rezervă

12

METSZŐOLLÓ  
FOARFECA

INOX



45026 150 mm

12

44984 Tartalék rugó/ Resort de rezervă

12

METSZŐOLLÓ KOVÁCSOLT  
FOARFECA PENTRU CRENGI FORJATA

45018 21 cm



10

METSZŐOLLÓ  
FOARFECA PENTRU CRENGI

TEFLON

SK5



45019 23 cm

10

METSZŐOLLÓ  
FOARFECA PENTRU CRENGI

TEFLON

SK5



45021 21 cm

10

METSZŐOLLÓ  
FOARFECA PENTRU CRENGI

ALU



10

45025 20 cm, Lefékezés /cu blocare

METSZŐOLLÓ  
FOARFECA PENTRU CRENGI

NEW



ALU



10

44970

METSZŐOLLÓ  
FOARFECA PENTRU CRENGI

ALU



10

45027 20 cm, Kapcsolókerékkel /cu clichet

METSZŐOLLÓ  
FOARFECA PENTRU CRENGI

INOX

ALU



10

45029 20 cm

METSZŐOLLÓ  
FOARFECA PENTRU CRENGI

NEW



INOX



10

44971 160 mm

SZÜRETELŐ OLLÓ, EGYENES  
FOARFECA DREAPTA

10

45015 19 cm

SZÜRETELŐ OLLÓ, HAJLÍTOTT  
FOARFECA ROTUNJITA

10

45016 18 cm

VIRÁGOLLÓ, EGYENES  
FOARFECA PENTRU FLORI, DREAPTA

12

45013 16 cm

FŰNYÍRÓ OLLÓ  
FOARFECA PENTRU IARBA

50

45011 30 cm

FŰNYÍRÓ OLLÓ, 180° FORGARHATÓ MARKOLAT  
FOARFECA PENTRU IARBA, INTOARCERE 180°

36

45012 37 cm

▼ ÁGVÁGÓ OLLÓ  
FOARFECA LUNGA PENTRU CRENGI, ROTUNJITA



45000 75 cm



▼ ÁGVÁGÓ OLLÓ  
FOARFECA LUNGA PENTRU CRENGI, ROTUNJITA



45001 71 cm



▼ ÁGVÁGÓ OLLÓ  
FOARFECA LUNGA PENTRU CRENGI, ROTUNJITA



45002 75 cm, Kapcsolókerékkel / cu clichet



▼ ÁGVÁGÓ OLLÓ  
FOARFECA LUNGA PENTRU CRENGI, ROTUNJITA



45003 64-97 cm, teleszkópikus / telescopica



▼ SÖVÉNYVÁGÓ OLLÓ  
FOARFECA



45005 58 cm, beállítható, hullámél 23 cm  
58 cm, tais ajustabil, ondulat 23 cm



▼ SÖVÉNYVÁGÓ OLLÓ  
FOARFECA



45009 51 cm, hullámél / ondulat



▼ SÖVÉNYVÁGÓ OLLÓ  
FOARFECA



45006 58 cm, beállítható, egyenes él 23 cm  
58 cm, tais ajustabil, drept 23 cm



▼ SÖVÉNYVÁGÓ OLLÓ  
FOARFECA



45008 51 cm, egyenes él / drept



▼ SÖVÉNYVÁGÓ OLLÓ  
FOARFECA



45007 23 cm, hullámél, teleszkópikus  
23 cm, ondulat, telescopica



▼ METSZŐOLLÓ TOK  
TOC PENTRU FOARFECI CRENGI



37317



BOZÓTVÁGÓ KÉS  
MACETA

NEW

FESTA®



45069 44 cm



BOZÓTVÁGÓ KÉS  
MACETA



45081 51 cm  
45082 71 cm



BOZÓTVÁGÓ KÉS  
MACETA



45083 43 cm  
45084 60 cm

INOX



KERTI LAPÁT, SZÉLES  
LOPATA LATA



45056 35 cm

INOX



KERTI LAPÁT, KESKENY  
LOPATA INGUSTA



45057 35 cm

INOX



KERTI KAPA EGYENES  
SAPA



45058 27 cm

INOX



GYOMLÁLÓ  
PLIVITOR



45059 38 cm

INOX



KERTI LAPÁT, SZÉLES, MŰANYAG  
LOPATA LATA



45065 28 cm



KERTI LAPÁT, KESKENY, MŰANYAG  
LOPATA INGUSTA



45066 29 cm



KERI VILLA MŰANYAG  
CULTIVATOR



45067 28 cm



KERTI KÉSZLET  
SET UNELTE PENTRU GRADINA



45035 24 cm, 4 db/buc



ÜLTETŐ  
TARUS PENTRU PLANTAT



45037 L 29 cm  
45038 T 28 cm



GYOMLÁLÓ KÉS, EGYENES  
PLIVITOR BURUIENI



45079 20 cm  
45080 20 cm „L”



ÜLTETŐ  
TARUS PENTRU PLANTAT



45087 20 cm



KOPASZTÁS GYOMOK  
JUMULIREA PENTRU WEED



44955 95 cm



GYÜMÖLCSSZEDŐ  
SACULET PENTRU CULES FRUCTE



45041 CZ   
45039 HOBBY  
45034 170-300 cm, teleskop

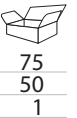

FŰNYÍRÓ DAMIL  
FIR DE TAIAT GAZON

ROSA

Tornado

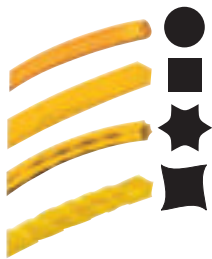

45500	1,3mm x 15m	●	30
45502	1,3mm x 15m	★	30
45503	1,6mm x 15m	●	20
45505	1,6mm x 15m	★	20
45506	2mm x 15m	●	12
45508	2mm x 15m	★	12
45509	2,4mm x 15m	●	12
45511	2,4mm x 15m	★	12
45512	2,4mm x 15m	■	12
45513	3mm x 15m	●	10
45515	3mm x 15m	★	10
45516	3mm x 15m	■	10
45517	2mm x 15m	★	20
45518	2,4mm x 15m	■	20
45519	3mm x 15m	■	10

FŰNYÍRÓ DAMIL  
FIR DE TAIAT GAZON

ROSA

Tornado



45520	2 mm x 162m	●	30
45521	2,4 mm x 112m	●	30
45522	3 mm x 72m	●	20
45525	2 mm x 162m	★	20
45526	2,4 mm x 112m	★	12
45527	3 mm x 72m	★	12

FŰNYÍRÓ DAMIL  
FIR DE TAIAT GAZON

HOBBY

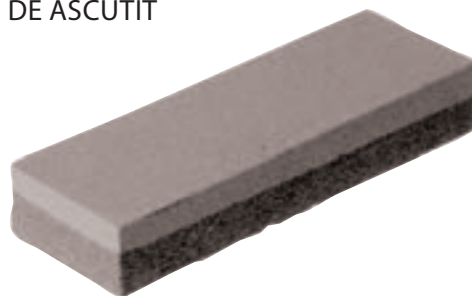

45440	1,3 mm x 15m	●	30
45441	1,6 mm x 15m	●	30
45442	2 mm x 15m	●	20
45443	2,4 mm x 15m	●	20
45444	3 mm x 15m	●	12
45445	1,3 mm x 15m	★	12
45446	1,6 mm x 15m	★	12
45447	2 mm x 15m	★	12
45448	2,4mm x 15m	★	12
45449	3mm x 15m	★	10

FENŐKŐ  
PIATRA DE ASCUTIT

45045 150 x 50 x 30 mm

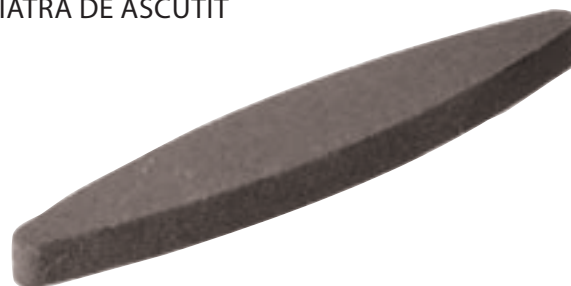

50

FENŐKŐ  
PIATRA DE ASCUTIT

45046 205 X 15 mm



100

KÖTÖZŐDRÓT PVC  
FIRE PE

45477	9m x 10 cm	1
45478	9m x 15 cm	1
45479	9m x 20 cm	1

KÖTÖZŐDRÓT PVC  
FIRE PE

23890	0.4x3x100mm, 100db/buc	1
23891	0.4x3x150mm, 100db/buc	1
23892	0.4x3x200mm, 100db/buc	1
23894	0.4x3x250mm, 100db/buc	1
23895	0.4x3x300mm, 100db/buc	1

KÖTÖZŐDRÓT  
SARMA PENTRU GRADINA

45043 30 m

36

FOGAS RÖGZÍTŐ SZALAG  
CLEME PLASTIC

23840 50 db/buc

1

NÖVÉNYFUTTATÓ DRÓTBÓL  
SPIRALE DE AGATARE PENTRU PLANTE

45044	1,8 m Ø 0,7 cm	komaxit - ezüst/ argint	1
45049	1,8 m Ø 0,7 cm	komaxit - zöld/ verde	1

KERTI FUTTATÓ RÚD, ÜVEGSZÁLAS  
TIJA FIBRA

45036 1,8 m Ø 7,9 mm

200

### MŰANYAG BEVONATÚ KERTI RÚD BAR ACOPERIT PLASTIC



45650	90 cm Ø 8 mm	200	45655	150 cm Ø 11 mm	200	45659	180 cm Ø 16 mm	200
45651	120 cm Ø 8 mm	200	45656	180 cm Ø 11 mm	200	45660	210 cm Ø 16 mm	200
45652	150 cm Ø 8 mm	200	<b>NEW</b> 45661	210 cm Ø 11 mm	200	<b>NEW</b> 45662	150 cm Ø 20 mm	200
45653	90 cm Ø 11 mm	200	45657	120 cm Ø 16 mm	200	<b>NEW</b> 45663	180 cm Ø 20 mm	200
45654	120 cm Ø 11 mm	200	45658	150 cm Ø 16 mm	200	<b>NEW</b> 45664	210 cm Ø 20 mm	200

### CSATLAKOZÓ IDOM, MŰ.A COROBORAT PLASTIC



45670	8 mm	200
45671	11 mm	200
45672	16 mm	200
<b>NEW</b> 45673	20 mm	200

### UBORKAHÁLÓ PLASA PENTRU CASTRAVETI

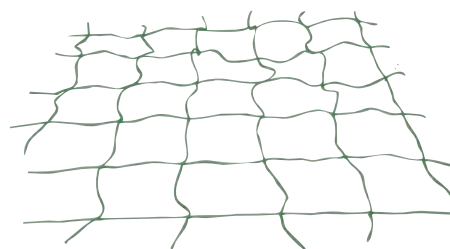

45560	2 m x 10 m	100
-------	------------	-----

### FÁTYOLFÓLIA TESATURA SINTETICA



45550	1,6 x 5 m	50 g/m <sup>2</sup>	40
45551	1,6 x 10 m	50 g/m <sup>2</sup>	20
45552	1,6 x 50 m	50 g/m <sup>2</sup> v roli/roll	1
45553	1,6 x 100 m	50 g/m <sup>2</sup> v roli/roll	1
<b>NEW</b> 45562	3,2 x 50 m	50 g/m <sup>2</sup> v roli/roll	1
<b>NEW</b> 45563	3,2 x 100 m	50 g/m <sup>2</sup> v roli/roll	1

### FÁTYOLFÓLIA TESATURA SINTETICA

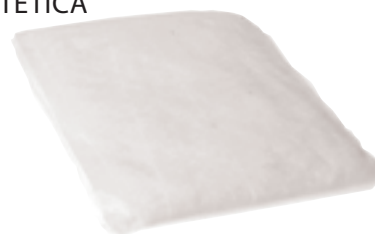

45540	1,6 x 5 m	17 g/m <sup>2</sup>	40
45541	1,6 x 10 m	17 g/m <sup>2</sup>	40
45542	1,6 x 50 m	17 g/m <sup>2</sup> roll	1
45543	1,6 x 100 m	17 g/m <sup>2</sup> roll	1

### FÁTYOLFÓLIA TESATURA SINTETICA

**NEW**



45556	1,6 x 5 m	50 g/m <sup>2</sup>	40
45557	1,6 x 10 m	50 g/m <sup>2</sup>	20
45558	1,6 x 50 m	50 g/m <sup>2</sup> v roli/roll	1
45559	1,6 x 100 m	50 g/m <sup>2</sup> v roli/roll	1

### RÖGZÍTŐ KERTI TAKARÓ SZÖVETEKHEZ ȘTIFT DE ANCORARE PENTRU PRINDEREA TEXTILULUI NEȚESUT



45555	16 cm	10 ks	1
-------	-------	-------	---

### ÖSSZECSUKHATÓ KERTISZÉK, TÉRDEPLŐ SCĂUNEL GRĂDINARIT, PLIANT



45074	1
-------	---

### KERTI TÉRDEPLŐ SUPORT TAIERE

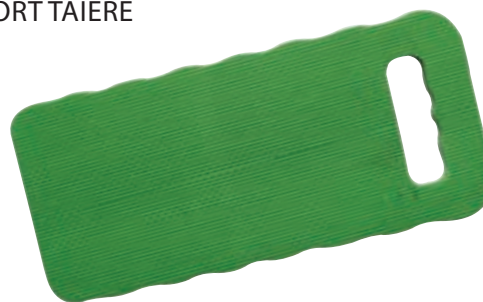

45086	40x18x2cm	45
-------	-----------	----



KOMPOSZTÁLÓ FEKETE  
COMPOSTOR



<b>45700</b>	400 l	1
<b>45701</b>	600 l	1
<b>45702</b>	800 l	1

KOMPOSZTÁLÓ ZÖLD  
COMPOSTOR VERDE



<b>45703</b>	400 l	1
<b>45704</b>	600 l	1
<b>45705</b>	800 l	1

KERTI KOSÁR, ÖSSZECSUKHATÓ  
COS PLIABIL



**45093** 40 x 25 x 23cm

20

LOMBGYÜJTŐ ZSÁK  
SAC COLECTOR

NEW



**44960** 200 l 60 x 60 x 55 cm

20

SZÓRÓ TALIGA  
REMORCA GRADINARIT



**45085** 12 l

2

LOMBGYÜJTŐ ZSÁK  
SAC COLECTOR



**45047** 55 x 70 cm, 3 markolat / manere

20

KULTIVÁTOR, NYELEZHETŐ  
DISCUIȚOR CU TEPI



**45042**

12

▼ PALÁNTÁZÓ  
PLANTATOR CU MANER



INOX



**45040** 23 cm, Automatikával / automat

▼ KERTI GOLYÓS CSAP  
ROBINET CU BILA

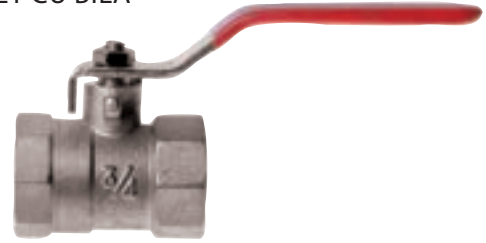

**45106** 1/2"  
**45107** 3/4"  
**45108** 1"

12  
10  
10

▼ FALI CSAP DERÉKSZÖGŰ  
ROBINET COLT



**45104** 1/2" x 3/8"

12

▼ KERTI CSAP  
ROBINET PENTRU GRADINA



**45100** 1/2"  
**45101** 3/4"  
**45102** 1"

12  
12  
6

▼ VIZESKANCSÓ  
CANĂ DE APĂ

NEW



Zn



**45278** 9 l  
**45275** gázelosztóval / barbotare

12  
12

▼ VIZESKANCSÓ  
CANĂ DE APĂ

NEW



**45280** 2 l  
**45283** 6 l  
**45285** 10 l  
**45286** 12 l  
**45287** 14 l

12  
12  
6  
6  
6

LOCSOLÓPISZTOLY  
PISTOL DE STROPIT

ROSA



min. 70kPa  
max. 550kPa



45124 10 funkciós/functii DELUX

12

LOCSOLÓPISZTOLY  
PISTOL DE STROPIT

ROSA



min. 70kPa  
max. 550kPa



45125 10 funkciós/functii DELUX

12

LOCSOLÓPISZTOLY  
PISTOL DE STROPIT

ROSA



min. 70kPa  
max. 550kPa



45126 7 funkciós/functii DELUX

12

LOCSOLÓPISZTOLY  
PISTOL DE STROPIT

ROSA



min. 70kPa  
max. 550kPa



45123 7 funkciós/functii DELUX fém/metal

12

LOCSOLÓPISZTOLY  
PISTOL DE STROPIT

ROSA



min. 70kPa  
max. 550kPa



45117 6 funkciós/functii DELUX

12

LOCSOLÓPISZTOLY  
PISTOL DE STROPIT

ROSA



min. 70kPa  
max. 550kPa



45118 6 funkciós/functii DELUX fém/metal

12

LOCSOLÓPISZTOLY  
PISTOL DE STROPIT

ROSA



min. 70kPa  
max. 550kPa



45110 5 funkciós/functii

12

LOCSOLÓPISZTOLY  
PISTOL DE STROPIT

ROSA



min. 70kPa  
max. 550kPa



45116 Pisztolyrózsa/pistol pulverizator DELUX

12

LOCSOLÓPISZTOLY  
PISTOL DE STROPIT

ROSA



min. 70kPa  
max. 550kPa



45120 fém/metal DELUX

12

LOCSOLÓPISZTOLY  
PISTOL DE STROPIT

ROSA



min. 70kPa  
max. 550kPa



45115 Állítható pisztoly/pistol ajustabil DELUX

12

LOCSOLÓPISZTOLY  
PISTOL DE STROPIT

ROSA



45122 fém/metal



LOCSOLÓPISZTOLY  
PISTOL DE STROPIT

ROSA



min. 70kPa  
max. 550kPa

45111



SUGÁRCSŐ, GYORSCSATLAKOZÓS ÁLLÍ-  
THATÓ  
STROPITOARE

ROSA



min. 70kPa  
max. 550kPa

45113



LOCSOLÓPISZTOLY KÉSZLET SUGÁR  
PISTOL DE STROPIT

ROSA



min. 70kPa  
max. 550kPa

45114 Állítható pisztoly + Gyorscsatlakozó 1/2"  
pistol ajustabil + Conector 1/2"



SUGÁRCSŐ, RÁHÚZHATÓ TÖMLŐ  
CSATLAKOZÓVAL  
STROPITOARE CU PRINDERE CLASICA

ROSA



45112 sugárcső, klaszikus csatlakozással/  
aerodinamic, conexiune clasica



LOCSOLÓPISZTOLY KÉSZLET  
SET PISTOL DE STROPIT

ROSA



min. 70kPa  
max. 550kPa

45181 6 funkciós / functii



SUGÁRCSŐ KÉSZLET, 4 DB-OS  
SET CU PISTOL DE STROPIT

ROSA



1030kPa

45180 1/2"



KÉTUTAS CSATLAKOZÓ  
RACORD BIFURCAT PENTRU 2 CUPLE  
RAPIDE

ROSA



690kPa

45134 Elosztó szeleppel, 2 gyorscsatlakozó/  
adaptor cu robinet, conector pentru 2 furturnuri



CSAPCSATLAKOZÓ, BELSŐMENETES  
CONECTOR CU ROBINET

ROSA



690kPa

45135 Egyszerű csatlakozódugó Szeleppel/  
conector simplu cu robinet



TÖMLŐ ÖSSZEKÖTŐ  
RACORD

ROSA



1030kPa

45140 1/2"

45296 1/2", 20 db/buc



1

▼ TÖMLŐ ÖSSZEKÖTŐ  
RACORD



ROSA



45141 3/4"  
45297 3/4", 20 db/buc

60  
1

▼ GYORSCSATLAKOZÓ  
CONECTOR



ROSA



45142 1/2"  
45298 1/2", 20 db/buc

60  
1

▼ GYORSCSATLAKOZÓ  
CONECTOR



ROSA



45143 3/4"  
45299 3/4", 20 db/buc

60  
1

▼ GYORSCSATLAKOZÓ, STOPPAL  
CONECTOR CU STOP



ROSA



45138 1/2"  
45294 1/2", 20db/buc

60  
1

▼ GYORSCSATLAKOZÓ, STOPPAL  
CONECTOR CU STOP



ROSA



45139 3/4"  
45295 3/4", 20 db/buc

60  
1

▼ CSAPCSATLAKOZÓ, BELSŐMENETES  
ADAPTOR CU FILET INTERIOR



ROSA



45130 belsőmenetes 1/2"+3/4" cu filet interior 60  
45289 belsőmenetes 1/2"+3/4" cu filet interior 20db/buc 1  
45131 belsőmenetes 3/4"+1" cu filet interior 60  
45290 belsőmenetes 3/4"+1" cu filet interior 20db/buc 1

▼ SZŰKÍTŐ  
REDUCTOR FURTUN



ROSA



45213 1/2" - 3/4"

60

▼ CSATLAKOZÓ KÉSZLET  
SET CONECTORI PENTRU FURTUN



ROSA



45144 2 ks csapcsatlakozó/adaptor + Gyorscsatlakozó /conector 3/4"

60  
1

▼ CSAPCSATLAKOZÓ, BILINCCSEL  
ADAPTOR PENTRU FURTUN



ROSA



45145 1/2"-os tömlőkapocs / cu colier de prindere

60

▼ „Y” ELÁGAZÓ  
ADAPTOR PENTRU  
3 FURTUNURI



ROSA



45137 háromutas elosztó/  
adaptor cu 3 conectori

60

CSAPCSATLAKOZÓ, KÜLSŐMENETES  
ADAPTOR CU FILET EXTERIOR

ROSA



45133	külsőmenetes 3/4" / cu filet exterior	60
45292	külsőmenetes 3/4" / cu filet exterior 20ks/pcs	1

CSAPCSATLAKOZÓ, BELSŐMENETES  
ADAPTOR CU FILET INTERIOR

ROSA



45132	belsőmenetes 3/4" / cu filet interior	60
45291	belsőmenetes 3/4" / cu filet interior 20ks/pcs	1

IDŐZÍTŐ  
TEMPORIZATOR APA

ROSA



45147	0-2 h.	24
-------	--------	----

LOCSOLÓ, PULZÁLÓ, MŰANYAG, MENETES  
STROPITOARE, IMPULS

ROSA

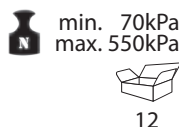

45151	min. 70kPa max. 550kPa	12
-------	---------------------------	----

LOCSOLÓ, PULZÁLÓ, MŰANYAG, LESZÚR-  
HATÓ  
STROPITOARE, IMPULS TARUS, 1 SENS, PLAS-

ROSA



45161		20
-------	--	----

KUPLUNG CSATLAKOZÓ  
ADAPTOR PENTRU 2 FURTUNURI

ROSA



45136	2-utas elosztó/ adaptor cu 2 conectori	60
45293	2-utas elosztó 20 db adaptor cu 2 conectori 20 buc	1

KÍNÁLÓ KÉSZLET  
CUTIE PREZENTARE

ROSA

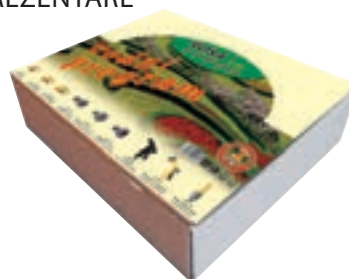

készlet tartalma/set:  
45113 15 db/buc  
45117 10 db/buc  
45120 15 db/buc  
45132 40 db/buc  
45131 40 db/buc  
45133 40 db/buc  
45142 25 db/buc  
45143 20 db/buc  
45140 20 db/buc



45146		1
-------	--	---

LOCSOLÓ, PULZÁLÓ, RÉZ, MENETES  
STROPITOARE, IMPULS

ROSA

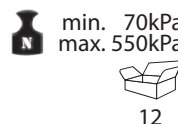

45150	réz/alama min. 70kPa max. 550kPa	12
-------	--	----

LOCSOLÓ, LESZÚRHAJTÓ, PULZÁLÓ  
STROPITOARE 2 FURTUNURI

ROSA



45168	Műanyag / plastic	12
45169	fém / metal	12

LOCSOLÓ, 3 FORGÓVAL, LESZÚRHAJTÓ  
STROPITOARE TARUS 3 SENSURI, PLAS-  
TIC

ROSA



45164	min. 70kPa max. 550kPa	12
-------	---------------------------	----

LOCSOLÓ, 2 FORGÓVAL  
STROPITOARE ROTATIVA 2 SENSURI

ROSA



min. 70kPa  
max. 550kPa



45153

24

LOCSOLÓ, 3 FORGÓVAL  
STROPITOARE ROTATIVA 3 SENSURI

ROSA



min. 70kPa  
max. 550kPa



45152

24

PULZÁLÓ LOCSOLÓTALP, PROFI  
STROPITOARE, IMPULS PROFI

ROSA



min. 70kPa  
max. 550kPa



45162

24

LOCSOLÓTALP 8 FUNKCIÓS  
STROPITOARE 8 FUNCTII

ROSA



min. 70kPa  
max. 550kPa



45154

48

BILLENŐ LOCSOLÓ, MŰANYAG  
STROPITOARE CU BALANSARE

ROSA



ALU



45158 17 lyukas/jeturi ALU

6

LOCSOLÓPIRAMIS  
STROPITOARE PIRAMIDALA

ROSA



45167

12

LOCSOLÓ, ESŐZTETŐ, LESZHÚRHATÓ  
STROPITOARE TARUS

ROSA



45160

25

LOCSOLÓTALP  
STROPITOARE PLATA CU ROBINET

ROSA



45156 cserép locsoló / stropitoare plata cu robinet

12

LOCSOLÓTALP  
STAND BAZA H PENTRU STROPITOARE IMPULS

ROSA



45155 talp szakaszos locsolókhöz/  
Suport pentru stropitoare rotativa

24

LOCSOLÓ, PULZÁLÓ,  
ÁLLVÁNYOS  
STROPITOARE IMPULS,  
STAND

ROSA



45163

20

LESZÚRÓ FÉM  
SUPPORT TIP TARUS

ROSA



Zn



12

45159 Horganyzott / zincat

TÖMLŐVEZETŐ  
SUPPORT FIXARE FURTUN

ROSA



48

45186

LESZÚRÓ MŰANYAG  
SUPPORT TARUS

ROSA



12

45179

SZAKASZOS LOCSOLÓ, FÉM  
STROPITOARE ROTATIVA

ROSA



20

45185 1"

SZAKASZOS LOCSOLÓ, FÉM  
STROPITOARE ROTATIVA

ROSA



30

45184 3/4"

KERTI ZUHANYZÓ, LESZÚRHTÓ  
DUS GRADINA REGLABIL

ROSA



12

45171

KERTI ZUHANYZÓ, 3 LÁBAS  
DUS 3 BRATE

ROSA



min. 70kPa  
max. 550kPa



6

45170

LOCSOLÓ FEJ, HOSSZABBÍTÓ  
DUS GRADINA  
MANUAL

ROSA



min. 70kPa  
max. 550kPa



12

45172 záróval/cu robinet

45173 10 funkciós/functii

12

12



„O” GYŰRŰ KÉSZLET  
SET GARNITURI

ROSA



Tételekhez /pentru articolele:  
45110, 45111, 45118, 45120,  
45121, 45123, 45125, 45126,  
45130, 45131, 45132, 45134,  
45135, 45152, 45153, 45154,  
45155, 45156, 45162, 45177,  
45178, 45180, 45196, 45197,  
45198



45175

„O” GYŰRŰ  
GARNITURA CAUCIUC



45187 50db/buc

TÖMLŐTARTÓ  
SUPPORT FURTUN

ROSA



45174

TÖMLŐTARTÓ DOB  
FURTUN GRADINA AUTOINFASURARE

ROSA



min. 70kPa  
max. 550kPa



45176 1/2" 20 m

TÖMLŐTARTÓ FALRA SZERELHETŐ  
FURTUN GRADINA AUTOINFASURARE

ROSA



45182 1/2" 40 m

TÖMLŐTARTÓ KOCSI, MŰANYAG  
CARUCIOR CU FURTUN GRADINA



45183 1/2" 60m

TÖMLŐTARTÓ KOCSI  
MŰANYAG  
CARUCIOR CU FURTUN  
GRADINA

ROSA



45177 1/2" 60 m

TÖMLŐTARTÓ, TALPAS  
FURTUN GRADINA PE ROLA

ROSA



45178 1/2" 60 m

SPIRÁL TÖMLŐ  
FURTUN SPIRALAT

ROSA



min. 70kPa  
max. 550kPa



45300 7,5 m  
45301 15 m

KERTI TÖMLŐ  
FURTUN DE GRĂDINĂ



45353	1"	25m	transparent	1
45366	1"	25m	non transparent	1
45345	1/2"	25m	transparent	1
45360	1/2"	25m	non transparent	1
45349	3/4"	25m	transparent	1
45364	3/4"	25m	non transparent	1

GYORSCSATLAKOZÓ, STOPPAL  
CONECTOR CU STOP

ROSA



min. 70kPa  
max.1380kPa



45190 1/2"

TÖMLŐ ÖSSZEKÖTŐ  
RACORD FURTUN

ROSA



min. 70kPa  
max.1380kPa



45192 1/2"

GYORSCSATLAKOZÓ, STOPPAL  
CONECTOR CU STOP

ROSA



min. 70kPa  
max.1380kPa



45191 3/4"

GYORSCSATLAKOZÓ  
CONECTOR

ROSA



min. 70kPa  
max.1380kPa



45194 1/2"

GYORSCSATLAKOZÓ  
CONECTOR

ROSA



min. 70kPa  
max.1380kPa



45195 3/4"

TÖMLŐ ÖSSZEKÖTŐ  
RACORD FURTUN

ROSA



min. 70kPa  
max.1380kPa



45193 3/4"

CSAPCSATLAKOZÓ, BELSŐMENETES  
ADAPTOR CU FILET INTERIOR

ROSA



min. 70kPa  
max.1380kPa



45197 3/4"

CSAPCSATLAKOZÓ, BELSŐMENETES  
ADAPTOR CU FILET INTERIOR

ROSA



min. 70kPa  
max.1380kPa



45196 1/2"+3/4"

CSAPCSATLAKOZÓ, BELSŐMENETES  
ADAPTOR CU FILET INTERIOR

ROSA



min. 70kPa  
max.1380kPa



45199 1"

CSAPCSATLAKOZÓ, BELSŐMENETES  
ADAPTOR CU FILET INTERIOR

ROSA



min. 70kPa  
max.1380kPa



45198 3/4"+1"

CSAPCSATLAKOZÓ, KULSŐMENETES  
ADAPTOR CU FILET EXTERIOR

ROSA



min. 70kPa  
max.1380kPa



45200 3/4"

1

„Y” ELÁGAZÓ  
ADAPTOR

ROSA



min. 70kPa  
max.1380kPa

45204 háromutas elosztó/  
adaptor cu 3 conectori

1

SUGÁRCSŐ GYORSCSATLAKOZÓS, ÁLLÍTHATÓ  
DUZA DE STROPIRE REGLABILA

ROSA

NEW



1030kPa



45214 1"

1

SZŰKÍTŐ  
REDUCTOR FURTUN

ROSA

NEW



1030kPa



45216 3/4" - 1"

1

TÖMLŐ ÖSSZEKÖTŐ  
RACORD FURTUN

ROSA

NEW



1030kPa



45218 1"

1

KUPLUNG CSATLAKOZÓ  
ADAPTOR

ROSA



min. 70kPa  
max.1380kPa

45203 2-utas elosztó/  
adaptor cu 2 conectori

1

SUGÁRCSŐ GYORSCSATLAKOZÓS, ÁLLÍTHATÓ  
DUZA DE STROPIRE REGLABILA

ROSA



min. 70kPa  
max.1380kPa



45206 Állítható / ajustabil

1

CSAPCSATLAKOZÓ, BELSŐMENETES  
ADAPTOR CU FILET INTERIOR

ROSA

NEW



1030kPa



45215 1"

1

CSAPCSATLAKOZÓ, BELSŐMENETES  
ADAPTOR CU FILET INTERIOR

ROSA

NEW



1030kPa



45217 3/4" + 1"

1

GYORSCSATLAKOZÓ  
CONECTOR

ROSA

NEW



1030kPa



45219 1"

1

SUGÁRCSŐ, CSAPOS STROPITOARE



45210 1"



10

TÖMLŐ ÖSSZEKÖTŐ, CSAPOS RACORD FURTUN



45212 1", závit 1"



10

TÖMLŐ ÖSSZEKÖTŐ, CSAPOS RACORD FURTUN



45211 1", závit 1"



25

TÖMLŐ ÖSSZEKÖTŐ, CSAPOS RACORD FURTUN



45220 1/2"  
45221 3/4"  
45222 1"



10  
10  
10

CSAPCSATLAKOZÓ, CSAPOS RACORD CU OLANDEZA



45223 1/2"  
45224 3/4"  
45225 1"



10  
10  
10

SZÜKÍTŐ, CSAPOS REDUCTOR



45226 1/2" - 3/4"  
45227 1" - 3/4"  
45228 1" - 1/2"



10  
10  
10

SUGÁRCSŐ, CSAPOS STROPITOARE



45229 1/2" - 3/4"



10

TÖMLŐ BILINCS COLIERE



Zn



45600	8 - 12 mm	100
45601	10 - 16 mm	100
45602	12 - 20 mm	100
45603	16 - 25 mm	100
45604	20 - 32 mm	100
45605	25 - 40 mm	100
45606	30 - 45 mm	100
45607	32 - 50 mm	100
45608	40 - 60 mm	100
45609	50 - 70 mm	100
45610	60 - 80 mm	50
45611	70 - 90 mm	50
45612	80 - 100 mm	50
45613	90 - 110 mm	50
45614	100 - 120 mm	50
45615	110 - 130 mm	50
45616	120 - 140 mm	50
45617	130 - 150 mm	50
45618	140 - 160 mm	50
45619	150 - 170 mm	50

TÖMLŐ BILINCS ROZSDAMENTES INOX COLIERE



INOX



45620	8 - 12 mm - 9 mm	100
45621	10 - 16 mm - 9 mm	100
45622	12 - 20 mm - 9 mm	100
45623	16 - 25 mm - 9 mm	100
45624	20 - 32 mm - 9 mm	100
45625	25 - 40 mm - 12 mm	100
45626	30 - 45 mm - 12 mm	100
45627	32 - 50 mm - 12 mm	100
45628	40 - 60 mm - 12 mm	100
45629	50 - 70 mm - 12 mm	100
45630	60 - 80 mm - 12 mm	100
45631	70 - 90 mm - 12 mm	100
45632	80 - 100 mm - 12 mm	50
45633	90 - 110 mm - 12 mm	50
45634	100 - 120 mm - 12 mm	50
45635	110 - 130 mm - 12 mm	50
45636	120 - 140 mm - 12 mm	50
45637	130 - 150 mm - 12 mm	50
45638	140 - 160 mm - 12 mm	50
45639	150 - 170 mm - 12 mm	50

▼ KÉZI PERMETEZŐ  
PULVERIZATOR DE PRESIUNE



45245	5 l		1
45246	8 l		1

45250	Rezervni motka		1
45253	Tartalék pótfúvórka		1
45256	Tartalék fogantyú		1
45260	Tartalék bot - 370mm		1

▼ KÉZI PERMETEZŐ  
PULVERIZATOR DE PRESIUNE



45247	12 l		1
45248	16 l		1

45251	Rezervni motka		1
45254	Tartalék pótfúvórka		1
45257	Tartalék fogantyú		1
45261	Tartalék bot - 370mm		1

▼ KÉZI PERMETEZŐ  
PULVERIZATOR DE PRESIUNE



45240	0,7 l		1
45241	2 l		1

▼ GYOMÍRTÓ HARANG  
HERBICID BELL



45265	kicsi/ mic	d 230 x š 90 x v 130 mm		1
45266	nagy/ mare	d 370 x š 140 x v 200 mm		1

GEREBLYE  
GREBLA

NEW

FESTA®



44965 Teleskopic



GEREBLYE  
GREBLA



45050 1200 g Adjustable, Zn coated



GEREBLYE 45 CM  
GREBLA 45 CM



45051 45 cm Lamel



MEGLÁTJUK FA NYÉLLEL 160 CM  
RAKE CU MÄNER DIN LEMN 160 CM

NEW



61130 45 cm Lamel



GEREBLYE 45 CM  
GREBLA 45 CM



45052 45 cm huzal



MEGLÁTJUK FA NYÉLLEL 160 CM  
RAKE CU MÄNER DIN LEMN 160 CM

NEW



61131 45 cm huzal



GEREBLYE  
GREBLA

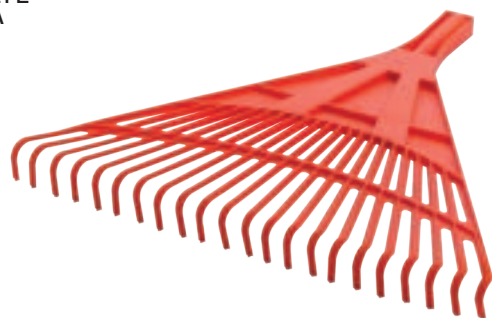

45320 60 cm 24 lamel



MEGLÁTJUK FA NYÉLLEL 160 CM  
RAKE CU MÄNER DIN LEMN 160 CM

NEW



61132 60 cm 24 lamel



GEREBLYE  
GREBLA

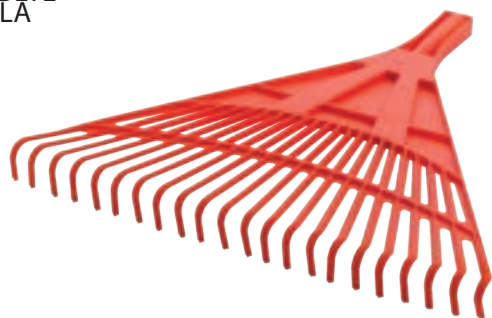

45055 50 cm 22 lamel



MEGLÁTJUK FA NYÉLLEL 160 CM  
RAKE CU MÄNER DIN LEMN 160 CM

NEW



61133 50 cm 22 lamel



GEREBLYE  
GREBLA



45321 23 lamel

GEREBLYE  
GREBLA



45054 23 lamel

GEREBLYE  
GREBLA

NEW



45327 13 lamel 240 x 200 mm

GEREBLYE  
GREBLA

NEW



45328 23 lamel 480 x 280 mm

GEREBLYE  
GREBLA

NEW



45329 35 lamel 760 x 310 mm

MEGLÁTJUK FA NYÉLLEL 160 CM  
RAKE CU MÄNER DIN LEMN 160 CM



NEW



61134 23 lamel

MEGLÁTJUK FA NYÉLLEL 160 CM  
RAKE CU MÄNER DIN LEMN 160 CM



NEW



61135 23 lamel

MEGLÁTJUK FA NYÉLLEL  
RAKE CU MÄNER DIN LEMN

NEW



system click  
ON-OFF



61136 160 cm násada / handle, 13 lamel / lamellas  
61147 100 cm násada / handle, 13 lamel / lamellas

MEGLÁTJUK FA NYÉLLEL  
RAKE CU MÄNER DIN LEMN

NEW



system click  
ON-OFF



61137 160 cm handle, 23 Lamel  
61148 100 cm handle, 23 Lamel

MEGLÁTJUK FA NYÉLLEL  
RAKE CU MÄNER DIN LEMN

NEW



system click  
ON-OFF



61138 35 lamel

GEREBLYE  
GREBLA

NEW



45325 12 lamel / lamellas 410 mm



MEGLÁTJUK FA NYÉLLEL  
RAKE CU MÄNER DIN LEMN

NEW



sistem click  
ON-OFF

61139 12 lamel / lamellas



GEREBLYE  
GREBLA

NEW



45326 18 lamel / lamellas 580 mm



MEGLÁTJUK FA NYÉLLEL  
RAKE CU MÄNER DIN LEMN

NEW



sistem click  
ON-OFF

61140 18 lamel / lamellas



GEREBLYE  
GREBLA



45053 16 tú / bolt



MEGLÁTJUK FA NYÉLLEL 160 CM  
RAKE CU MÄNER DIN LEMN 160 CM

NEW



61141 16 tú / bolt



GEREBLYE  
GREBLA



45070 14 fogak/danturä



MEGLÁTJUK FA NYÉLLEL 160 CM  
RAKE CU MÄNER DIN LEMN 160 CM

NEW



61142 14 fogak/danturä



GEREBLYE  
GREBLA



61045 12 fogak/danturä



61046 14 fogak/danturä

25

61047 16 fogak/danturä

25

MEGLÁTJUK FA NYÉLLEL 160 CM  
RAKE CU MÄNER DIN LEMN 160 CM

NEW



61143 12 fogak/danturä



61144 14 fogak/danturä

25

61145 16 fogak/danturä

25



GEREBLYE  
GREBLA



<b>61030</b>	10 fogak/dantură	24
<b>61031</b>	12 fogak/dantură	24
<b>61032</b>	14 fogak/dantură	24
<b>61033</b>	16 fogak/dantură	24

GEREBLYE  
GREBLA



**61048** 11 / 21 fogak/dantură

1

GEREBLYE  
GREBLA

NEW



<b>61212</b>	Násada na hrabě / Handle	1
<b>61213</b>	Hřeben na hrabě PVC kolík / Head for wooden rakes	1
<b>61214</b>	PVC kolík / PVC pin	1

GEREBLYE  
GREBLA

NEW



<b>61212</b>	Handle	1
<b>61210</b>	Head for wooden rakes	1

MEGLÁTJUK FA NYÉLLEL 160 CM  
RAKE CU MÄNER DIN LEMN160 CM

FESTA®



**61034** 14 fogak/dantură handle fiberglass

1

MEGLÁTJUK FA NYÉLLEL 160 CM  
RAKE CU MÄNER DIN LEMN160 CM

FESTA®

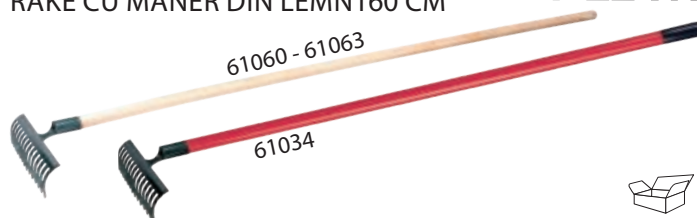

<b>61060</b>	10 fogak/dantură	wooden handle	1
<b>61061</b>	12 fogak/dantură	wooden handle	1
<b>61062</b>	14 fogak/dantură	wooden handle	1
<b>61063</b>	16 fogak/dantură	wooden handle	1
<b>61034</b>	14 fogak/dantură	handle fiberglass	1

MEGLÁTJUK FA NYÉLLEL 160 CM  
RAKE CU MÄNER DIN LEMN160 CM

NEW



**61146** 11 / 21 fogak/dantură

1

MEGLÁTJUK FA NYÉLLEL 160 CM  
RAKE CU MÄNER DIN LEMN160 CM

NEW



**61211**

1

MEGLÁTJUK FA NYÉLLEL 160 CM  
RAKE CU MÄNER DIN LEMN160 CM

NEW



**61216**

1

ASÓ  
CAZMA

FESTA®



61005 20 x 29 cm, fém nyéllel / Fe maner 100 cm



1

ASÓ  
CAZMA

FESTA®



61006 19 x 28 cm, fém nyéllel / Fe maner 100 cm



1

ÁSÓ - BŐVÍTETT FOGANTYÚ

FESTA®

NEW

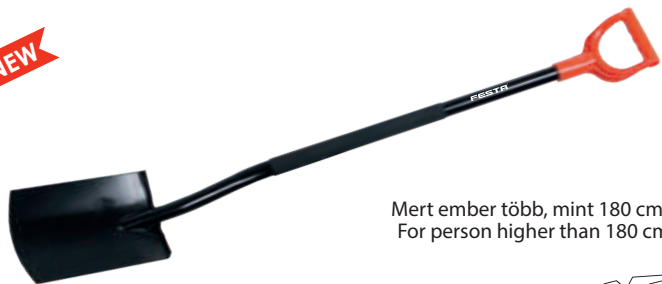

Mert ember több, mint 180 cm -  
For person higher than 180 cm

61157 20 x 29 cm, fém nyéllel / Fe maner 130 cm



1

ÁSÓ - BŐVÍTETT FOGANTYÚ

FESTA®

NEW



Mert ember több, mint 180 cm -  
For person higher than 180 cm

61158 19 x 28 cm, fém nyéllel / Fe maner 130 cm



12

LAPÁT  
LOPATA

FESTA®

NEW



61155 24 x 29 cm, fém nyéllel / Fe maner 120 cm



1

VASVILLA ÜVEGSZÁLAS NYÉLLEL  
FURCA

FESTA®

NEW



61156 fém nyéllel / Fe maner 130 cm



12

VASVILLA  
FURCA

FESTA®



61007 18 x 28 cm, fém nyéllel / Fe maner 95 cm



1

ÁSÓ ÜVEGSZÁLAS NYÉLLEL  
CAZMA FIBERGLASS



61015 19 x 30 cm, nyéllel / maner 95 cm - fiberglass



12

ÁSÓ HEGYES ÜVEGSZÁLAS NYÉLLEL  
CAZMA FIBERGLASS



61029 19 x 30 cm, nyéllel / maner 95 cm - fiberglass



12

VASVILLA ÜVEGSZÁLAS NYÉLLEL  
FURCA

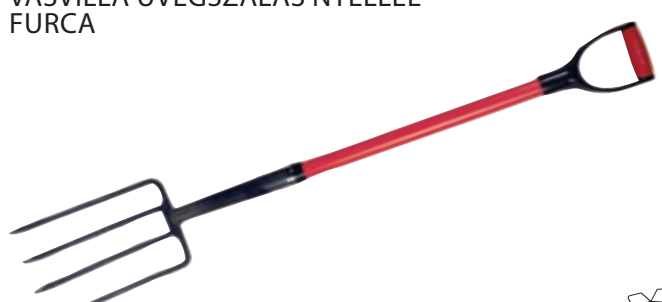

61010 18 x 30 cm, nyéllel / maner 95 cm - fiberglass



12

▼ ÁSÓLAPÁT  
LOPATA ROTUNDA



kalapácslakk/  
cu vopsea de ciocan



**61000** 26 x 28 cm, nyél nélkül/fara coada

12

▼ ÁSÓLAPÁT  
LOPATA ROTUNDA



fa nyéllel /  
coada lemn cu cot



**61050** 26 x 28 cm

1

▼ ÁSÓLAPÁT  
LOPATA



**61020** 24 x 28 cm, nyél nélkül/fara coada

12

▼ ÁSÓLAPÁT  
LOPATA ROTUNDA



fa nyéllel /  
coada lemn cu cot



**61088** 26 x 28 cm

1

▼ LAPÁT STANDARD  
LOPATA



kalapácslakk/  
cu vopsea de ciocan



**61001** 24 x 29 cm, nyél nélkül/fara coada

12

▼ LAPÁT STANDARD  
LOPATA



fa nyéllel /  
coada lemn cu cot



**61051** 24 x 29 cm

5

▼ LAPÁT STANDARD  
LOPATA



**61022** 24 x 29 cm, nyél nélkül/fara coada

12

▼ LAPÁT STANDARD  
LOPATA



**61090** 24 x 29 cm

5

**61053** 24 x 29 cm násada/ handle, "T"

5

▼ LAPÁT  
LOPATA



**61023** 27 x 28 cm

5

**61021** 35 x 35 cm

5



fa nyéllel /  
coada lemn cu cot



**61087** 27 x 28 cm

5

**61089** 35 x 35 cm

5

LAPÁT ALU  
LOPATA



ALU



61025 34x30 cm, nyél nélkül/fara coada  
61026 26x29 cm, nyél nélkül/fara coada

10  
10

LAPÁT  
LOPATA



ALU

fa nyéllel /  
coada lemn cu cot



61056 34 x 30 cm  
61057 26 x 29 cm

1

LAPÁT  
LOPATA



61043 26 x 28 cm

1

LAPÁT  
LOPATA



61027 24 x 28 cm, „T” 60 cm  
61091 26 x 28 cm, „T” 130 cm

1  
1

LAPÁT KESKENY  
LOPATA INGUSTA



FESTA®

kalapácslakk/  
cu vopsea de ciocan



61002 19 x 27 cm, nyél nélkül/fara coada

12

LAPÁT KESKENY  
LOPATA INGUSTA



FESTA®



61052 19 x 27 cm

12

LAPÁT KESKENY  
LOPATA



FESTA®



61024 19 x 27 cm, nyél nélkül/fara coada

12

LAPÁT  
LOPATA INGUSTA



FESTA®

fa nyéllel /  
coada lemn cu cot



61054 19 x 27 cm

5

ÁSÓ FEKETE HEGYES  
CAZMA



FESTA®

kalapácslakk/  
cu vopsea de ciocan



61004 22 x 30 cm, nyél nélkül/fara coada

12

ÁSÓ FEKETE HEGYES  
CAZMA



FESTA®

NEW



61161 22 x 30 cm

12

▼ **ÁSÓ FEKETE HEGYES  
CAZMA**

**FESTA®****61019** 22 x 30 cm, nyél nélkül/fara coada

12

▼ **KOVÁCSOLT ÁSÓ HEGYES  
CAZMA FIER FORJAT**

**61013** 22 x 25 cm, nyél nélkül/fara coada

1

▼ **ÁSÓ FEKETE ÍVES  
CAZMA**

**FESTA®**kalapácslakk/  
cu vopsea de ciocan**61003** 21 x 30 cm, nyél nélkül/fara coada

12

▼ **ÁSÓ FEKETE ÍVES  
CAZMA**

**FESTA®****61018** 21 x 30 cm, nyél nélkül/fara coada

12

▼ **ÁSÓ  
CAZMA**

**61014** 14 x 37 cm, nyél nélkül/fara coada

12

▼ **ÁSÓ HEGYES FA NYÉLLEL  
CAZMA**

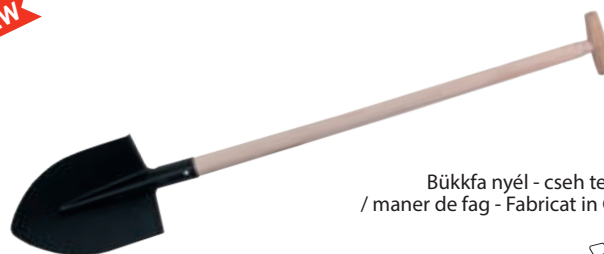
**FESTA®****NEW**Bükkfa nyél - cseh termék  
/ maner de fag - Fabricat in Cehia**61097** 19x30cm - fa nyéllel / maner din fag in „T” 90cm

12

▼ **KOVÁCSOLT ÁSÓ HEGYES  
CAZMA FIER FORJAT**

**NEW****61162** 22 x 25 cm

1

▼ **ÁSÓ FEKETE ÍVES  
CAZMA**

**FESTA®****NEW****61163** 21 x 30 cm

12

▼ **ÁSÓ FA NYÉLLEL  
CASMA**

**FESTA®**Bükkfa nyél - cseh termék  
/ maner de fag - Fabricat in Cehia**61098** 19x30cm - fa nyéllel / maner din fag in „T” 90cm

12

▼ **ÁSÓ  
CAZMA**

**NEW****61164** 14 x 37 cm

12

VILLA  
FURCA



61009 nyél nélkül/fara coada



VILLA  
FURCA

NEW



61165



KOVÁCSOLT ÁSÓVILLA  
FURCA



61012 nyél nélkül/fara coada



KOVÁCSOLT ÁSÓVILLA  
FURCA

NEW



61166



VILLA  
FURCA



61044 nyél nélkül/fara coada



VASVILLA FA NYÉLLEL  
FURCA

NEW

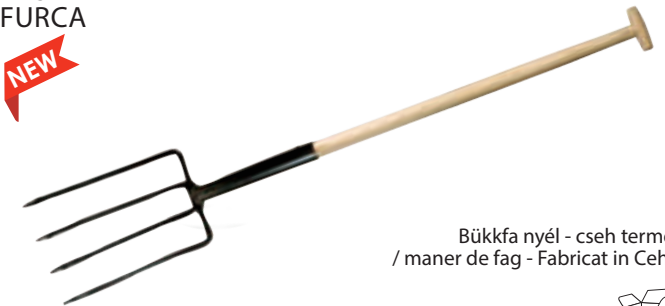

Bükkfa nyél - cseh termék  
/ maner de fag - Fabricat in Cehia

61028 18 x 30 cm, fa nyéllel / maner din fag in „T” 90cm



KAPA HEGYES  
SAPA ASCUTITA



61035 0,4 kg  
61036 0,6 kg  
61037 0,7 kg



KAPA HEGYES  
SAPA ASCUTITA

NEW

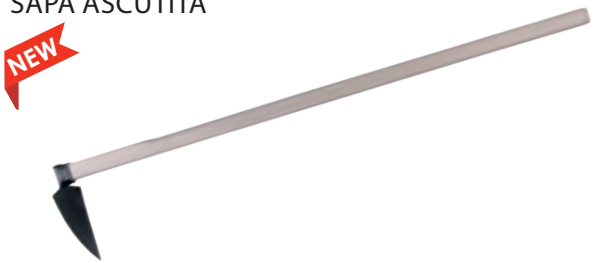

61111 0,4 kg  
61112 0,6 kg  
61113 0,7 kg



RÉPAKAPA  
SAPA FORJATA PLATA



61038 0,6 kg



RÉPAKAPA  
SAPA FORJATA PLATA

NEW

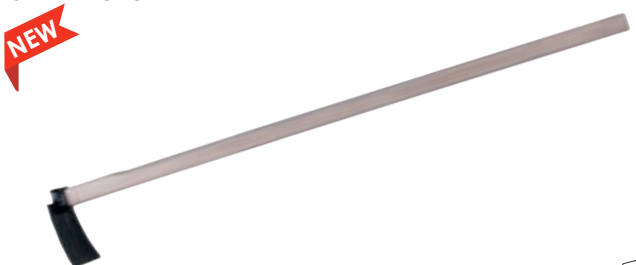

61114 0,6 kg



HOROLÓKAPA  
SAPA FORJATA PLATA

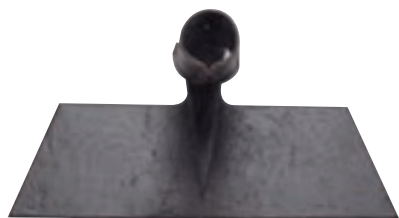

61039 0,7 kg



1

HOROLÓKAPA  
SAPA FORJATA PLATA

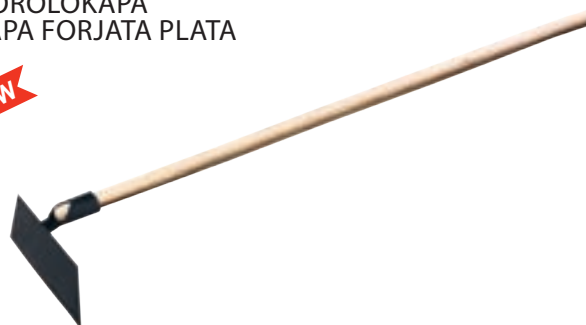

61168 0,7 kg



1

BETON TÖMÖRÍTŐ, NYÉL NÉLKÜL  
SCULA PENTRU BETON



60100



24

BETON TÖMÖRÍTŐ, NYÉL NÉLKÜL  
SCULA PENTRU BETON



61169



24

KAPA  
SAPA



61083 800 g



6

KAPA  
SAPA



61084



6

KAPA  
SAPA



61067 75 mm  
61068 125 mm  
61069 175 mm



6

6

6

KAPA  
SAPA



61290 75 mm  
61291 125 mm  
61292 175 mm



6

6

6

KAPA  
SAPA



61070 140 mm



6

KAPA  
SAPA



61293 140 mm



6

KAPA  
SAPA

NEW



61294 140 mm



6

KAPA  
SAPA

NEW



61295



6

KAPA  
SAPA

NEW



61296 175 mm



6

KAPA  
SAPA

NEW

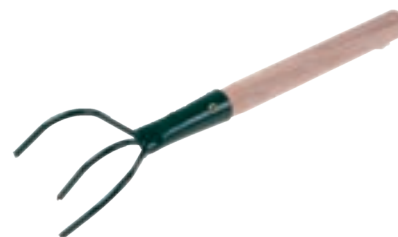

61297



6

CSÁKÁNY  
TARNACOP



NEW 61120 1,5 kg  
61040 2,5 kg



6

1

CSÁKÁNY  
TARNACOP



NEW 61121 1,5 kg  
61042 2,5 kg



6

1

CSÁKÁNY FIBERGLASS  
TARNACOP FIBERGLASS

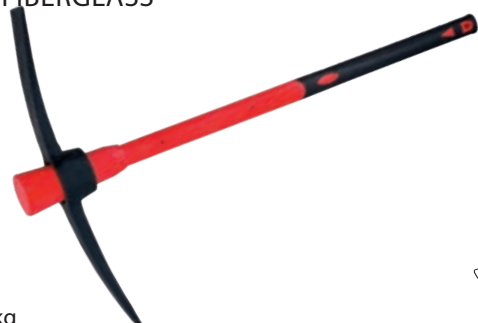

61065 2,5 kg



1

ÁLLNI LAPÁT ÉS ÁSÓ  
STAND

NEW



61078 Pouze rám bez palety/ Only frame  
61079



1

1



ÚTTEST SEPRŰ  
MATURA (PERIE)

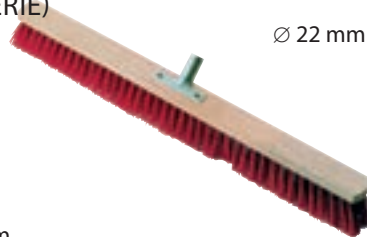

Ø 22 mm



<b>52101</b>	30 cm	10
<b>52102</b>	40 cm	10
<b>52103</b>	50 cm	10
<b>52104</b>	60 cm	10
<b>52105</b>	80 cm	10

ÚTTEST SEPRŰ  
MATURA (PERIE)

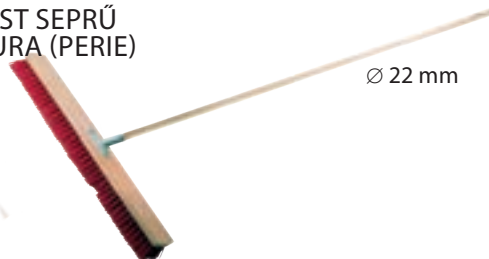

Ø 22 mm



<b>52190</b>	30 cm, nyél/Cooda lemn 150 mm	10
<b>52191</b>	40 cm, nyél/Cooda lemn 150 mm	10
<b>52192</b>	50 cm, nyél/Cooda lemn 150 mm	10
<b>52193</b>	60 cm, nyél/Cooda lemn 150 mm	10
<b>52194</b>	80 cm, nyél/Cooda lemn 150 mm	10

ÚTTEST SEPRŰ  
MATURA (PERIE)

NEW



<b>52160</b>	40 cm	1
<b>52161</b>	50 cm	1
<b>52162</b>	60 cm	1
<b>52163</b>	70 cm	1
<b>52164</b>	80 cm	1

ÚTTEST SEPRŰ  
MATURA (PERIE)

NEW



Ø 22 mm



<b>52185</b>	40 cm	1
<b>52186</b>	50 cm	1
<b>52187</b>	60 cm	1
<b>52188</b>	70 cm	1
<b>52189</b>	80 cm	1

TEREMPARTVIS  
MATURA



<b>52113</b>	30 cm, menetes / filet	1
<b>52115</b>	30 cm	1

TEREMPARTVIS  
MATURA



Ø 22 mm



<b>52196</b>	30 cm, nyél/Cooda 130 mm, ALU	1
<b>52195</b>	30 cm, nyél/Cooda 150 mm, dřevo/wood	1

SEPRŰ  
MATURA (PERIE)



<b>52108</b>	25 cm, nyél/Cooda Ø 22 mm	25
--------------	---------------------------	----

ÚTTEST SEPRŰ  
MANER MATURA



<b>52109</b>	25 cm, 13 cm bristles/Perie 13 cm inaltime	1
--------------	--	---

NYÉL  
COADA LEMN



<b>61171</b>	1,2m	25
<b>61173</b>	1,4m	25
<b>61174</b>	1,5m	25
<b>61175</b>	1,6m	25
<b>61176</b>	1,7m	25
<b>61177</b>	1,8m	25

NYÉL  
COADA

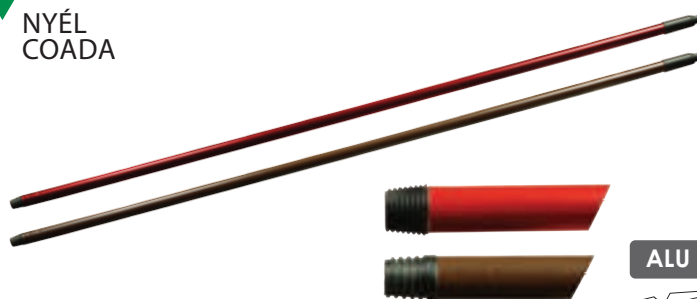

<b>52125</b>	130 cm, finom menetes / filet fin	1
<b>52126</b>	130 cm, menetes / filet	1

▼ SZEMÉTLAPÁT ÉS SEPRŰ  
FARAS + PERIE SET



**52168** gumiéllel / cu lamela de cauciuc



24

▼ SZEMÉTLAPÁT ÉS SEPRŰ  
FARAS + PERIE SET



**52173**



24

▼ SEPRŰ  
PERIE DE MANA



**52119** 29 cm



1

▼ ÚTSZORÓ SÓ  
SARE RUTIER



**43300** 10 kg  
**43301** 25 kg



1

1

HÓLAPÁT - GYEREKEK  
LOPATA PENTRU ZAPADA - COPII

NEW

60013 29 x 22 x 900 cm, kék / albastru  
60014 29 x 22 x 900 cm, piros / roșu10  
10HÓLAPÁT  
LOPATA PENTRU ZAPADA

FESTA®

60006 46 x 34cm  
60008 50 x 34cm1  
1HÓLAPÁT  
LOPATA PENTRU ZAPADA

60000 50 x 40cm



10

HÓLAPÁT  
LOPATA PENTRU ZAPADA

60001 48 x 40 cm



10

HÓLAPÁT  
LOPATA PENTRU ZAPADA

60002 48 x 37 cm



10

HÓLAPÁT  
LOPATA PENTRU ZAPADA

60005 39 x 33 cm



10

HÓLAPÁT  
LOPATA PENTRU ZAPADA

60003 39 x 33 cm



10

HÓLAPÁT  
LOPATA PENTRU ZAPADA

60012 50 x 38 cm



10

ALU

JÉGTÖRŐ  
RACLETA GHEATA

60022 20 cm



1

JÉGTÖRŐ  
SPARGATOR GHEATA60018 15 cm  
60019 20 cm  
60020 30 cm40  
36  
20

LAPÁTNYÉL  
MANER LOPATA



61200 130 cm



10

LAPÁTNYÉL LAPOS  
MANER HARLET



61201 130 cm



10

„T” LAPÁTNYÉL  
MANER HARLET „T”



61202 130 cm



10

ÁSÓNYÉL „T” FOGANTYÚ  
MANER CAZMA



61208 90 cm, „T”



10

ÁSÓNYÉL „Y” FOGANTYÚ  
MANER CĂZMA

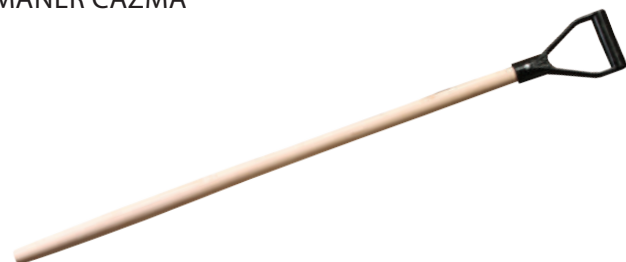

61207 100 cm, „Y”



10

LOMBSEPRŰ NYÉL  
MANER CĂNCIOG



61215 160 cm



10

CSÁKÁNY NYÉL  
MANER TOPOR



61205 95 cm



10

CSÁKÁNY NYÉL FIBERGLASS  
MANER TOPOR FIBERGLASS



61206



10

LOMBSEPRŰ NYÉL  
MANER CĂNCIOG



sistem click  
ON-OFF

45330 161 cm  
45331 100 cm



10

„Y” FOGANTYÚ  
MANER



61230



10

CSÁKÁNY NYÉL  
MANER TOPOR



NEW



61219 120 cm



10

LOMBSEPRŰ GEREBLYE  
MANER GREBLÁ



NEW

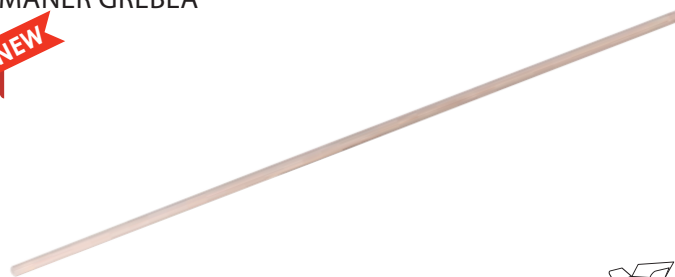

61195 150 cm



10

LOMBSEPRŰ NYÉL  
MANER CANCIOG



NEW



61183	150 cm	10
61184	160 cm	10
61189	170 cm	10
61190	180 cm	10



10

LOMBSEPRŰ NYÉL  
MANER COADA



61171	120 cm	10
61173	140 cm	10
61174	150 cm	10
61175	160 cm	10
61176	170 cm	10
61177	180 cm	10

10

10

10

10

10

10

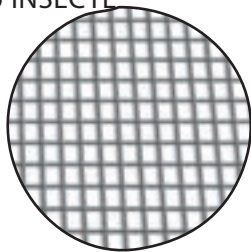
SZÚNYOGHÁLÓ  
PLASA PENTRU INSECTE

<b>42101</b>	1x30 m - ALUMINIUM	2
<b>42103</b>	1x30 m - galvanizált / sarma galvanizata	2

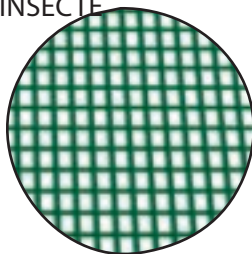
SZÚNYOGHÁLÓ FÉM FESTETT  
PLASA PENTRU INSECTE  
SARMA VERDE

<b>42102</b>	1x30 m - zöld/ verde	2
--------------	-------------------------	---

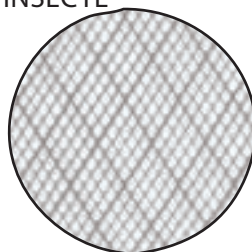
SZÚNYOGHÁLÓ - PE MŰANYAG  
PLASA PENTRU INSECTE

<b>40100</b>	1x25 m	PE fehér/alba	1
<b>40120</b>	1,2x25 m	PE fehér/alba	1

SZÚNYOGHÁLÓ - SZÜRKE  
PLASA PENTRU  
FEREASTRA - GRI

tépőzáras / velcro

<b>40051</b>	150x130 cm	5,6 m	1
<b>40053</b>	150x180 cm	6,6 m	1
<b>40055</b>	150x90 cm	4,8 m	1

SZÚNYOGHÁLÓ - PE MŰANYAG  
PLASA PENTRU INSECTE

<b>40060</b>	9 mm / 7 m self-adhezeve burband for window net	1
--------------	--	---

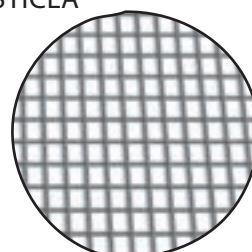
SZÚNYOGHÁLÓ - ÜVEGSZÁLAS  
PLASA FIBRA STICLA

<b>41050</b>	0,5x30 m	szürke/gri	6
<b>41080</b>	0,8x30 m	szürke/gri	6
<b>41100</b>	1x30 m	szürke/gri	6
<b>41120</b>	1,2x30 m	szürke/gri	6
<b>41150</b>	1,5x30 m	szürke/gri	6
<b>41081</b>	0,8x30 m	fekete/neagra	6
<b>41101</b>	1x30 m	fekete/neagra	6
<b>41121</b>	1,2x30 m	fekete/neagra	6
<b>41151</b>	1,5x30 m	fekete/neagra	6
<b>41083</b>	0,8x30 m	fehér/alba	6
<b>41103</b>	1x30 m	fehér/alba	6
<b>41123</b>	1,2x30 m	fehér/alba	6
<b>41153</b>	1,5x30 m	fehér/alba	6
<b>41082</b>	0,8x30 m	fehér-szürke/alba-gri	6
<b>41102</b>	1x30 m	fehér-szürke/alba-gri	6
<b>41122</b>	1,2x30 m	fehér-szürke/alba-gri	6
<b>41152</b>	1,5x30 m	fehér-szürke/alba-gri	6

SZÚNYOGHÁLÓ - FEHÉR  
PLASA PENTRU  
FEREASTRA - ALBA

tépőzáras / velcro

<b>40050</b>	150x130 cm	5,6 m	1
<b>40052</b>	150x180 cm	6,6 m	1
<b>40054</b>	150x90 cm	4,8 m	1
<b>40056</b>	2 db/but, 220x75 cm	5,8 m	1

SZÚNYOGHÁLÓ - FEKETE  
PLASA PENTRU  
FEREASTRA - NEAGRA

tépőzáras / velcro

<b>40057</b>	150x130 cm	5,6 m	1
<b>40058</b>	150x180 cm	6,6 m	1
<b>40059</b>	150x90 cm	4,8 m	1

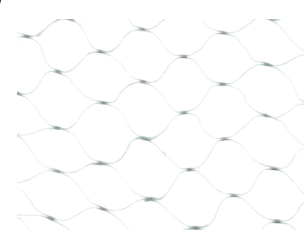
MADÁRVÉDŐ HÁLÓ  
NET DE PĂSĂRILE

<b>45570</b>	zöld/ verde	2 x 5 m	18 x 18 mm	1
<b>45571</b>	zöld/ verde	2 x 10 m	18 x 18 mm	1
<b>45572</b>	zöld/ verde	4 x 5 m	18 x 18 mm	1
<b>45573</b>	zöld/ verde	4 x 10 m	18 x 18 mm	1



**SZÚNYOGHÁLÓ  
PERDEA**



Változó méret /marime variabila  
szélesség /latime 60-120 cm  
magasság /inalt. max. 220 cm



<b>40075</b>	4x35x220 cm, polyester, fehér/alba	1
<b>40076</b>	4x35x220 cm, polyester, fekete/neagra	1

**DRÓTHÁLÓ HATSZÖG, ZINC  
PLASA SARMA ZINCATA HEXAGONALA**



Zn

Fonás előtt horganyzott  
zincare inainte de impletire



<b>42155</b>	13/0,7x1000 mm - 50 m	1
<b>42156</b>	16/0,7x1000 mm - 50 m	1
<b>42157</b>	20/0,7x1000 mm - 50 m	1
<b>42158</b>	25/0,8x1000 mm - 50 m	1

**DRÓTHÁLÓ HATSZÖG, ZINC  
PLASA SARMA ZINCATA HEXAGONALA**



Zn

Fonás után horganyzott  
zincare dupa impletire



<b>42150</b>	13/0,7x1000 mm - 50 m	1
<b>42151</b>	16/0,7x1000 mm - 50 m	1
<b>42152</b>	20/0,7x1000 mm - 50 m	1
<b>42153</b>	25/0,8x1000 mm - 50 m	1

**DRÓTHÁLÓ HATSZÖG, MŰANYAG  
PLASA PLASTIC HEXAGONALA**

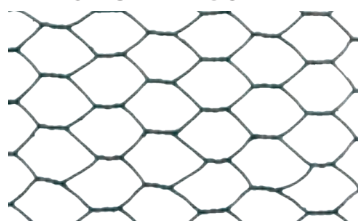

Zn



<b>42160</b>	13/1x1000 mm - 25 m	1
<b>42161</b>	16/1x1000 mm - 25 m	1
<b>42162</b>	20/1x1000 mm - 25 m	1
<b>42163</b>	25/1x1000 mm - 25 m	1

**KERÍTÉSFONAT, PVC BEVONAT, ZÖLD  
PLASA GARD PATRATE, PVC**

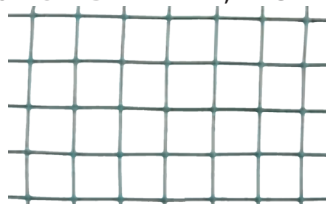

<b>42180</b>	13/1,2x1000 mm - 25 m	1
<b>42181</b>	16/1,2x1000 mm - 25 m	1
<b>42182</b>	25/2,3x1000 mm - 25 m	1

**DRÓTHÁLÓ NÉGYZET, ZINC  
PLASA SARMA RECTANGULARA Zn**

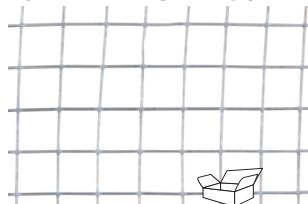

Zn



<b>42170</b>	10/0,8x1000 mm - 25 m	1	<b>42185</b>	6/0,65x1000 mm - 25 m	1
<b>42171</b>	13/0,8x1000 mm - 25 m	1	<b>42186</b>	13/1,5x1000 mm - 25 m	1
<b>42172</b>	16/1,2x1000 mm - 25 m	1	<b>42187</b>	25/2,0x1000 mm - 25 m	1
<b>42173</b>	19/1,4x1000 mm - 25 m	1	<b>42188</b>	50/2,0x1000 mm - 25 m	1
<b>42174</b>	25/1,4x1000 mm - 25 m	1			

**DRÓTHÁLÓ RABICO  
PLASA RABICO**

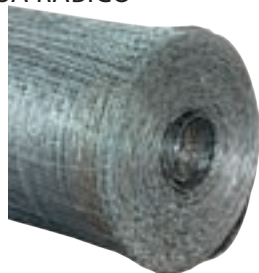

<b>42312</b>	1 m / 50 bm 16 x 16 mm	1
--------------	------------------------	---

**DÍSZ DRÓTKERÍTÉS PVC  
PLASA GARD PVC**



<b>42175</b>	15x9 cm, 2 mm	0,4x25 m	1
<b>42176</b>	15x9 cm, 2 mm	0,65x25 m	1
<b>42177</b>	15x9 cm, 2 mm	0,9x25 m	1
<b>42178</b>	15x9 cm, 2 mm	1,2x25 m	1
<b>42179</b>	15x9 cm, 2 mm	0,25x25 m	1

**FATÖRZS VÉDŐHÁLÓ  
PROTECTIE POMI CONTRA ROADERII CU  
ÎNCHIDERE AUTOMATĂ, DIAM**

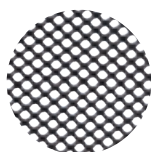

<b>45580</b>	∅ 11 x 80 cm	3 db/buc	1
<b>45581</b>	∅ 6 x 55 cm	3 db/buc	1

**KÖTÖZŐDRÓT  
SARMA**

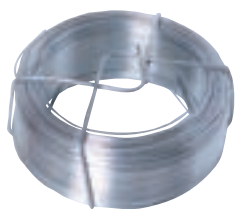

<b>42201</b>	∅ 0,6 mm x 30 m	zöld mű.a bevonat/trasa in PVC verde	50
<b>42202</b>	∅ 0,9 mm x 30 m	zöld mű.a bevonat/trasa in PVC verde	50
<b>42203</b>	∅ 0,6 mm x 30 m	Zn	50

KÖTÖZŐDRÓT Zn  
SARMA ZINCATA

Zn

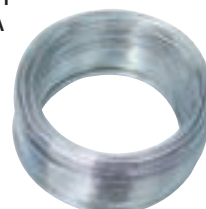

42208	Ø 0,8 mm x 100 m	20
42209	Ø 0,9 mm x 100 m	20
42210	Ø 1,0 mm x 100 m	20
42212	Ø 1,2 mm x 100 m	20
42214	Ø 1,4 mm x 50 m	20
42218	Ø 1,8 mm x 50 m	20

KÖTÖZŐDRÓT Zn  
SARMA ZINCATA

Zn



42219	Ø 2,0 mm x 26 m	20
42220	Ø 2,0 mm x 52 m	20
42221	Ø 2,0 mm x 78 m	20
42228	Ø 3,15 mm x 26 m	10
42229	Ø 3,15 mm x 52 m	10
42230	Ø 3,15 mm x 78 m	10

KÖTÖZŐ PVC  
SARMA INVELITA IN PVC

42251	Ø 2,6 mm x 26 m	20
42252	Ø 2,6 mm x 52 m	20
42253	Ø 2,6 mm x 78 m	20
42255	Ø 3,4 mm x 26 m	20
42256	Ø 3,4 mm x 52 m	10
42257	Ø 3,4 mm x 78 m	10

KÖTÖZŐ PVC  
SARMA INVELITA IN PVC

42244	Ø 1,4 mm x 50 m	20
42248	Ø 1,8 mm x 50 m	20
42249	Ø 2,0 mm x 50 m	20

SZÖGESDRÓT Zn  
SARMĂ GHIMPATĂ

Zn



42260	Ø 2 mm x 50 m	20
42261	Ø 2 mm x 100 m	20

FESZÍTŐDRÓT KAPOCS, ROZSDAMENTES VÉG  
CLEMA PRINDERE CABLURI

50040	zöld / verde	100
50041	fekete / neagra	100

DRÓT FESZÍTŐ  
INTINZATOR DE CABLURI

Zn



50030	vékony Zn bevonat / Zincare usoara	50
50031	masszív Zn bevonat / Zincare masiva	50
50032	vékony műanyag bevonat / acoperire usoara cu PVC	50
50033	masszív műanyag bevonat / acoperire masiva cu PVC	50

DRÓT FESZÍTŐ  
INTINZATOR DE CABLURI

NEW



Zn



50037	pozink malý/small Zn coated	50
50038	PVC malý/small PVC coated	50

FESZÍTŐDRÓT KAPOCS  
CLEMA PRINDERE CABLURI

50042		10
-------	--	----

KÉZI CSÖRLŐ  
CRIC FIXARE CHINGI

50035	2t	10
50036	4t	4



OSZLOPTALP Zn  
TARUS METALIC Zn



Zn



55443	∅ 80 x 750mm	tl. 2mm	1
55444	∅ 100 x 750mm	tl. 2mm	1
55445	∅ 120 x 750mm	tl. 2mm	1

OSZLOPTALP Zn  
TARUS METALIC Zn



Zn



55400	71 x 71 x 750 mm	tl. 2 mm	1
55401	91 x 91 x 750 mm	tl. 2 mm	1
NEW 55406	81 x 81 x 750 mm	tl. 2 mm	1
55402	91 x 91 x 900 mm	tl. 2 mm	1
55403	101 x 101 x 900 mm	tl. 2 mm	1
55404	121 x 121 x 900 mm	tl. 2 mm	1
55405	151 x 151 x 900 mm	tl. 2 mm	1

OSZLOPTALP Zn  
TARUS METALIC Zn



Zn



55440	∅ 80 x 150mm	tl. 2mm	1
55441	∅ 100 x 150mm	tl. 2mm	1
55442	∅ 120 x 150mm	tl. 2mm	1

OSZLOPTALP Zn  
TARUS METALIC Zn



Zn



55420	71 x 71 x 150 mm	tl. 2 mm	1
NEW 55425	81 x 81 x 150 mm	tl. 2 mm	1
55421	91 x 91 x 150 mm	tl. 2 mm	1
55422	101 x 101 x 150 mm	tl. 2 mm	1
55423	121 x 121 x 150 mm	tl. 2 mm	1
55424	151 x 151 x 150 mm	tl. 2 mm	1

OSZLOPTARTÓ „U”  
ANCORE PENTRU TIJA „U”



Zn



55436	70 x 75 x 110 x 200, tl.4 mm, 18 mm	L	10
55437	80 x 90 x 130 x 200, tl.4 mm, 18 mm	L	10
55429	70 x 60 x 100 x 200, tl.4 mm, 18 mm	U	10
NEW 55433	81 x 60 x 100 x 200, tl.4 mm, 18 mm	U	10
55430	91 x 60 x 100 x 200, tl.4 mm, 18 mm	U	10
55431	101 x 60 x 100 x 200, tl.4 mm, 18 mm	U	10
55432	121 x 60 x 100 x 200, tl.4 mm, 18 mm	U	10

ÁLLÍTHATÓ OSZLOP TARTÓ TALP TALPĂ  
STĂLP REGLABILĂ CU ȘURUB



Zn



55460	80 x 80	M16	160 mm	10
55461	100 x 100	M16	200 mm	10
55462	150 x 150	M24	250 mm	10

SZLOPOT LEHORGANYZÓ CSAVAROS TŰSKE „U”  
KIT UNIVERSAL ANCORARE



Zn



55455	70 x 60 x 100	tl. 4 mm	8
NEW 55452	81 x 60 x 100	tl. 4 mm	8
55456	90 x 60 x 100	tl. 4 mm	8
NEW 55453	101 x 60 x 100	tl. 4 mm	8
55457	110 x 60 x 100	tl. 4 mm	8
NEW 55454	121 x 60 x 100	tl. 4 mm	8

UNIVERZÁLIS TALAJ RÖGZÍTŐ CSAVAR  
KIT UNIVERSAL ANCORARE



redukce/reduction  
∅ 24 mm  
∅ 35 mm  
∅ 40 mm  
∅ 48 mm  
∅ 55 mm

Zn



55450	60mm, 1db/buc+5db/buc reduction	8
-------	---------------------------------	---

FÖLDFŰRŐ  
BURGHU DE SOL



Zn



NEW 61299	110 mm	1
61300	140 mm	1
NEW 61301	170 mm	1
NEW 61302	200 mm	1

BAMBUS DEKORNÁD  
PARAVAN BAMBUS

<b>45410</b>	1 m x 5 m	1
<b>45415</b>	1,5 m x 5 m	1
<b>45420</b>	2 m x 5 m	1

DEKORÁCIÓS NÁD  
ROGOJINA

<b>45425</b>	1 m x 5 m	1
<b>45426</b>	1,5 m x 5 m	1
<b>45427</b>	2 m x 5 m	1

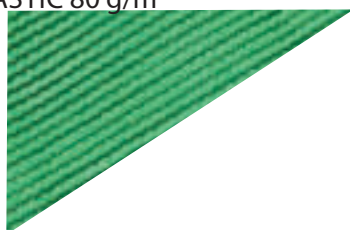
ÁRNYÉKOLÓTEXTIL HDPE 80 g/m<sup>2</sup>  
PLASA PLASTIC 80 g/m<sup>2</sup>80 g/m<sup>2</sup>

<b>45450</b>	UV stabil/stabilitate	1 m x 10 m	1
<b>45451</b>	UV stabil/stabilitate	1,5 m x 10 m	1
<b>45452</b>	UV stabil/stabilitate	2 m x 10 m	1
<b>45453</b>	UV stabil/stabilitate	1,8 m x 10 m	1

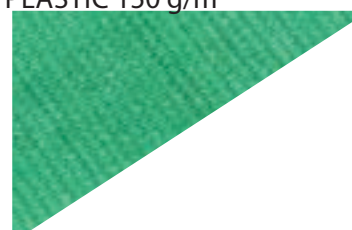
ÁRNYÉKOLÓTEXTIL HDPE 150 g/m<sup>2</sup>  
PLASA PLASTIC 150 g/m<sup>2</sup>árnyékolás /armat 85%  
150 g/m<sup>2</sup>

<b>45460</b>	UV stabil/stabilitate	1 m x 10 m	1
<b>45461</b>	UV stabil/stabilitate	1,5 m x 10 m	1
<b>45462</b>	UV stabil/stabilitate	2 m x 10 m	1
<b>45463</b>	UV stabil/stabilitate	1,8 m x 10 m	1

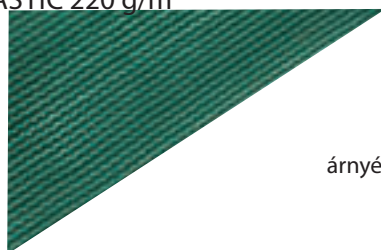
ÁRNYÉKOLÓTEXTIL HDPE 220 g/m<sup>2</sup>  
PLASA PLASTIC 220 g/m<sup>2</sup>árnyékolás /armat 90%  
220 g/m<sup>2</sup>

<b>45465</b>	UV stabil/stabilitate	1 m x 10 m	1
<b>45466</b>	UV stabil/stabilitate	1,5 m x 10 m	1
<b>45467</b>	UV stabil/stabilitate	2 m x 10 m	1

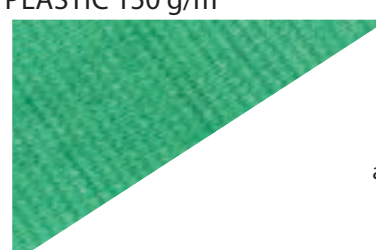
ÁRNYÉKOLÓTEXTIL HDPE 150 g/m<sup>2</sup>  
PLASA PLASTIC 150 g/m<sup>2</sup>árnyékolás /armat 85%  
150 g/m<sup>2</sup>

<b>45480</b>	UV stabil/stabilitate	1,5 m x 50 m	1
--------------	-----------------------	--------------	---

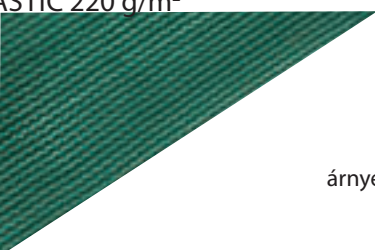
ÁRNYÉKOLÓTEXTIL HDPE 220 g/m<sup>2</sup>  
PLASA PLASTIC 220 g/m<sup>2</sup>árnyékolás /armat 90%  
220 g/m<sup>2</sup>

<b>45485</b>	UV stabil/stabilitate	1,5 m x 50 m	1
--------------	-----------------------	--------------	---

ÁRNYÉKOLÓ RÖGZÍTŐ  
CLEMĂ PRINDERE TEXTIL PENTRU UMBRĂ

<b>45470</b>	10 db/buc	1
--------------	-----------	---

GRILLEZŐ KLT.  
SET BARBECUE

INOX



<b>43077</b>	18 db/buc	6
--------------	-----------	---

GRILLEZŐ KLT.  
SET BARBECUE

INOX



<b>43071</b>	3 db/buc 38 cm	20
--------------	----------------	----

GRILLEZŐ FOGÓ  
BARBECUE CLESTE

43072 38 cm



36

ALU GRILL TÁLCA  
FARFURIE GRILL ALU

43050 4 db/buc

ALU

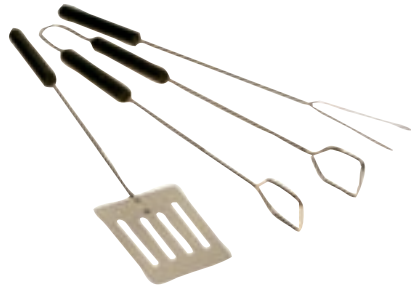

100

GRILLEZŐ KLT.  
SET BARBECUE

43073 3 db/buc

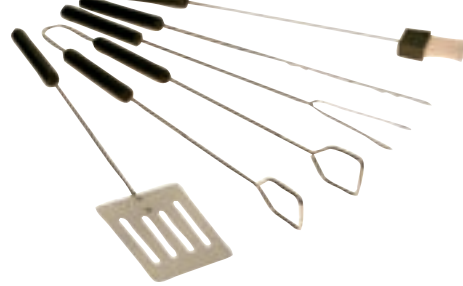

36

GRILLEZŐ KLT.  
SET BARBECUE

43075 5 db/buc

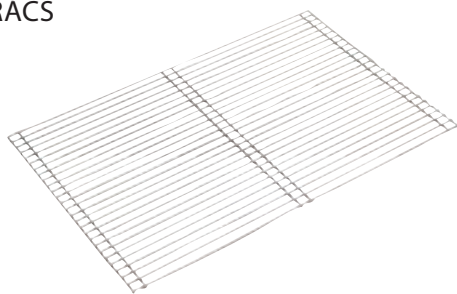

36

GRILL RÁCS  
GRILL

43058 58 x 30 cm



20

43060 60 x 40 cm

20

43068 68 x 40 cm

20

GRILL CSIPESZ  
CLESTE

43080



1

GRILL RÁCS, KERÉK  
GRATAR

43081 Ø290mm

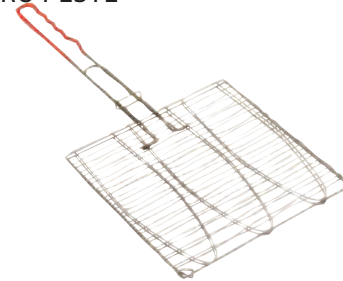

24

HAL GRILLEZŐ  
GRATAR PENTRU PESTE

43082 280 x 276 mm



24

HAL GRILLEZŐ  
GRATAR PENTRU PESTE

43083 360 x 130 mm

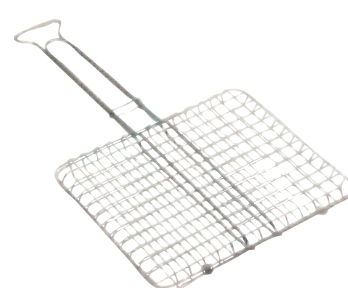

48

HÚS GRILLEZŐ  
GRATAR

43084 330 x 290 mm



20

SASLIK GRILL NYÁRS, LAPOS, FA NYÉL  
TIJE FRIGARUI

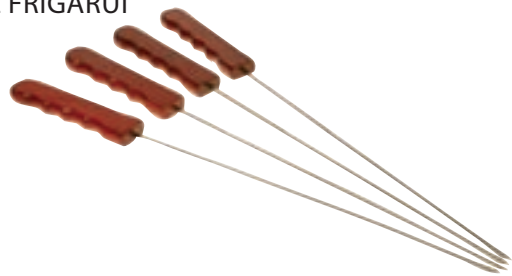

43088 4 db/buc, 50 cm



36

SASLIK GRILL NYÁRS  
TIJE FRIGARUI

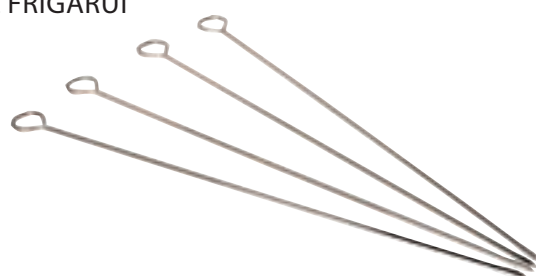

43086 4 db/buc 380 x Ø 3 mm



96

LÉGFUVÓ, MECH.  
COMPRESOR



43087



60

VILLA  
GRILL TIJA



43097 100 cm, Egészségügyi bizonyítvánnyal/ cu atestare pentru igiena



72

GRILL FORGATÓ MOTOR ELKTR. 220V  
COMPRESOR PENTRU GRATAR 230V



43090



24

GRILL FORGATÓ MOTOR ELEMES  
COMPRESOR PENTRU GRATAR



43089



48

GYÚJTÓS  
COMBUSTIBIL SOLID



43095 Pevný/ Solid  
43096 Tekutý/ Liquid



20

6

GRILLKAPARÓ  
PERIE BARBECUE



43098 30 cm



72

GRILL TISZTÍTÓ KEFE  
PERIE 3 IN 1



43099



72

FA SZÉN  
DE CARBUNE DIN LEMN



43110 fa szén/ de carbune din lemn  
43111 grill brikett / brichete gratar



1

1

ZÁRBETÉT NIKKELEL BEVONT  
BUTUC YALA LUNG NICHEL ACOPERIT



**23000** 65 mm



12

ZÁRBETÉT NIKKELEZETT  
BUTUC YALA LUNG

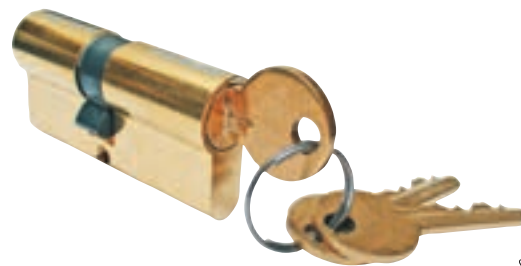

**23001** 65 mm



12

SÁRGARÉZ LAKAT  
LACAT



**23020** 20 mm  
**23025** 25 mm  
**23030** 30 mm  
**23035** 35 mm  
**23040** 40 mm  
**23045** 45 mm  
**23050** 50 mm  
**23060** 60 mm



12

12

12

12

12

12

12

12

SÁRGARÉZ LAKAT  
LACAT LUNG



**23070** 40 mm



12

ERŐSÍTETT SÁRGARÉZ LAKAT  
LACAT RANFORSAT



**23125** 25 mm  
**23130** 30 mm  
**23135** 35 mm  
**23140** 40 mm  
**23150** 50 mm  
**23160** 60 mm



12

12

12

12

12

12

12

VAS LAKAT  
LACAT FIER



**23220** 20 mm  
**23225** 25 mm  
**23232** 32 mm  
**23240** 40 mm  
**23250** 50 mm  
**23260** 60 mm



12

12

12

12

12

12

12

LAKAT  
LACAT

**FESTA**<sup>®</sup>



**23261** 25 mm  
**23262** 32 mm  
**23263** 38 mm



12

12

12

**23264** 45 mm  
**23265** 52 mm  
**23266** 63 mm



12

12

12

LAKAT  
LACAT



**23273** 50 mm  
**23274** 60 mm  
**23275** 70 mm



12

12

12

LAKAT  
LACAT



**23012** 50 mm



12

LAKAT  
LACAT



**23010** 50 mm



12

LAKAT, VÍZBIZTOS  
LACAT IZOLAT CONTRA APEI



23005 40 mm  
23006 60 mm



KEREKPÁR LAKAT  
LACAT BICICLETA



23281



KEREKPÁR LAKAT  
LACAT BICICLETA



23288 120 cm x Ø 10 mm



KEREKPÁR LAKAT  
LACAT BICICLETA



23287 65 cm x Ø 10 mm



KEREKPÁR LAKAT  
LACAT BICICLETA

FESTA®



23295 120 cm x Ø 8 mm  
23296 150 cm x Ø 8 mm  
23297 180 cm x Ø 8 mm



KEREKPÁR LAKAT  
LACAT BICICLETA

FESTA®



23290 120 cm x Ø 8 mm  
23291 150 cm x Ø 8 mm  
23292 180 cm x Ø 8 mm



KULCSJELZŐ  
BRELOCURI TIP ETICHETA



23390 100 db/buc



KEREKPÁR LAKAT  
LACAT BICICLETA



23282 55 mm/Ø 8 mm  
23284 65 mm/Ø 8 mm



KULCSJELZŐ  
BRELOCURI TIP ETICHETA

FESTA®



erősebb kör/ circle puternică

23391 100 bd/buc



KULCSSZEKRÉNY  
CUTIE



70140 250 x 180 x 80 mm - 48 kulcsra/ pentru 48 de chei 12  
70141 300 x 230 x 90 mm - 90 kulcsra/ pentru 90 de 8



KASSZA  
CA SETA PENTRU BANI



**70120** 125 x 95 x 60 mm



50

KASSZA  
CA SETA PENTRU BANI



**70121** 152 x 118 x 80 mm



30

KASSZA  
CA SETA PENTRU BANI



**70122** 200 x 160 x 90 mm



20

KASSZA  
CA SETA PENTRU BANI



**70123** 250 x 180 x 90 mm



16

KASSZA  
CA SETA PENTRU BANI



**70124** 300 x 240 x 90 mm



10

KASSZA  
CA SETA PENTRU BANI



**70125** 370 x 280 x 90 mm



8

POSTALÁDA  
CUTIE POSTALA



**70100** 290 x 360 x 105mm barna/maro  
**70101** 290 x 360 x 105mm fehér/alb



4

4

POSTALÁDA  
CUTIE POSTALA



**70102** 310 x 260 x 90mm fehér/alb  
**70103** 310 x 260 x 90mm barna/maro



6

6

POSTALÁDA  
CUTIE POSTALA



**70104** 310 x 360 x 90mm fehér/alb  
**70105** 310 x 360 x 90mm barna/maro



6

6

POSTALÁDA  
CUTIE POSTALA



**70106** 360 x 360 x 100mm rozsdamentes/inox



5

**INOX**

POSTALÁDA  
CUTIE POSTALA



INOX



**70107** 360 x 520 x 100mm rozsdamentes/inox

6

POSTALÁDA  
CUTIE POSTALA



**70108** 370 x 364 x 134mm fehér/alb



5

POSTALÁDA  
CUTIE POSTALA



INOX



**70109** 310 x 260 x 90mm rozsdamentes/inox

6

POSTALÁDA  
CUTIE POSTALA



INOX



**70110** 310 x 360 x 90mm rozsdamentes/inox

6

POSTALÁDA  
CUTIE POSTALA



**70113** 240 x 105 x 345mm  
**70114** 240 x 105 x 345mm



1

1

SPANIFER  
CHINGI



FESTA<sup>®</sup>



<b>51040</b>	25mm x 6 m	TUV GS 1000kg	1
<b>51041</b>	35mm x 8 m	TUV GS 2000kg	1
<b>51042</b>	35mm x 8 m	TUV GS 3000kg	1
<b>51043</b>	50mm x 10 m	TUV GS 5000kg	1

SPANIFER  
CHINGI

FESTA<sup>®</sup>



**51060** 1" x 5 m TUV GS 750kg 2db/buc

10

SPANIFER  
CHINGI

FESTA<sup>®</sup>



**51065** 2" x 10 m TUV GS 1200kg 1db/buc

6

SPANIFER  
CHINGI



**51026** 75 mm x 5 m 3000kg 2db/buc

1

SPANIFER  
CHINGI



<b>51017</b>	2" x 6 m, 2 db/buc, 480kg	1
<b>51018</b>	2" x 6 m, 1 db/buc, 480kg	1

1



SPANIFER  
CHINGI



**51020** 25 mm x 5 m



100

SPANIFER  
CHINGI



**51022** 25 mm x 5 m  
**51023** 50 mm x 5 m



40

10

SPANIFER  
CHINGI



**51030** 6 m x 50 mm  
**51034** 8 m x 50 mm



20

10

RAKOMÁNYRÖGZÍTŐ ÁLLÍTHATÓ  
COARDE BANDA REGLABIL

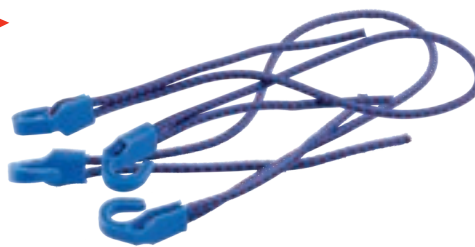

**51013** 2ks Ø 8mm 1,2m



50

RAKOMÁNYRÖGZÍTŐ  
COARDE BANDA



**51008** 2 x 1 m 70kg



50

RAKOMÁNYRÖGZÍTŐ  
COARDE BANDA



**51009** 1 m



50

RAKOMÁNYRÖGZÍTŐ KÉSZLET  
SET FRANGHII



**51011** 2 x 0,4, 0,6, 0,8, 1 m



1

GUMIPÓK  
COARDE ELASTICE



**51007** 2 x 1 m



50

GUMIPÓK  
COARDE ELASTICE



**51001** 80 cm x 8 mm 2 db/buc 50  
**51002** 100 cm x 8 mm 2 db/buc 50  
**51003** 150 cm x 8 mm 2 db/buc 50  
**51004** 200 cm x 8 mm 2 db/buc 50



50

50

50

50

GUMIPÓK  
COARDE ELASTICE



**51010** 80 cm x 8 mm - 8 ágú/carlige



50

HORGOK  
CARLIGE

NEW



51038 8mm 20 db/ bud



50

GUMIKÖTÉL  
BANDA ELÁSTICA PENTRU FIXARE BAGAJE51036 20 m x 8 mm  
51037 20 m x 10 mm

10

6

GUMI HÁLÓ  
PLASA ELASTICE

51015 80 cm x 120 cm



50

KÖTÉL  
FRANGHIE

50915	8 mm x 5 m	1
NEW 50914	8 mm x 10 m	1
50916	8 mm x 25 m	1
50917	10 mm x 25 m	1
50918	12 mm x 25 m	1
50919	14 mm x 25 m	1



1

1

1

1

1

1

ZSINÓR PE.  
SNUR NYLON51055 1,5 mm x 80 m  
51056 2 mm x 50 m  
51057 4 mm x 20 m

50

50

75

KÖTÉL PE.  
FRANGHIE NYLON51050 8 mm x 50 m  
51051 10 mm x 50 m  
51053 14 mm x 50 m

10

10

10

MÜANYAGZSINEG  
FIR PP50905 80 g  
50906 100 g  
50907 200 g

80

100

50

MÜANYAGZSINEG  
FIR PP

NEW

50909 500 g  
50910 1000 g  
50911 5000 g

1

1

1

KENDERZSINEG  
FIR IUTA50900 80 g  
50901 100 g  
50902 200 g

80

80

50

VIASZOLT ZSINEG  
SFORII CERATA

NEW



50920 Ø 2 mm 50m



80

ZSINEG  
FIR

NEW



50925 Ø 1 mm 50 m



80

RAGASZTÓ PISZTOLY  
PISTOL DE LIPIT

89973 60W / 240V, Ø 11,2 mm



20

RAGASZTÓ PISZTOLY  
PISTOL DE LIPIT

89970 15W / 240V, Ø 7,2 mm



20

OLVASZTÓ PÁLCIKA, ÁTLÁTSZÓ  
REZERVE BATON PLASTIC, TRANSPARENT

89980 Ø 7,2 x 100 mm, 12db/buc  
89985 Ø 11,2 x 200 mm, 10db/buc  
89987 Ø 11,2 x 200 mm, 1kg



1

1

1

KÁBELKÖTŐZŐ  
BRIDE PLASTIC CABLURIEN 50146  
nylon

23810 120 x 2,5 mm, 50 db/buc  
23814 200 x 3,6 mm, 50 db/buc  
23816 250 x 3,6 mm, 50 db/buc  
23818 250 x 4,8 mm, 50 db/buc  
23820 300 x 4,8 mm, 50 db/buc  
23824 400 x 4,8 mm, 50 db/buc  
23826 500 x 4,8 mm, 50 db/buc  
23828 400 x 7,6 mm, 50 db/buc  
23830 500 x 7,6 mm, 50 db/buc

1

1

1

1

1

1

1

1

1

1

KÁBELKÖTŐZŐ  
BRIDE PLASTIC CABLURIEN 50146  
nylon

23850 120 x 2,5 mm, 50 db/buc  
23854 200 x 3,6 mm, 50 db/buc  
23856 250 x 3,6 mm, 50 db/buc  
23858 250 x 4,8 mm, 50 db/buc  
23860 300 x 4,8 mm, 50 db/buc  
23864 400 x 4,8 mm, 50 db/buc  
23866 500 x 4,8 mm, 50 db/buc  
23868 400 x 7,6 mm, 50 db/buc  
23870 500 x 7,6 mm, 50 db/buc

1

1

1

1

1

1

1

1

1

1

KÁBELKÖTŐZŐ, SZÍNES  
BRIDE PLASTIC, COLORATEEN 50146  
nylon

23880 100 x 2,5 mm, 100 db/buc  
23882 150 x 2,5 mm, 100 db/buc  
23884 200 x 3,6 mm, 100 db/buc

1

1

1

ALUMÍNÍUM KARABIN  
CARABINE ALUMINIU

ALU



51200 6 mm x 60 mm  
51201 8 mm x 80 mm

2

2

RUGÓSMÉRLEG  
CANTAR DE BUZUNAR

24212 12,5 kg  
24225 25 kg  
24250 50 kg  
24255 100 kg  
24258 150 kg

12

6

6

6

6

6

CSIPESZ KLT.  
PENSETE

INOX



50004 2 ks / pcs

1

ÜVEGTÁBLA FOGÓ  
VENTUZE PLACI STICLA



**36305**  
**36306** dupla/duble pentru



BEHÚZÓSZALAG  
CABLU GHIDARE (SARPE)



**51180** 5 mm x 4 m  
**51181** 5 mm x 8 m  
**51182** 5 mm x 10 m

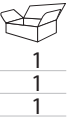

LEFOLYÓ TISZTÍTÓ  
FURTUN ELASTIC PENTRU CANAL



**50010** 3 m  
**50011** 5 m  
**50012** 10 m  
**50013** 15 m



LEFOLYÓ TISZTÍTÓ  
FURTUN ELASTIC PENTRU CANAL



**50009** 3 m / Ø 5 mm



TELESZKÓPOS RÚD  
MANER TELESCOPIC



**52010** 1,2 m ALU  
**52012** 2,4 m ALU



TELESKOPICKÁ TYČ  
TELESCOPIC POLES



**52020** 3 m fém/otel



TELESKOPICKÁ TYČ  
TELESCOPIC POLES



**52030** 2,4 m fiberglass/fibra de sticla



LEFOLYÓ-TISZTÍTÓ PUMPA  
POMPA ABSORBTIE



**50015**



SZEMÉTFELSZEDŐ  
UNEALTA CULES GUNOI

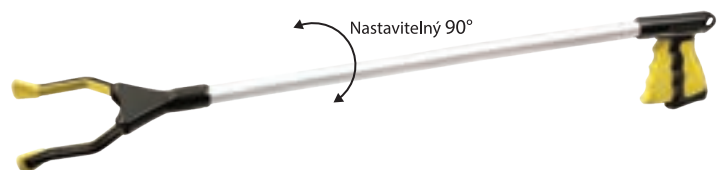

**61235** 81 cm

1

FELMOSÓ MOP  
MOP



52110 30 cm  
52111 tartalék mop/rezerva mop



20  
50

KAROS ZSÍRZÓ  
PISTOL DE VASELINA

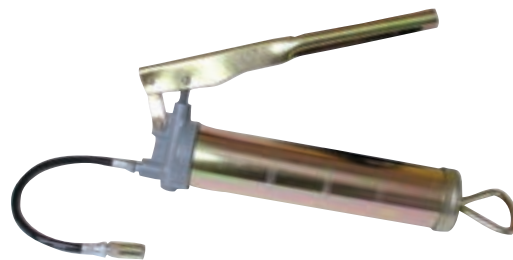

50022



20

OLAJZÓKANNA  
DISPOZITIV DE UNGERE



50020 300 ml



10

SZÜRŐ LESZEDŐ  
FILTRU

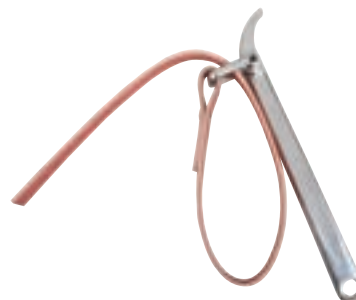

50021 60 x 140 mm



6

HORDÓPUMPA  
POMPA PENTRU CANISTRA



50017



10

PUMPA FÚRÓRA  
POMPA PENTRU MASINA DE GAURIT

FESTA®



20368



1

TÖLCSÉR  
PALNIE FLEXIBILA



50025



80

PUMPA FÚRÓRA  
POMPA PENTRU MASINA DE GAURIT



20367



48

EGÉRFOGÓ  
CAPCANA SOARECI LEMN



70221 90x45mm

2db/buc



1

EGÉRFOGÓ  
CAPCANA SOARECI PLASTIC



70220 97x47mm

2db/buc



1

▼ LÁMPA 3 LEDDEL  
LANTERNA 3 LED-URI



<b>37620</b>	135 mm, 3 x LED, baterie/batteries 3db/buc typ AAA	6
<b>37621</b>	185 mm, 3 x LED, baterie/batteries 2db/buc typ D	6
<b>37622</b>	245 mm, 3 x LED, baterie/batteries 3db/buc typ	6

▼ FEJLÁMPA, LEDDES  
LANTERNA LED PENTRU CAP



**37640**

1

▼ HORDOZHATÓ LÁMPA  
LÁMPA PORTABILA LED



**37643**

1

▼ AKU LÁMPA  
LANTERNA



**37650** H3 halogen, 6V/4Ah

1

KONZOL FEHÉR  
CONSOLA ALB

<b>81100</b>	100 x 75 mm	20
<b>81101</b>	125 x 100 mm	20
<b>81102</b>	150 x 125 mm	20
<b>81103</b>	200 x 150 mm	20
<b>81104</b>	250 x 200 mm	20
<b>81105</b>	300 x 250 mm	20
<b>81106</b>	350 x 300 mm	20

KONZOL BARNÁ  
CONSOLA MARO

<b>81110</b>	100 x 75 mm	20
<b>81111</b>	100 x 125 mm	20
<b>81112</b>	150 x 125 mm	20
<b>81113</b>	200 x 150 mm	20
<b>81114</b>	250 x 200 mm	20
<b>81115</b>	300 x 250 mm	20
<b>81116</b>	350 x 300 mm	20

POLCTARTÓ, EGYSZERŰ  
SUPORT VERTICAL

<b>81050</b>	15 cm	10
<b>81053</b>	50 cm	10
<b>81054</b>	80 cm	10
<b>81055</b>	100 cm	10
<b>81056</b>	150 cm	10
<b>81057</b>	200 cm	10

REGÁL KAMPÓ  
CONSOLA CLICK

<b>81070</b>	10 cm	40
<b>81071</b>	15 cm	40
<b>81072</b>	20 cm	30
<b>81073</b>	25 cm	20
<b>81074</b>	30 cm	20
<b>81075</b>	35 cm	20
<b>81076</b>	40 cm	20
<b>81077</b>	50 cm	20

ÖNTAPADÓS BLISZTER  
SUPORT AUTOADEZIV PREZENTARE

90103



1

BLISZTER  
SUPORT PREZENTARE

30000



1

BEMUTATÓ ÁLLVÁNY FESTA  
STAND FESTA

<b>81011</b>	állvány/stand 225x98x47cm	1
<b>81012</b>	holc/polita 97,5x30,5cm	1
<b>NEW 81019</b>	polc 40 cm	1
<b>81013</b>	horog/carlig 10 cm	1
<b>81014</b>	horog/carlig 16 cm	1
<b>81015</b>	horog/carlig 20 cm	1
<b>81016</b>	horog/carlig 30 cm	1



TARTÓ KERTI SZERSZÁMOK  
SUPPORT PENTRU UNELTE GRADINARIT

NEW



Illustration picture

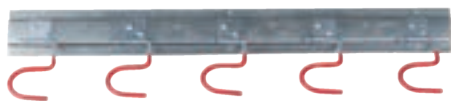

51185 50 cm



1







**FALÉTRA, KÉTÁGÚ**  
**SCARĂ DUBLĂ DIN LEMN**

<b>48570</b>	4 fokú/ treaptă	130 cm	1
<b>48571</b>	5 fokú/ treaptă	165 cm	1
<b>48572</b>	6 fokú/ treaptă	190 cm	1
<b>48573</b>	7 fokú/ treaptă	220 cm	1
<b>48574</b>	8 fokú/ treaptă	250 cm	1
<b>48575</b>	9 fokú/ treaptă	280 cm	1
<b>48576</b>	10 fokú/ treaptă	310 cm	1
<b>48577</b>	11 fokú/ treaptă	340 cm	1
<b>48578</b>	12 fokú/ treaptă	370 cm	1

**FESTŐLÉTRA**  
**SCARĂ DUBLĂ ZUGRAVI**



<b>48580</b>	4 fokú/ treaptă	145 cm	1
<b>48581</b>	5 fokú/ treaptă	180 cm	1
<b>48582</b>	6 fokú/ treaptă	207 cm	1
<b>48583</b>	7 fokú/ treaptă	240 cm	1
<b>48584</b>	8 fokú/ treaptă	273 cm	1
<b>48585</b>	9 fokú/ treaptă	306 cm	1
<b>48586</b>	10 fokú/ treaptă	339 cm	1
<b>48587</b>	11 fokú/ treaptă	372 cm	1
<b>48588</b>	12 fokú/ treaptă	405 cm	1

**FALÉTRA, KÉTÁGÚ**  
**SCARĂ DUBLĂ DIN LEMN**

<b>48552</b>	4 fokú/ treaptă	130 cm	1
<b>48553</b>	5 fokú/ treaptă	165 cm	1
<b>48554</b>	6 fokú/ treaptă	190 cm	1
<b>48555</b>	7 fokú/ treaptă	220 cm	1
<b>48556</b>	8 fokú/ treaptă	250 cm	1
<b>48557</b>	9 fokú/ treaptă	280 cm	1
<b>48558</b>	10 fokú/ treaptă	310 cm	1
<b>48559</b>	11 fokú/ treaptă	340 cm	1
<b>48560</b>	12 fokú/ treaptă	370 cm	1

**FESTŐLÉTRA**  
**SCARĂ DUBLĂ ZUGRAVI**

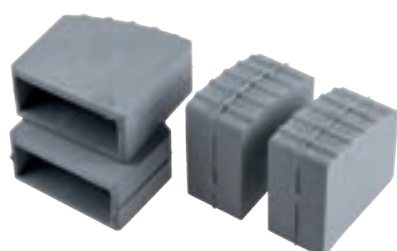
<b>48561</b>	4 fokú/ treaptă	145 cm	1
<b>48562</b>	5 fokú/ treaptă	180 cm	1
<b>48563</b>	6 fokú/ treaptă	207 cm	1
<b>48564</b>	7 fokú/ treaptă	240 cm	1
<b>48565</b>	8 fokú/ treaptă	273 cm	1
<b>48566</b>	9 fokú/ treaptă	306 cm	1
<b>48567</b>	10 fokú/ treaptă	339 cm	1
<b>48568</b>	11 fokú/ treaptă	372 cm	1
<b>48569</b>	12 fokú/ treaptă	405 cm	1

**GUMI MEGSZŰNIK LÉTRA**  
**ÎNCHIEIEREA DE CAUCIUC PENTRU SCARĂ PAS**

**48590** 4 db/ bud

1

GLETVAS ROZSDAMENTES  
GLETIERA INOX CU MANER CAUCIUC

 Kubala



INOX



**33100** 130 x 270, sima, 2x gömbölyű sarok/ rotunjit colt (0206) 1

GLETVAS ROZSDAMENTES  
GLETIERA INOX CU MANER CAUCIUC

 Kubala



INOX



**33102** 130x270, sima, G-1 markolat/ mâner (0473) 1

GLETVAS ROZSDAMENTES  
GLETIERA INOX CU MANER CAUCIUC

 Kubala



INOX



**33105** 130x350mm, sima, profesionalní G-8 markolat/ mâner (0489) 1

GLETVAS ROZSDAMENTES  
GLETIERA INOX CU MANER CAUCIUC

 Kubala



INOX



**33107** 110x270 mm, sarok /colț (0483) 1

GLETVAS ROZSDAMENTES  
GLETIERA INOX CU MANER CAUCIUC

 Kubala



INOX



**33110** 130x270mm, sima G-11 markolat/ mâner (0240) 1

GLETVAS ROZSDAMENTES  
GLETIERA INOX CU MANER CAUCIUC

 Kubala



INOX



**33112** 130x270mm, e6x6, G-11 markolat/ mâner (0242) 1  
**33113** 130x270mm, e8x8, G-11 markolat/ mâner (0243) 1  
**33114** 130x270mm, e10x10, G-11 markolat/ mâner (0244) 1

GLETVAS ROZSDAMENTES  
GLETIERA INOX CU MANER CAUCIUC

 Kubala



INOX



**33120** 130x480mm, sima, G 12 markolat/ mâner (0250) 1

GLETVAS ROZSDAMENTES  
GLETIERA INOX CU MANER CAUCIUC

 Kubala



INOX



**33122** 130x480mm, e 6x6, G-12 markolat/ mâner (0252) 1  
**33123** 130x480mm, e 8x8, G-12 markolat/ mâner (0253) 1  
**33124** 130x480mm, e 10x10, G-12 markolat/ mâner (0254) 1

GLETVAS ROZSDAMENTES  
GLETIERA INOX CU MANER CAUCIUC

 Kubala



INOX



**34127** 130x480mm, gömbölyű sarok/ rotunjit colt (0256) 5

GLETVAS ROZSDAMENTES  
GLETIERA INOX CU MANER CAUCIUC

 Kubala

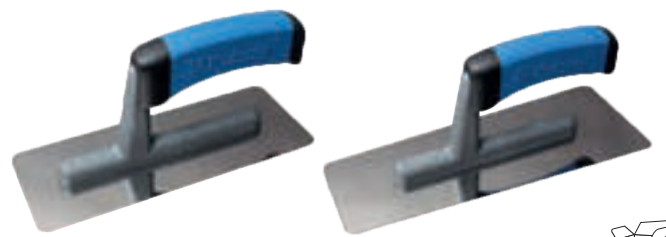

**33131** 80x200mm G-1 markolat/ mâner (0458) 20  
**33132** 75x95x240mm, G-1 markolat/ mâner (0459) 1

GLETVAS ROZSDAMENTES  
GLETIERA INOX CU MANER CAUCIUC

 Kubala



INOX



**33135** 130x270, horpadt/dințat 8 mm, G-1 markolat/mâner (0487) 1

GLETVAS ROZSDAMENTES  
GLETIERA INOX CU MANER CAUCIUC

 Kubala



INOX



**33137** 130x270mm, horpadt/dințat, G-1 markolat/mâner (0463) 1

GLETVAS ROZSDAMENTES  
GLETIERA INOX CU MANER CAUCIUC

 Kubala



INOX



**33138** 130x270mm, sima, markolat/mâner (2501) 1

GLETVAS ROZSDAMENTES  
GLETIERA INOX CU MANER CAUCIUC

 Kubala



INOX



**33139** 130x380mm, sima, markolat/mâner (2537) 1

GLETVAS ROZSDAMENTES  
GLETIERA INOX CU MANER CAUCIUC

 Kubala



INOX



**33140** 50 mm (0912) 1  
**33141** 60 mm (0902) 1  
**33142** 80 mm (0903) 1  
**33143** 100 mm (0904) 1

MŰANYAG SIMÍTÓ ERŐSÍTETT ABS  
GLETIERA ABS

 Kubala



INOX



**33150** 130x270mm (0300) 1

MŰANYAG SIMÍTÓ ERŐSÍTETT  
GLETIERA PLASTIC

 Kubala

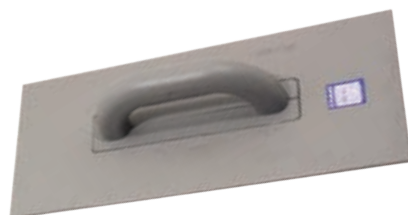

**33151** 180x400mm (0307) 1  
**33152** 130x600mm (0308) 1

MŰANYAG SIMÍTÓ ERŐSÍTETT  
GLETIERA PLASTIC

 Kubala



**33154** 130x270mm, G-17 ručka (0381) 5

MŰANYAG SIMÍTÓ ERŐSÍTETT  
GLETIERA PLASTIC

 Kubala



**33155** 95x240mm, gumi/ rubber (0325) 5

CSISZOLÓ TUSKÓ CSAVAROS  
SUPPORT PENTRU SLEFUIT

 Kubala



**33160** 105x210mm, gumi/ rubber (0306) 1

KAPARÓ RÉGI VAKOLATRA  
GLETIERA RAZUITOR

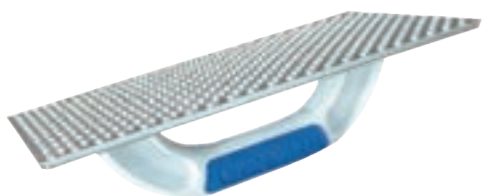

INOX



<b>33162</b>	130x270 mm (0335)	1
<b>33163</b>	180x400 mm (0321)	1
<b>33164</b>	160x380 mm (0340)	1

KAPARÓ RÉGI VAKOLATRA  
GLETIERA RAZUITOR

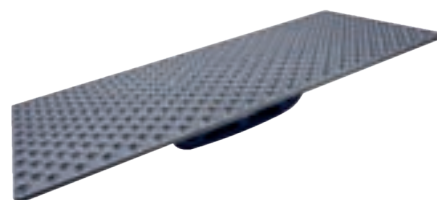

INOX



<b>33165</b>	165x365mm (0341)	1
--------------	------------------	---

KAPARÓ RÉGI VAKOLATRA  
GLETIERA RAZUITOR



INOX



<b>33166</b>	130x600mm (0338)	1
--------------	------------------	---

KAPARÓ RÉGI VAKOLATRA  
GLETIERA RAZUITORL



INOX



<b>33167</b>	130x270 mm, G- 17 markolat/ mâner (0344)	1
<b>33168</b>	160x380 mm, G- 17 markolat/ mâner (0343)	1
<b>33170</b>	180x400 mm, G- 17 markolat/ mâner(0345)	1

KAPARÓ RÉGI VAKOLATRA  
GLETIERA RAZUITOR



INOX



<b>33169</b>	160x380mm, G-16 markolat/ mâner(0342)	1
--------------	---------------------------------------	---

KAPARÓ PLASTIC  
PLASTIC SCRAPER WITH STUDS



INOX



<b>33173</b>	(1415)	1
--------------	--------	---

SPAKLI ROZSDAMENTES  
STAINLESS SPATULA



INOX



<b>33200</b>	40 mm (0501)	1
<b>33201</b>	60 mm (0502)	1
<b>33202</b>	80 mm (0503)	1
<b>33203</b>	100 mm (0500)	1

SPAKLI ROZSDAMENTES  
STAINLESS SPATULA



INOX



<b>33205</b>	130x90mm (0508)	5
--------------	-----------------	---

SPAKLI ROZSDAMENTES  
STAINLESS SPATULA



INOX



<b>33206</b>	130x37 mm (0509)	5
--------------	------------------	---

SPAKLI ROZSDAMENTESÁ  
STAINLESS SPATULA



INOX



<b>33207</b>	150mm, cserélhető bit/ bit inlocuibil (0545)	1
--------------	--	---

KAPARÓ ROZSDAMENTES  
SPACLU INOX CU MANER CAUCIUC

 Kubala



**33208** 350x90 mm (0512)



KAPARÓ ROZSDAMENTES  
SPACLU INOX CU MANER CAUCIUC

 Kubala



**33209** 335x37mm (0513)



KAPARÓ ROZSDAMENTES  
SPACLU INOX CU MANER CAUCIUC

 Kubala



INOX



**33210** 150 mm, G- 15 ručka (0546)

1

**33211** 250 mm, G- 15 ručka (0547)

1

**33212** 350 mm, G- 15 ručka (0548)

1

KAPARÓ ROZSDAMENTES  
SPACLU INOX CU MANER CAUCIUC

 Kubala



**33215** 600mm, AL uchycení, G-14 ručka (0535)



KAPARÓ  
SPACLU PLASTIC

 Kubala



**33220** 145mm, s gumou (0611)



KAPARÓ PLASTIC  
SPACLU PLASTIC

 Kubala



**33221** 245mm, s gumou (0612)



KOMPLET FESTÉKEK  
SET VOPSELE

 Kubala



**33250** (9901)



KOMPLET FESTÉKEK MINI  
SET VOPSELE MINI

 Kubala



**33252** (9907)



VÖDÖR  
RECIPIENT VOPSEA

 Kubala



**33254** 16l, rács/ gratar, kerék/ roți (1520)



**33255** 20l, rács/ gratar, kerék/ roți (1524)

1

PÓT HENGER  
REZERVA TRAFLET

 Kubala



**33256** henger do vödör/trafalet do recipient 1524 (1520)



**33258** henger do vödör/trafalet do recipient 1520 (1521)

1

PÓT HENGER  
REZERVA TRAFLET

Kubala



33257 henger do vödör/trafalet do recipient 1524, 1526 (1529) 1

KŐMŰVES SERPENYŐ MŰANYAG  
CANCIOC PLASTIC

Kubala



33270 175 mm, (3380) 1

RÁCS  
GRATAR PENTRU SCURS

Kubala

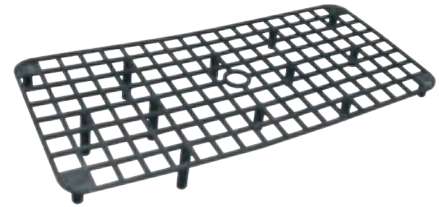

33259 mřížka do kbelíku 1512 (1519) 1

GIPSZELŐ EDÉNY  
VAS PENTRU GIPS

Kubala



33275 0,5l (1518) 1

KAPARÓ GUMI  
SPACLU RUBBER

Kubala



33280	200 mm (0602)	1
37010	135 mm (0601)	1
37019	250mm (0603)	1
37022	300mm (0603)	1
37023	400mm (0604)	1

FESTÉKKAPARÓ  
RAZUITOARE

Kubala



33285	60mm (1407)	1
33286	pót pengék/ lame rezerva 60mm (1413)	1

MŰGYANTA HENGER  
ROLA PLASTIC

Kubala



33289 85x230mm (1694) 1

FÚRÓ PORÓZUS  
BURGHIIU POROS

Kubala



33291	60mm (1721)	1
33292	80mm (1722)	1
33293	120mm (1723)	1

MŰANYAG GÉRVÁGÓ DOBOZ  
CUTIE DE PLASTIC MITRA

Kubala

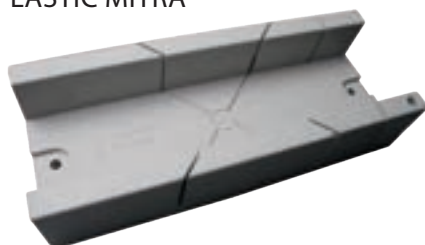

33298	250x80x50mm (1644)	1
33299	300x115x65mm (1645)	1



Magas színvonalú berendezések és felszerelések műhelyek és benzinkutak számára - szakembereknek és ezermestereknek.  
EU irányelv 98/37/EC, 2006/42/EC, 73/23/EEC, 93/68/EEC

Dispozitive si echipamente de calitate pentru ateliere de reparatii sau statii service profesioniste.  
Directiva UE 98/37/EC, 2006/42/EC, 73/23/EEC, 93/68/EEC

### HIDRAULIKUS EMELŐ CRIC HIDRAULIC TIP BUTELIE



A hosszabbító csavar lehetővé teszi a legalacsonyabb magasságállítást és a maximális emelkedést. Kettős biztonságú szelep. Fogazott nyereg lehetővé teszi a nagy felületű emelést és biztonságos fogást. A széles talp stabilitást és erőt biztosít. Minden modellen a nagy igénybevételnek kitett részek meg vannak erősítve, a tartósság és megbízhatóság érdekében.

Tija filetata permite prelungirea cursei si ajustarea inaltimii de ridicare. Dotat cu supapa bypass pentru siguranta sporita. Saau zimtata da o aderenta sporita si ofera o zona generoasa de sprijinire.

		Terhelhetőség / Capacitate (kg)	Min. magasság (mm) / Inaltime	Emelő magasság (mm) / Inaltime	Beigazítási magasság (mm) / Inaltime	Talp méretek (mm) / Dimensiuni baza	Súly (kg) / Greutate	
<b>26800</b>	Hidraulikus emelő / Cric hidraulic tip butelie	2 000kg	181	116	48	88x92	2,6kg	6
<b>26801</b>	Hidraulikus emelő / Cric hidraulic tip butelie	3 000kg	194	118	60	92x100	3,3kg	6
<b>26802</b>	Hidraulikus emelő / Cric hidraulic tip butelie	5 000kg	216	127	70	96x112	4,5kg	4
<b>26803</b>	Hidraulikus emelő / Cric hidraulic tip butelie	8 000kg	230	147	80	103x118	5,7kg	4
<b>26804</b>	Hidraulikus emelő / Cric hidraulic tip butelie	10 000kg	230	150	80	110x123	6,8kg	4
<b>26805</b>	Hidraulikus emelő / Cric hidraulic tip butelie	12 000kg	230	155	80	116x134	7,3kg	3
<b>26806</b>	Hidraulikus emelő / Cric hidraulic tip butelie	15 000kg	230	150	80	133x136	8,4kg	2
<b>26807</b>	Hidraulikus emelő / Cric hidraulic tip butelie	20 000kg	242	150	60	144x152	11,0kg	2

### KÉT DUGATTYÚS HIDRAULIKUS EMELŐ CRICURI HIDRAULICE DUBLE TIP BUTELIE



A hosszabbító csavar lehetővé teszi a legalacsonyabb magasságállítást és a maximális emelkedést. Kettős biztonságú szelep. Fogazott nyereg lehetővé teszi a nagy felületű emelést és biztonságos fogást. A széles talp stabilitást és erőt biztosít. Minden modellen a nagy igénybevételnek kitett részek meg vannak erősítve, a tartósság és megbízhatóság érdekében. A hosszabbító csavar lehetővé teszi a legalacsonyabb magasságállítást és a maximális emelkedést. Kettős biztonságú szelep. Fogazott nyereg lehetővé teszi a nagy felületű emelést és biztonságos fogást. A széles talp stabilitást és erőt biztosít. Minden modellen a nagy igénybevételnek kitett részek meg vannak erősítve, a tartósság és megbízhatóság érdekében.

Tija filetata permite ajustarea inaltimii de ridicare. Dotate cu supapa bypass pentru o siguranta sporita. Baza lata ofera stabilitate si rezistenta. Toate punctele critice sunt intarite pentru o durabilitate si fiabilitate cat mai mare.

		Terhelhetőség (kg) Capacitate (kg)	Min. magasság (mm) Inaltime min.	Emelő magasság (mm) Inaltime ridicare	Beigazítási magasság (mm) Inaltime reglabila	Súly (kg) Greutate	
<b>26815</b>	Két dugattyús hidraulikus emelő / Cric hidraulic dublu tip butelie	2 000kg	150	160	60	4,7kg	6
<b>26816</b>	Két dugattyús hidraulikus emelő / Cric hidraulic dublu tip butelie	4 000kg	160	170	60	6,4kg	4
<b>26817</b>	Két dugattyús hidraulikus emelő / Cric hidraulic dublu tip butelie	6 000kg	215	270	-	8,9kg	4
<b>26819</b>	Két dugattyús hidraulikus emelő / Cric hidraulic dublu tip butelie	10 000kg	228	284	89	10,2kg	2

### OLLÓS EMELŐ CRICURI TIP FOARFECA



	Terhelhetőség (kg) Capacitate	Min. magasság (mm) Inaltime min.	Max. magasság (mm) Inaltime max.	Súly (kg) Greutate	
<b>26844</b> Ollós emelő / Cric tip foarfeca	1 000kg	88	380	2,5kg	10
<b>26845</b> Ollós emelő / Cric tip foarfeca	2 000kg	120	395	3,5kg	10

### KOCSIS HIDRAULIKUS EMELŐ CRICURI HIDRAULICE PORTABILE



	Nosnost Capacity	Min. výchka (mm) Min. Height	Max. výchka (mm) Max. Height	Váha Weight	
<b>26820</b> Kocsis hidraulikus emelő / Cric hidraulic portabil	2 000kg	130	345	9,6 kg	1
<b>26826</b> Hidraulikus szerviz emelő, alacsony profil, 360°-ban elforgatható kar Cric hidraulic profil jos pentru service, maner rotativ 360°	2 000kg	89	359	14,2 kg	1
<b>26823</b> Hidraulikus szerviz emelő / Cric hidraulic portabil	3 000kg	145	520	37,6 kg	1
<b>26824</b> Hidraulikus szerviz emelő, pedálos Cric hidraulic service cu pedala	3 000kg	145	500	37,2 kg	1
<b>26825</b> Hidraulikus szerviz emelő, Cric hidraulic portabil profil jos, profi	2 500kg	85	455	34,8 kg	1
<b>26827</b> Hidraulikus szerviz emelő, Cric hidraulic profil jos , portabil, cu 2 pistoane	3 000kg	95	560	46,1 kg	1

### KOCSIS HIDRAULIKUS EMELŐ+TARTÓBAK SET CRIC HIDRAULIC SI CAPRE REGLABILE

360°-ban elforgatható nyél,

maner rotativ 360°



	Terhelhetőség (kg) Capacitate	Min. magasság (mm) Inaltime min	Max. magasság (mm) Inaltime max.	Súly (kg) Greutate	
<b>26829</b> Kocsis hidraulikus emelő / Cric hidraulic portabil 2 db állvány / 2 bucati capre reglabile	2 000kg	130	350	10,5kg	1
	2 000kg	275	420	5,0kg (pair)	

**KOCSIS HIDRAULIKUS EMELŐ, HOSSZÍTOTT**  
**CRICURI HIDRAULICE PORTABILE LUNGI**

Professzionális szerviz emelő, gyors emelő pedállal.

Cricuri profesional pentru statii service. Echipate cu pedala de actionare, pentru o ridicare rapida.



26835



26836



26837

Terhelhetőség (kg) Capacitate	Min. magasság (mm) Inaltime min	Max. magasság (mm) Inaltime max	Súly (kg) Greutate	
3 000kg	140	670	56,0 kg	1
5 000kg	150	560	87,0 kg	1
10 000kg	160	560	146,0 kg	1



<b>26835</b>	Kocsis hidraulikus emelő, hosszított / Cric hidraulic portabil lung
<b>26836</b>	Kocsis hidraulikus emelő, hosszított / Cric hidraulic portabil lung
<b>26837</b>	Kocsis hidraulikus emelő, hosszított / Cric hidraulic portabil lung

**TARTÓBAKOK**  
**CAPRE / STATIVE REGLABILE**

1 db=1 pár! Finoman állítható kilincsmű, dupla zárvédelemmel. Tömör acél fogantyú. Egységített vázszerkezet. Állítható vas állvány.

1 bucata = 1 pereche. Ridicare cu clichet si dubla blocare pentru o protectie sporita. Cadru rezistent la sarcini mari.



Terhelhetőség (kg) Capacitate	Min. magasság (mm) Inaltime min	Max. magasság (mm) Inaltime max	Súly/pár (kg) Greutate	
2 000kg	275	420	5,0kg	1
3 000kg	285	425	6,4kg	1
6 000kg	390	605	13,7kg	1
12 000kg	465	715	27,3kg	1



**HIDRAULIKUS KAROS EMELŐDARU**  
**MACARA HIDRAULICA**

Autóalkatrészek kiemelésére és rögzítésére a be- és kiszérés idejére. A daru gémje helyenként meghosszabbítható. A daru összezecsukható, így könnyen tárolható.

Pentru ridicarea si fixarea motoarelor pe timpul montarii/demontarii.



Terhelhetőség (kg) Capacitate	Min. magasság (mm) Inaltime min	Max. magasság (mm) Inaltime max	Súly (kg) Greutate	
2 000kg	0	2360	88,0kg	1



<b>26862</b>	Hidraulikus karos emelődaru, összezecsukható / Macara hidraulica, pliabila
--------------	--

**MOTOROS EMEŐ  
MACARA CU ECHILIBRARE**



A műhelydaruk számára kialakított emelőgenda láncokkal és acél szögekkel van ellátva, a motorok és egyéb terhek biztonságos rögzítésére.

Sistem de prindere si ridicare motor cu echilibrare

Súly  
(kg)  
Greutate



**26870** Motoros emelő / Macara cu echilibrare

680kg 5,5kg

1

**MOTORTARTÓ  
SUPPORT MOTOR**



A lengő kar felfüggesztése a kámsza dőlésének függvénye. Mindig kiegyensúlyozott és stabil motorrögzítést biztosít.

Suport motor cu echilibrare pentru sasiul masinii, asigura stabilitatea motorului pe timpul lucrului.

Hossz  
(mm)  
lungime

Beigazítási  
magasság  
(mm)  
Rand

Súly  
(kg)  
Greutate



**26871** Motortartó / suport motor

500kg 1500mm 150mm 20,3kg

1

**HIDRAULIKUS SEBESSÉGVÁLTÓ TARTÓ  
CRIC HIDRAULIC PENTRU TRANSMISII**



26880



26881

Egységek könnyű ki- és beszereléséhez (motorok, sebességváltók, tengelyek, stb.)

Pentru montarea/demontarea usoara a transmisiilor si motoarelor.

Min.  
magasság  
(mm)  
Inaltime min

Max.  
magasság  
(mm)  
Inaltime max

Súly  
(kg)  
Greutate



**26880** Hidraulikus sebességváltó tartó / Cric hidraulic pentru transmisii

500kg 1100 1900 30,0 kg

1

**26881** EMEŐHOSSZABÍTÓ AUTOMATA SEBESSÉGVÁLTÓHOZ/ Extensie pentru cric hidraulic transmisii

500kg 1100 1900 15,0 kg

1

**HIDRAULIKUS KAROSSZERIAJAVÍTÓ, HORDOZHATÓ  
ECHIPAMENT HIDRAULIC PORTABIL**



26886



26888

Hidraulikus berendezés karosszeriajavításhoz. Dugattyús hengerekkel ellátott készülék, 14 tartozékkal. Széles körben alkalmazható személy- és teherautók karosszériájának a javítására, különösen áramellátás nélküli helyszíneken. Vízszintesen és függőlegesen tolható, húzható, emelhető és feszíthető tartozékokkal. Könnyen szállítható az öntött, ütészálló hord táskával.

Echipament hidraulic pentru tinichigerie. Trusa contine un cric hidraulic si 14 accesorii. Este recomandat pentru reparatia caroseriilor fara a avea nevoie de alimentare cu energie. Usor de transportat in trusa.

Terhelhetőség  
(kg)  
Capacitate

Hidro  
emelő  
(mm)  
Hydr. lift

Súly  
(kg)  
Greutate



**26886** Hordozható hidraulikus karosszeriajavító / Echipament hidraulic portabil

4 000kg 125 17,0kg

1

**26888** Hordozható hidraulikus karosszeriajavító / Echipament hidraulic portabil

10 000kg 135 32,0kg

1

### MOTORTARTÓ ÁLLVÁNY STATIV MOTOR



26920



26921



26922

Mozgatható állvány motorok szétszereléséhez és javításához. Univerzális befogó egység a motorok rögzítésére és forgatására.

Stand mobil pentru montarea si lucrul la demontarea motoarelor. Unitati de prindere universala pentru fixarea motoarelor si rotirea lor.

		Súly (kg)	Greutate	
<b>26920</b>	Motortartó állvány, állítható, mozgatható / Stativ motor, pozitionare, mobil	450kg	20,0kg	1
<b>26921</b>	Motortartó állvány, állítható, mozgatható / Stativ motor, pozitionare, mobil	560kg	27,0kg	1
<b>26922</b>	Motortartó állvány, állítható, mozgatható, összecukható / Stativ motor, pozitionare, mobil, pliabil	675kg	35,0kg	1

### KÉZI CSÖRLŐ TROLIU MANUAL



Kiváló minőségű horganyzott csörlő, tartós drótkötéllel.

Troliu de inalta calitate, zincat, cu cablu durabil.

	Max.terhelhetőség (kg) Capacitate max.	Kötél hossz (m) Lungime cablu	Kötél átmérő (mm) Diametru cablu	Zn	
<b>26705</b>	Kézi csörlő / Troliu manual	450kg	10,0m	4,0mm	1
<b>26706</b>	Kézi csörlő / Troliu manual	900kg	10,0m	5,0mm	4
<b>26707</b>	Kézi csörlő / Troliu manual	1350kg	10,0m	6,0mm	4
<b>26720</b>	Kézi csörlő / Troliu manual	300kg	10,0m	4,0mm	8
<b>26721</b>	Kézi csörlő / Troliu manual	500kg	10,0m	4,0mm	8
<b>26722</b>	Kézi csörlő / Troliu manual	800kg	10,0m	5,0mm	4

### HIDRAULIKUS MŰHELY PRÉS PRESA HIDRAULICA CU CRIC



Terhelhetőség (kg) Capacitate	Tartomány (mm) Rand	Súly (kg) Greutate
12 000kg	0-910mm	43,0kg
20 000kg	0-1080mm	75,0kg

<b>26940</b>	Hidraulikus műhely prés / Presa hidraulica cu cric	12 000kg	0-910mm	43,0kg	1
<b>26941</b>	Hidraulikus műhely prés / Presa hidraulica cu cric	20 000kg	0-1080mm	75,0kg	1

### RUGÓ ÖSSZENYOMÓ PRESA ARCURI



26897 - McPherson rugóstagok/rugók járműn kívüli cseréjéhez.

26897 - Pentru a inlocui arcuiri direct pe masina.

26943 - McPherson rugóstagok/rugók járműn kívüli cseréjéhez. Erős acél profilok a nagyobb stabilitásért.

26943 - Pentru a inlocui arcuiri in afara vehiculului. Profile de oțel pentru mai multa stabilitate.

**26897** HIDRAULIKUS RUGÓ ÖSSZEHÚZÓ / Presa arcuiri  
**26943** RUGÓ ÖSSZEHÚZÓ / Presa arcuiri

Terhelhetőség (kg) Capacitate	Ø Összenyomott rugó (mm) Ø Compressed Spring	Összenyomó hossz (mm) Lungime	Súly (kg) Greutate
1 000kg	100-200	150	24,5kg
1 000kg	400	210-570	35,0kg



### LÁNCOS EMELŐCSIGA LANT CU PIEDICA



**26700** Láncos emelő / Vinci cu lant  
**26701** Láncos emelő / Vinci cu lant  
**26702** Láncos emelő / Vinci cu lant

Terhelhetőség (kg) Capacitate	Min. magasság (mm) Inaltime ridicare	Emelési magasság (mm) Inaltime ridicare	Emelőcsigák száma Numar piedica lant	Síla rētezu (mm) Grosime lant	Súly (kg) Greutate
500kg	280mm	3 000mm	1	6,0mm	7,5kg
1 000kg	300mm	3 000mm	1	6,0mm	9,0kg
2 000kg	380mm	3 000mm	2	6,0mm	12,0kg



### HIDRAULIKUS CSÓHAJLÍTÓ PRESA HIDRAULICA TEVI



**26895** Hordozható hidraulikus csóhajlító  
Presa hidraulica portabila pentru tevi  
**26896** Hordozható hidraulikus csóhajlító  
Presa hidraulica portabila pentru tevi

Terhelhetőség (kg) Capacitate	Hidraulikus emelő (mm) Hydraulic lift	Súly (kg) Greutate	Hajlító pofa / Indoire potcoava
12 000kg	232	36,0kg	1/2", 3/4", 1", 1-1/4", 1-1/2", 2"
16 000kg	238	65,0kg	1/2", 3/4", 1", 1-1/4", 1-1/2", 2", 2-1/2", 3"



### HIDRAULIKUS TARTÓS PRÉS CRIC HIDRAULIC LUNG



26911, 26912



26914, 26915



26916 - Pneumatikus nyomásfokozóval, 0,75-0,85 Mpa nyomással.  
Cu multiplicator pneumatic, presiune de lucru 0,75 - 0,85 Mpa.

Terhelhetőség (kg) Capacitate	Min. hossz (mm) Min.lungime	Max. magasság (mm) Max.lungime	Súly (kg) Greutate
----------------------------------	--------------------------------	-----------------------------------	-----------------------



<b>26911</b>	Hidraulikus tartós prés, egy pumpás / Cric hidraulic lung, monopompa	5 000kg	620	1100	12,0kg	2
<b>26912</b>	Hidraulikus tartós prés, egy pumpás / Cric hidraulic lung, monopompa	8 000kg	620	1100	13,0kg	2
<b>26914</b>	Hidraulikus tartós prés, egy pumpás / Cric hidraulic lung, pompa dubla	5 000kg	620	1100	12,0kg	2
<b>26915</b>	Hidraulikus tartós prés, egy pumpás / Cric hidraulic lung, pompa dubla	8 000kg	620	1100	14,0kg	2
<b>26916</b>	Hidraulikus tartós prés nyomásfokozóval / Cric hidraulic lung cu multiplicator pneumatic	8 000kg	620	1100	14,5kg	1

### HIDRAULIKUS CSAPÁGYLEHÚZÓ SET HIDRAULIC PENTRU DEPRESARE



Hidraulikus lehúzó készlet. Hidraulikus csavarral, befogópofával, 3 körmös lehúzóval és feszítővel és ölel. Acél kofferben.

Set hidraulic pentru depresare. Contine minipresa hidraulica, 3 perechi de gheare de prindere, ghidaje si cleme de fixare. Trusa metalica rezistenta

Terhelhetőség (kg) Capacitate	Súly (kg) Greutate
----------------------------------	-----------------------



<b>26891</b>	Univerzális hidraulikus csapágylehúzó készlet / Set hidraulic pentru depresare	12 000kg	18,0kg	1
--------------	--	----------	--------	---

### CSAPÁGYLEHÚZÓ PENTRU DEPRESARE



<b>23730</b>	100 mm	1
<b>23731</b>	150 mm	1
<b>23732</b>	200 mm	1

### OLAJ LEERESZTŐ TARTÁLY EXTRACTOR ULEI CU REZERVOR



A motorból leeresztett olaj a tölcseren keresztül kerül a tartályba. Tartállyal szerelve. A fáradt olaj egy csövön keresztül kiszivattyúzható a tartályból.

Oleiul din baia de ulei poate fi extras prin joja de ulei cu ajutorul colectorului. Pomparea se va face folosind aer comprimat

Terhelhetőség (l) Capacitate	Max. nyomás (MPa) Max presiune	Súly (kg) Greutate
---------------------------------	-----------------------------------	-----------------------



<b>26953</b>	Olajleeresztő tartály / Extractor ulei cu rezervor	90 l	0,2MPa	22,0kg	1
--------------	--	------	--------	--------	---

### FÁRADT OLAJ ELSZÍVÓ EXTRACTOR ULEI CU REZERVOR SI TAVA



A motorból leeresztett olaj a tölcseren keresztül kerül a tartályba. A tartály elszívó berendezéssel van ellátva. A fáradt olaj egy csövön keresztül kiszivattyúzható a tartályból.

Uleiul din baia de ulei poate fi extras prin joja de ulei cu ajutorul colectorului. Pomparea se va face folosind aer comprimat

Terhelhetőség (l) Capacitate	Max. nyomás (bar) Max. presiune	Súly (kg) Greutate
90 l	0,5bar	28,0kg



1

**26954** Fáradt olaj elszívó / Extractor ulei cu rezervor si tava

### ALKATRÉSZMOSÓ SPALATOR PIESE



26961



26963

Általános tárgyak mosására (alkatrészek, tartozékok, stb.).

Pentru spalare diverse obiecte (piese, accesorii etc.)

Tartály kapacitás (l) Capacitate rezervor	Oldószer kapacitás (l) Capacitate solvent	Áramlási sebesség / Debit	Max. oldószer hőmérséklet / Temperatura max. solvent	Súly (kg) Greutate
75 l	45 l	10-12 l/min.	50°C	25,0kg
200 l	150 l	20 l/min.	50°C	42,0kg



1

**26961** Alkatrészmosó / Spalator piese

**26963** Alkatrészmosó / Spalator piese

### CSISZOLÓ SZEKRÉNY CABINET SABLARE



Levegőfogyasztás  
Consum de aer

Külső méret  
(mm)  
Dimensiuni exterioare

Belső méret  
(mm)  
Dimensiuni interioare

Max. nyomás  
(bar)  
Presiune max.

Súly  
(kg)  
Greutate

**26972** Csiszoló szekrény / Cabinet sablare

420-710 l/min.

1500x830x630 mm

600x840x630 mm

8 bar

38,0kg



1



### SZERSZÁMOS SZEKRÉNY DULAP PENTRU SCULE

A felső rész a görgős szekrényre helyezhető.

Partea superioara poate fi montata pe un cadru mobil



	Fiókok csúszása Dispozitiv sertare	Fiókok száma Sertare	Fiókok belső mérete (mm) Dimensiuni interioare sertar WxDxH	Teljes méret Dimensiuni totale (mm)	Összsúly Total Greutate (kg)	
<b>26985</b> Felső szekrény/ Partea de sus	Egyenletes Neted	3 2 1	151,5x225x40mm 511x225x40mm 511x225x85mm	600x260x340mm	11,5kg	1
Alsó szekrény/Partea de jos	Egyenletes/Neted	2	511x308x85mm	616x330x742mm	16,4kg	

### MÁGNESES TÁLCA TAVA MAGNETICA



Belső méretek  
(mm)  
Dimensiuni interioare



**26996** Mágneses tálca / Tava magnetica 200x20 mm 1

### TÉRDVÉDŐ PAD, GÖRGŐS CARUCIOR GENUCHI



**37135** Térdvédő pad / Carucior genuchi 1

### FEKPAD, GURULÓS PAT MOBIL MECANIC



Méreték  
(mm)  
Dimensiuni

**26936** Acél kúszópad / Pat mobil mecanic cadru otel

930x440x105 mm

1

### FEKPAD, GURULÓS PAT MOBIL MECANIC



Műanyag kúszópad bélelt fejtámlával. Oldalsó szer-  
számartartóval.

Targa pentru inspectie sub masina de platic cu par-  
tea capului captusita.

Méreték  
(mm)  
Dimensiuni

**26934** Öntött kúszópad / Pat mobil cu tava pentru scule

1030x450x105 mm

1

▼ FEKPAD, GURULÓS  
PAT MOBIL MECANIC



Bélelt kúszópad állítható fejtámlával és szerszám-tartóval.

Pat mobil mecanic cu tavi laterale si tetiera ajustabila.

Méreték  
(mm)  
Dimensiuni



**26938** Acél kúszópad / Pat mobil mecanic

1030x440x105 mm

▼ REKLAPEMELŐ  
CAMION PALLETI



**27000** AL- G/PU T1150 2t

1

▼ GÖRGŐS ÜLŐKE  
SCAUN PE ROLE

Bélelt görgős ülőke műanyag szerszám-tartóval.

Scaun pe role captusit cu tava pentru instrumente.



Méreték  
(mm)  
Dimensiuni

360 x 365 x 365 mm



**26988** Görgős ülőke / scaun pe role

1

▼ MOTORTARTÓ ÁLLVÁNY  
SUPORT MINI PENTRU RIDICAT



**26979**

1

▼ MOTORKERÉKPÁR EMELŐ ÁLLVÁNY  
SUPORT MINI PENTRU MOTOCICLETE



**26997**

1

▼ HYDRAULIKUS MINI EMELŐGÉP  
SUPORT MINI PENTRU RIDICAT



**26998**

1

▼ HYDRAULIKUS MINI EMELŐGÉP, JÁRÓSZERKEZETTEL  
MINI LEVIER PENTRU RIDICARE REVICE



**26999**

1



















Cikkszám/ Cod produs	oldal/ pagina	Cikkszám/ Cod produs	oldal/ pagina	Cikkszám/ Cod produs	oldal/ pagina	Cikkszám/ Cod produs	oldal/ pagina
81230	232	81318	232	81407	233	89970	233
81231	232	81319	232	81408	233	89973	233
81232	232	81320	232	81409	233	89973	233
81233	232	81321	232	81410	233	89980	233
81234	232	81322	232	81411	233	89980	233
81235	232	81323	232	81412	233	89985	233
81236	232	81324	232	81413	233	89985	233
81237	232	81325	232	81414	233	89987	233
81238	232	81326	232	81415	233	89987	233
81239	232	81327	232	81416	233	90070	233
81240	232	81328	232	81417	233	90071	233
81241	232	81329	232	81418	233	90072	233
81242	232	81330	232	81419	233	90103	233
81243	232	81331	232	81420	232		
81244	232	81332	232	81421	233		
81245	232	81333	232	81422	233		
81246	232	81334	232	81423	233		
81247	232	81335	232	81424	233		
81248	232	81336	232	81425	233		
81249	232	81337	232	81426	233		
81250	232	81338	232	81427	233		
81251	232	81339	232	81428	233		
81252	232	81340	232	81429	233		
81253	232	81341	232	81430	233		
81254	232	81342	232	81431	233		
81255	232	81343	232	81432	233		
81256	232	81344	233	81433	233		
81257	232	81345	233	81434	233		
81258	232	81346	233	81435	233		
81259	232	81347	232	81436	233		
81260	232	81348	232	81437	233		
81261	232	81349	232	81438	233		
81262	232	81350	232	81439	233		
81263	232	81351	232	81440	233		
81264	232	81352	232	81441	233		
81265	232	81353	232	81442	233		
81266	232	81354	232	81443	233		
81266	232	81355	232	81444	233		
81267	232	81356	232	81445	233		
81268	232	81357	232	81446	233		
81269	232	81358	232	81447	233		
81270	232	81359	232	81448	233		
81271	232	81360	232	81449	233		
81272	232	81361	232	81450	233		
81273	232	81362	232	81451	233		
81274	232	81363	232	81452	233		
81275	232	81364	232	81453	233		
81276	232	81365	232	81454	233		
81277	232	81366	232	81455	233		
81278	232	81367	232	81456	233		
81279	232	81368	232	81457	233		
81280	232	81369	233	81458	233		
81281	232	81370	233	81459	233		
81282	232	81371	233	81460	233		
81283	232	81372	233	81461	233		
81284	232	81373	233	81462	233		
81285	232	81374	233	81463	233		
81286	232	81375	233	81465	233		
81287	232	81376	233	81466	233		
81288	232	81377	233	81467	233		
81289	232	81378	233	81468	233		
81290	232	81379	233	81469	233		
81291	232	81380	233	81470	233		
81292	232	81381	233	81471	233		
81293	232	81382	233	81472	233		
81294	232	81383	233	81473	233		
81295	232	81384	233	81474	233		
81296	232	81385	233	81475	233		
81297	232	81386	233	81476	233		
81298	232	81387	233	81477	233		
81299	232	81388	233	81478	233		
81300	232	81389	233	81489	232		
81301	232	81390	233	82015	233		
81302	232	81391	233	82020	233		
81303	232	81392	233	82030	233		
81304	232	81393	233	82040	233		
81305	232	81394	233	82050	233		
81306	232	81395	233	82060	233		
81307	232	81396	233	82100	233		
81308	232	81397	233	82101	233		
81309	232	81398	233	82102	233		
81310	232	81399	233	82103	233		
81311	232	81400	233	82104	233		
81312	232	81401	233	82105	233		
81313	232	81402	233	82106	233		
81314	232	81403	232	82107	233		
81315	232	81404	233	82108	233		
81316	232	81405	233	82109	233		
81317	232	81406	233	89970	233		

# flexovit

Flexovit Hungária Kft.

## ELÉRHETŐSÉGEK



A képek illusztrációk, a termékek valós megjelenése eltérő lehet. Az esetleges nyomdahibákért felelősséget nem vállalunk. A Flexovit Hungária Kft. fenntartja a tévedések és a változások jogát. Bővebb információért keresse ügyfélszolgálatunkat.

### Flexovit Hungária Kft.

6728 Szeged, Dorozsmai út 48. - Tel/Fax: +36 62/ 462 949, +36 20 455 6005

E-mail: [flexovit@flexovit.hu](mailto:flexovit@flexovit.hu) - Web: [www.flexovit.hu](http://www.flexovit.hu)